



DG6000 Series

Function/Arbitrary Waveform Generator

User Guide

Jan. 2026

Guaranty and Declaration

Copyright

© 2026 RIGOL TECHNOLOGIES CO., LTD. All Rights Reserved.

Trademark Information

RIGOL® is the trademark of RIGOL TECHNOLOGIES CO., LTD.

Notices

- RIGOL products are covered by P.R.C. and foreign patents, issued and pending.
- RIGOL reserves the right to modify or change parts of or all the specifications and pricing policies at the company's sole decision.
- Information in this publication replaces all previously released materials.
- Information in this publication is subject to change without notice.
- RIGOL shall not be liable for either incidental or consequential losses in connection with the furnishing, use, or performance of this manual, as well as any information contained.
- Any part of this document is forbidden to be copied, photocopied, or rearranged without prior written approval of RIGOL.

Product Certification

RIGOL guarantees that this product conforms to the national and industrial standards in China as well as the ISO9001:2015 standard and the ISO14001:2015 standard. Other international standard conformance certifications are in progress.

Contact Us

If you have any problem or requirement when using our products or this manual, please contact RIGOL.

E-mail: service@rigol.com

Website: <http://www.rigol.com>

Section	Description	Page
	List of Figures.....	V
	List of Tables.....	VIII
1	Safety Requirement	1
1.1	General Safety Summary	1
1.2	Safety Notices and Symbols	3
1.3	Measurement Category	3
1.4	Ventilation Requirement	4
1.5	Working Environment	4
1.6	Care and Cleaning	6
1.7	Environmental Considerations	6
2	Product Features	8
3	Document Overview	9
4	Quick Start	11
4.1	General Inspection	11
4.2	Appearance	11
4.3	Dimensions	12
4.4	Product Overview	13
4.4.1	Front Panel Overview	13
4.4.2	Rear Panel Overview	19
4.4.3	2-Channel Model User Interface Overview	20
4.4.4	4-Channel Model User Interface Overview	23
4.5	To Prepare for Use	28
4.5.1	To Adjust the Supporting Legs	28
4.5.2	To Connect to Power	29
4.5.3	Turn-on Checkout	29
4.5.4	To Set the System Language	30
4.6	Touch Screen Gestures	30
4.6.1	Tap	30
4.6.2	Drag	31
4.7	Parameter Setting Method	31
4.7.1	To Set Parameters with the Front-panel Keys and Knobs	32
4.7.2	To Set Parameters with the Touch Screen	34
4.8	To Replace the Fuse	36

4.9 To Use the Security Lock	36
4.10 To Use the Built-in Help System	37
4.11 To View the Option Information and the Option Installation	37
5 Continuous	39
5.1 To Output Sine Wave	41
5.2 To Output Square Wave	44
5.3 To Output Ramp Wave	47
5.4 To Output Pulse	49
5.5 To Output Noise	52
5.6 To Output DC (SND Only)	53
5.7 To Output Arbitrary Waveforms	54
5.8 To Output Harmonic	62
6 Modulation	66
6.1 Amplitude Modulation (AM)	67
6.2 Frequency Modulation (FM)	69
6.3 Phase Modulation (PM)	70
6.4 Amplitude Shift Keying (ASK)	72
6.5 Frequency Shift Keying (FSK)	73
6.6 Phase Shift Keying (PSK)	75
6.7 Pulse Width Modulation (PWM)	76
6.8 SUM Modulation	78
7 Sweep	80
7.1 Sweep Type	80
7.2 Start Frequency and Stop Frequency	82
7.3 Center Frequency and Frequency Span	83
7.4 Sweep Time	84
7.5 Start/Stop Hold Time	84
7.6 Return Time	85
7.7 Sweep Trigger Source	85
7.8 Mark Frequency	86
8 Burst	87
8.1 Burst Type	88
8.2 Burst Delay	89
8.3 Burst Phase	89
8.4 Burst Period	90
8.5 Burst Trigger Source	90
8.6 Gated Polarity	91

8.7 Idle Level	91
9 Advanced Mode	93
9.1 Arb	93
9.2 Sequence	95
9.2.1 New Sequence	96
9.2.2 Output Rules	98
9.2.3 To Save/Load Sequence	100
9.2.4 To Set Sequence Parameters	101
9.3 PRBS	102
9.4 Multi-pulse	104
9.5 Multi-tone	107
9.6 Pattern	110
9.7 IQ Waveform	113
10 Arb Build	118
11 Output Type	121
12 Channel Setup	122
12.1 Sync Signal Setup	122
12.2 Trigger Output Setup	125
12.3 Channel Output Setup	125
13 Channel Copy	129
14 Bundle By Source Setup	133
14.1 Coupling Setup	134
14.2 Track Setup	137
15 Align Phase	139
16 Storage Management	141
16.1 To Select the File	141
16.2 To Transfer Files with FTP	142
16.3 To Create New Folder	144
16.4 Cut and Copy	144
16.5 Rename	144
16.6 Delete	144
17 Upgrade	145
18 System Utility Function Setting	146
18.1 I/O Setting	146
18.2 LXI	148
18.3 Basic Settings	148
18.4 About this Instrument	150

18.5	Print Screen	151
18.6	Option	151
18.7	Open Source Acknowledgment	152
18.8	Self-check	152
19	Preset Function	153
20	Remote Control	159
20.1	Remote Control via USB	160
20.2	Remote Control via LAN	160
21	Troubleshooting	162
22	Appendix	164
22.1	Appendix A: Options and Accessories	164
22.2	Appendix B: Warranty	165

List of Figures

Figure 4.1 Front Panel	11
Figure 4.2 Rear Panel	12
Figure 4.3 Front View	12
Figure 4.4 Side View	13
Figure 4.5 Front Panel (4-channel)	13
Figure 4.6 Front Panel (2-channel)	14
Figure 4.7 Rear Panel	19
Figure 4.8 2-Channel Model User Interface - 4-Channel Display Mode (Single-ended)	21
Figure 4.9 4-Channel Model User Interface - Single-Channel Display Mode	23
Figure 4.10 4-Channel Model User Interface - 2-Channel Display Mode	24
Figure 4.11 4-Channel Model User Interface - 4-Channel Display Mode	25
Figure 4.12 4-Channel Model User Interface - 8-Channel Display Mode (Single-ended)	26
Figure 4.13 8-Channel Display Mode Parameter Setting Interface	26
Figure 4.14 Adjust the Supporting Legs	29
Figure 4.15 Connect to Power	29
Figure 4.16 Tap Gesture	31
Figure 4.17 Drag Gesture	31
Figure 4.18 String Keypad	34
Figure 4.19 Numeric Keypad	35
Figure 4.20 Replace the Fuse	36
Figure 4.21 Use the Security Lock	37
Figure 5.1 Continuous Setting Interface	39
Figure 5.2 Harmonic Setting Interface	63
Figure 5.3 Table Editing Menu	64
Figure 6.1 Modulation Setting Interface	66

Figure 7.1 Sweep Setting Interface	80
Figure 7.2 Linear Sweep	81
Figure 7.3 Logarithmic Sweep	81
Figure 7.4 Step Sweep	82
Figure 7.5 Sweep	84
Figure 8.1 Burst Setting Interface	87
Figure 9.1 Advanced Waveform Setting Interface	93
Figure 9.2 Arb Setting Interface (Advanced Mode)	94
Figure 9.3 Sequence Setting Interface	96
Figure 9.4 Sequence Editing Table	96
Figure 9.6 PRBS Setting Interface	103
Figure 9.7 Multi-pulse Setting Interface	105
Figure 9.8 Multi-pulse Setting Menu	105
Figure 9.9 Multi-tone Setting Interface	108
Figure 9.10 Multi-tone Setting Menu	109
Figure 9.11 Pattern Setting Interface	110
Figure 9.12 Pattern Setting Menu	111
Figure 9.13 Block Diagram of IQ Modulation	114
Figure 9.14 IQ Setting Interface	114
Figure 9.15 IQ Setting Menu	115
Figure 10.1 Arb Build Interface	118
Figure 12.1 Channel Setup Interface	122
Figure 13.1 Channel Copy Menu	129
Figure 14.1 Bundle By Source Menu	133
Figure 14.2 Coupling Setup Interface	134
Figure 14.3 Channel Track Setup Interface	138
Figure 15.1 Before Aligning Phase	139
Figure 15.2 After Aligning Phase	140
Figure 16.1 Create Session	143

Figure 19.1 Preset Menu 153

List of Tables

Table 5.1 Range of Continuous Waveform Frequency	39
Table 5.2 SND Output Amplitude Range	40
Table 5.3 AMP Output Amplitude Range (Load)	41
Table 5.4 HBW Output Amplitude Range (Load)	41
Table 5.7 Built-in Waveforms	55
Table 6.1 Carrier Frequency Range (Modulation Mode)	66
Table 7.1 Sweep Start/Stop Frequency Range	82
Table 8.1 Carrier Frequency Range (Burst Mode)	88
Table 9.1 PRBS Polynomial Expression	102
Table 9.2 Pattern Preset Amplitude (SND, HighZ)	111
Table 12.1 Sync Signal of Different Output Modes (Positive Polarity)	123
Table 13.1 Multi-channel Operation Parameters	129
Table 19.1 Factory Settings	154

1 Safety Requirement

1.1 General Safety Summary

Please review the following safety precautions carefully before putting the instrument into operation so as to avoid any personal injury or damage to the instrument and any product connected to it. To prevent potential hazards, please follow the instructions specified in this manual to use the instrument properly.

- **Use the BNC Output Connectors Properly.**

The front-panel BNC output connectors only allow signal output but do not support signal input.

- **Use Proper Power Cord.**

Only the exclusive power cord designed for the instrument and authorized for use within the local country could be used.

- **Ground the Instrument.**

The instrument is grounded through the Protective Earth lead of the power cord. To avoid electric shock, it is essential to connect the earth terminal of the power cord to the Protective Earth terminal before connecting any inputs or outputs.

- **Observe All Terminal Ratings.**

To avoid fire or shock hazard, observe all ratings and markers on the instrument and check your manual for more information about ratings before connecting the instrument.

- **Use Proper Overvoltage Protection.**

Ensure that no overvoltage (such as that caused by a bolt of lightning) can reach the product. Otherwise, the operator might be exposed to the danger of an electric shock.

- **Do Not Operate Without Covers.**

Do not operate the instrument with covers or panels removed.

- **Do Not Insert Objects Into the Air Outlet.**

Do not insert anything into the holes of the fan to avoid damaging the instrument.

- **Use Proper Fuse.**

Please use the specified fuses.

- **Avoid Circuit or Wire Exposure.**

Do not touch exposed junctions and components when the unit is powered on.

- **Do Not Operate With Suspected Failures.**

If you suspect damage occurs to the instrument, have it inspected by RIGOL authorized personnel before further operations. Any maintenance, adjustment or replacement especially to circuits or accessories must be performed by RIGOL authorized personnel.
- **Provide Adequate Ventilation.**

Inadequate ventilation may cause an increase of temperature in the instrument, which would cause damage to the instrument. So please keep the instrument well ventilated and inspect the air outlet and the fan regularly.
- **Do Not Operate in Wet Conditions.**

To avoid short circuit inside the instrument or electric shock, never operate the instrument in a humid environment.
- **Do Not Operate in an Explosive Atmosphere.**

To avoid personal injuries or damage to the instrument, never operate the instrument in an explosive atmosphere.
- **Keep Instrument Surfaces Clean and Dry.**

To avoid dust or moisture from affecting the performance of the instrument, keep the surfaces of the instrument clean and dry.
- **Prevent Electrostatic Impact.**

Operate the instrument in an electrostatic discharge protective environment to avoid damage induced by static discharges. Always ground both the internal and external conductors of cables to release static before making connections.
- **Use the Battery Properly.**

Do not expose the battery (if available) to high temperature or fire. Keep it out of the reach of children. Improper change of a battery (lithium battery) may cause an explosion. Use the RIGOL specified battery only.
- **Handle with Caution.**

Please handle with care during transportation to avoid damage to keys, knobs, interfaces, and other parts on the panels.

**WARNING**

Equipment meeting Class A requirements may not offer adequate protection to broadcast services within residential environment.

1.2 Safety Notices and Symbols

Safety Notices in this Manual:



WARNING

Indicates a potentially hazardous situation or practice which, if not avoided, will result in serious injury or death.



CAUTION

Indicates a potentially hazardous situation or practice which, if not avoided, could result in damage to the product or loss of important data.

Safety Notices on the Product:

- **DANGER**
It calls attention to an operation, if not correctly performed, could result in injury or hazard immediately.
- **WARNING**
It calls attention to an operation, if not correctly performed, could result in potential injury or hazard.
- **CAUTION**
It calls attention to an operation, if not correctly performed, could result in damage to the product or other devices connected to the product.

Safety Symbols on the Product:



Hazardous Voltage



Safety Warning



Protective Earth Terminal

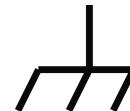

Chassis Ground

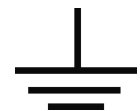

Test Ground

1.3 Measurement Category

Measurement Category

This instrument can make measurements in Measurement Category I.



WARNING

This instrument can only be used for measurements within its specified measurement categories.

Measurement Category Definitions

- **Measurement category I** is for measurements performed on circuits not directly connected to MAINS. Examples are measurements on circuits not derived from MAINS, and specially protected (internal) MAINS derived circuits. In the latter case, transient stresses are variable. Thus, you must know the transient withstand capability of the equipment.
- **Measurement category II** is for measurements performed on circuits directly connected to low voltage installation. Examples are measurements on household appliances, portable tools and similar equipment.
- **Measurement category III** is for measurements performed in the building installation. Examples are measurements on distribution boards, circuit-breakers, wiring (including cables, bus-bars, junction boxes, switches and socket-outlets) in the fixed installation, and equipment for industrial use and some other equipment. For example, stationary motors with permanent connection to a fixed installation.
- **Measurement category IV** is for measurements performed at the source of a low-voltage installation. Examples are electricity meters and measurements on primary overcurrent protection devices and ripple control units.

1.4 Ventilation Requirement

This instrument uses a fan to force cooling. Please make sure that the air inlet and outlet areas are free from obstructions and have free air. When using the instrument in a bench-top or rack setting, provide at least 10 cm clearance beside, above and behind the instrument for adequate ventilation.



CAUTION

Inadequate ventilation may cause an increase of temperature in the instrument, which would cause damage to the instrument. So please keep the instrument well ventilated and inspect the air outlet and the fan regularly.

1.5 Working Environment

Temperature

Operating: 0°C to +40°C

Non-operating: -20°C to +60°C

Humidity

- **Operating:**
0°C to +40°C: ≤80% RH (without condensation)

- **Non-operating:**
-20°C to +40°C: ≤90% RH (without condensation)
Below +60°C: ≤80% RH (without condensation)



WARNING

To avoid short circuit inside the instrument or electric shock, never operate the instrument in a humid environment.

Altitude

- **Operating:** below 3 km
- **Non-operating:** below 12 km

Protection Level Against Electric Shock

ESD ±8kV

Installation (Overvoltage) Category

This product is powered by mains conforming to installation (overvoltage) category II.



WARNING

Ensure that no overvoltage (such as that caused by a bolt of lightning) can reach the product. Otherwise, the operator might be exposed to the danger of an electric shock.

Installation (Overvoltage) Category Definitions

Installation (overvoltage) category I refers to signal level which is applicable to equipment measurement terminals connected to the source circuit. Among these terminals, precautions are done to limit the transient voltage to a low level.

Installation (overvoltage) category II refers to the local power distribution level which is applicable to equipment connected to the AC line (AC power).

Pollution Degree

Pollution Degree 2

Pollution Degree Definition

- **Pollution Degree 1:** No pollution or only dry, nonconductive pollution occurs. The pollution has no effect. For example, a clean room or air-conditioned office environment.
- **Pollution Degree 2:** Normally only nonconductive pollution occurs. Temporary conductivity caused by condensation is to be expected. For example, indoor environment.

- **Pollution Degree 3:** Conductive pollution or dry nonconductive pollution that becomes conductive due to condensation occurs. For example, sheltered outdoor environment.
- **Pollution Degree 4:** The pollution generates persistent conductivity caused by conductive dust, rain, or snow. For example, outdoor areas.

Safety Class

Class 1 – Grounded Product

1.6 Care and Cleaning

Care

Do not store or leave the instrument where it may be exposed to direct sunlight for long periods of time.

Cleaning

Clean the instrument regularly according to its operating conditions.

1. Disconnect the instrument from all power sources.
2. Clean the external surfaces of the instrument with a soft cloth dampened with mild detergent or water. Avoid having any water or other objects into the chassis via the heat dissipation hole. When cleaning the LCD, take care to avoid scarifying it.

CAUTION

To avoid damage to the instrument, do not expose it to caustic liquids.



WARNING

To avoid short-circuit resulting from moisture or personal injuries, ensure that the instrument is completely dry before connecting it to the power supply.



1.7 Environmental Considerations

The following symbol indicates that this product complies with the WEEE Directive 2012/19/EU.



The equipment may contain substances that could be harmful to the environment or human health. To avoid the release of such substances into the environment and avoid harm to human health, we recommend you to recycle this product

appropriately to ensure that most materials are reused or recycled properly. Please contact your local authorities for disposal or recycling information.

You can click on the following link <https://www.rigol.com/intl/services/environmental-protection-statement.html> to download the latest version of the RoHS&WEEE certification file.

2 Product Features

Product Features

- 2/4 channel models, 2/4-channel differential outputs or 4/8-channel single-ended outputs supported
- Full-channel isolation, clean signal without distortion
- Max. sample rate: 2.5 GSa/s
- Support 1 GHz bandwidth differential signal output and ± 10 V high-voltage differential signal output
- Vertical resolution: 16 bits
- A maximum Arb waveform length of 256 Mpts/CH (512 Mpts/CH optional)
- Built-in high-order harmonic generator (max. 20th order)
- Standard: Sequence, PRBS, Multi-pulse, Multi-tone, Pattern, IQ, and Advanced Arb
- 10.1" color touch screen, allowing you to configure and view the waveform parameters at the same time
- Standard Web Control function for easier remote cooperation
- Built-in Arb waveform editing function or PC software Ultra Station to generate Arb waveforms

With up to 2.5 GSa/s sample rate and 256 Mpts/CH memory depth (512 Mpts/CH optional), the DG6000 Series Function/Arbitrary Waveform Generator is an all-in-one generator that integrates Function Generator, Arbitrary Waveform Generator, Noise Generator, Pulse Generator, Harmonics Generator, and Analog/Digital Modulator. It is a multi-functional and cost-effective function/arbitrary waveform generator.

3 Document Overview

This manual gives you a quick overview of the front and rear panels, user interface as well as basic operation methods of the DG6000 series.



TIP

For the latest version of this manual, download it from RIGOL official website (www.rigol.com).

Publication Number

UGB19101-1110

Software Version

00.01.02

Software upgrade might change or add product features. Please acquire the latest version of the manual from RIGOL website or contact RIGOL to upgrade the software.

Format Conventions in this Manual

1. Key

The front panel key is denoted by the menu key icon. For example,  indicates the "Default" key.

2. Menu

The menu item is denoted by the format of "Menu Name (Bold) + Character Shading" in the manual. For example, **Setup**.

3. Operation Procedures

The next step of the operation is denoted by ">" in the manual. For example, .

> **Utility** indicates first clicking or tapping  and then clicking or tapping **Utility**.

Content Conventions in this Manual

The DG6000 series Function/Arbitrary Waveform Generator includes the following models. Unless otherwise specified, this manual takes DG6104 as an example to illustrate the basic operation methods of the DG6000 series.

Model	No. of Channels	Sample Rate	Max. Output Frequency
DG6052	2	2.5 GSa/s	500 MHz
DG6054	4	2.5 GSa/s	500 MHz

Model	No. of Channels	Sample Rate	Max. Output Frequency
DG6102	2	2.5 GSa/s	1 GHz
DG6104	4	2.5 GSa/s	1 GHz

4 Quick Start

4.1 General Inspection

1. Inspect the packaging

If the packaging has been damaged, do not dispose the damaged packaging or cushioning materials until the shipment has been checked for completeness and has passed both electrical and mechanical tests.

The consigner or carrier shall be liable for the damage to the instrument resulting from shipment. RIGOL would not be responsible for free maintenance/rework or replacement of the instrument.

2. Inspect the instrument

In case of any mechanical damage, missing parts, or failure in passing the electrical and mechanical tests, contact your RIGOL sales representative.

3. Check the accessories

Please check the accessories according to the packing lists. If the accessories are damaged or incomplete, please contact your RIGOL sales representative.

Recommended Calibration Interval

RIGOL suggests that the instrument should be calibrated every 12 months.

4.2 Appearance



Figure 4.1 Front Panel



Figure 4.2 Rear Panel

4.3 Dimensions

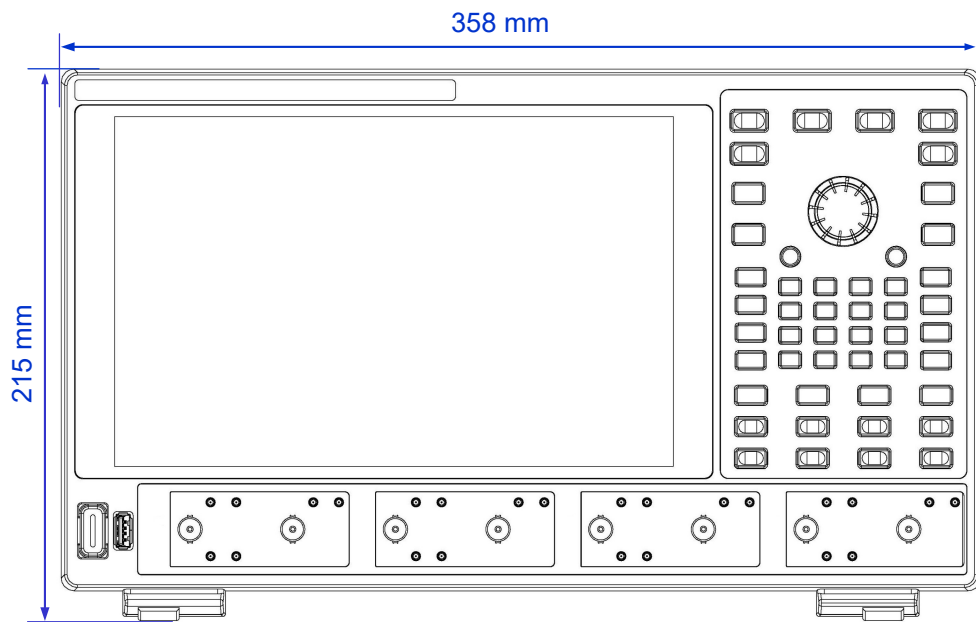

Figure 4.3 Front View

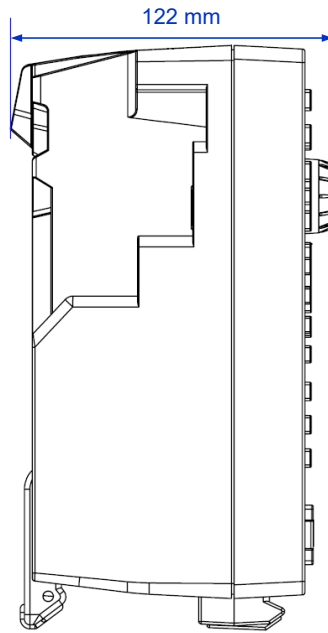

Figure 4.4 Side View

4.4 Product Overview

This chapter introduces the appearance and dimensions, front and rear panels as well as the user interface (display) of the DG6000 series.

4.4.1 Front Panel Overview

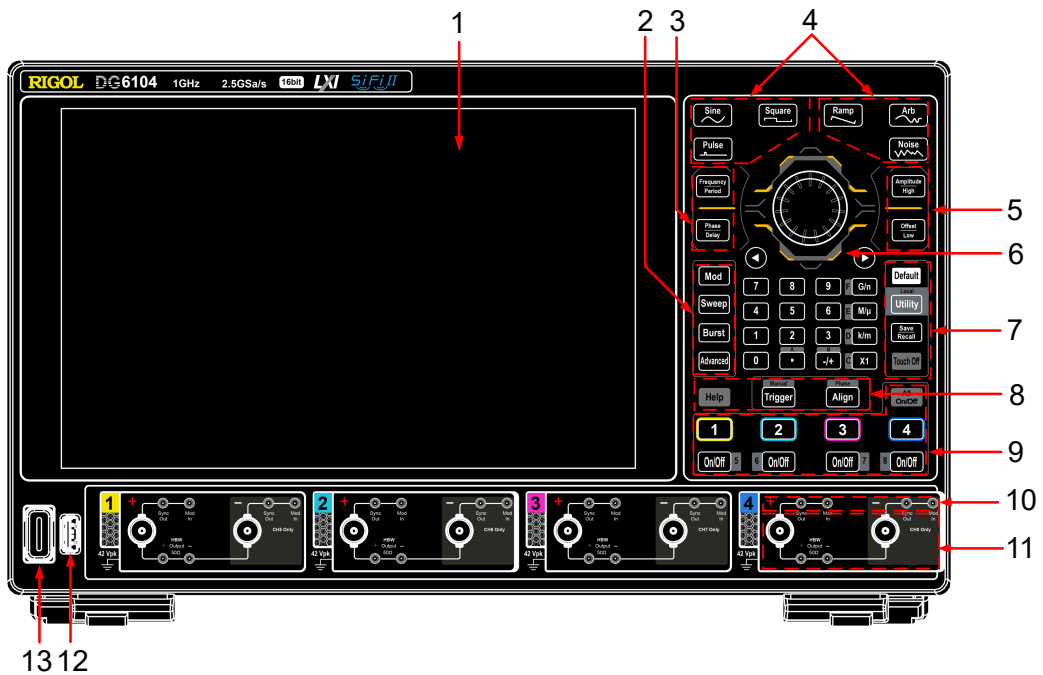

Figure 4.5 Front Panel (4-channel)

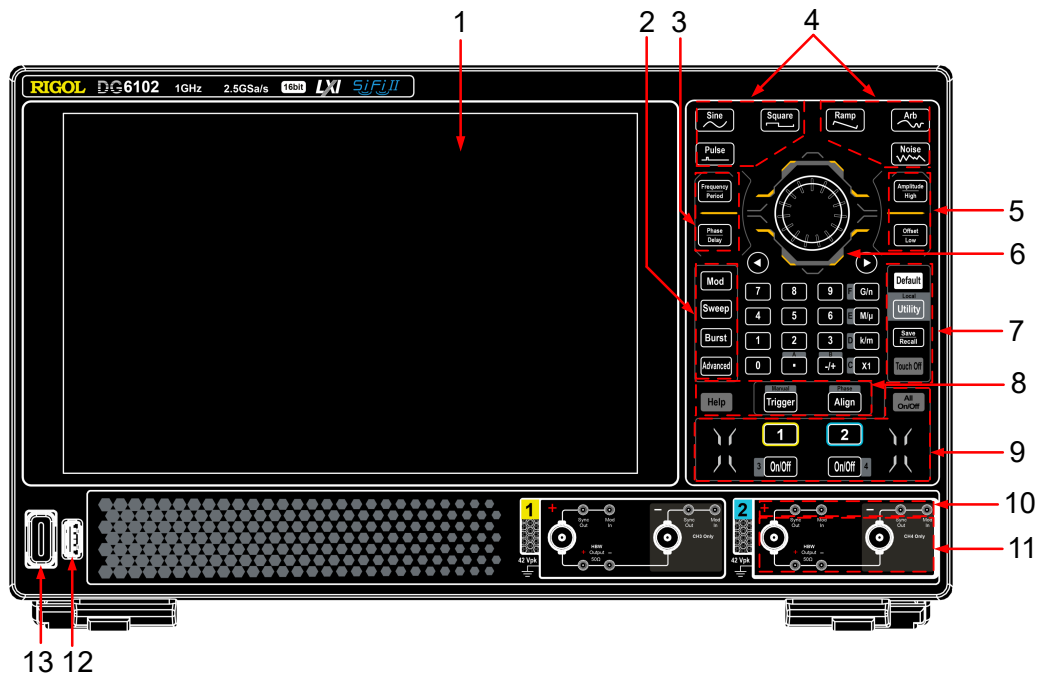

Figure 4.6 Front Panel (2-channel)

1. 10.1-inch Touch Screen

Displays the menu labels, parameter settings, system state, prompt messages, and other information.

2. Output Mode Selection Area

- **Mod**: Modulation key. Press the key to set the output mode to Modulation or Continuous for the current channel. For details about the Modulation mode, please refer to *Modulation*.
- **Sweep**: Sweep key. Press the key to set the output mode to Sweep or Continuous for the current channel. For details about the Sweep mode, please refer to *Sweep*.
- **Burst**: Burst key. Press the key to set the output mode to Burst or Continuous for the current channel. For details about the Burst mode, please refer to *Burst*.
- **Advanced**: Advanced mode key. Press the key to set the output mode to Advanced or Continuous for the current channel. For details about Advanced mode, please refer to *Advanced Mode*.







3. Frequency/Period and Phase/Delay Keys

- **Frequency/Period**: Frequency/Period key. If the focus cursor is not in the **Freq/Period** input field, press the key to move the focus to the **Freq/Period** input field in the Basic Waveform Setting Interface. If the focus cursor is in the **Freq/Period** input field, press the key to switch the input parameter to Frequency or Period. There is no



response when the output mode is set to Sweep or Advanced, the selected basic waveform does not have frequency/period properties, or the focus cursor is on the Channel Setup Interface.

- : Phase/Delay key. In non-Burst mode, press the key to switch the focus cursor to the **Phase** input field in the Basic Waveform Setting Interface. In Burst mode, press the key to switch the focus cursor to the **Phase** or **Delay** input field in the Burst Setting Interface. There is no response when the output mode is set to Sweep or Advanced, the selected basic waveform or the burst sub-mode does not have phase/delay properties.

4. Basic Waveform Selection Area

- : Sine key. Press the key to set the basic waveform to Sine for the current channel. For details about the Sine waveform, please refer to *To Output Sine Wave*.
- : Square key. Press the key to set the basic waveform to Square for the current channel. For details about the Square waveform, please refer to *To Output Square Wave*.
- : Pulse key. Press the key to set the basic waveform to Pulse for the current channel. For details about the Pulse waveform, please refer to *To Output Pulse*.
- : Ramp key. Press the key to set the basic waveform to Ramp for the current channel. For details about the Ramp waveform, please refer to *To Output Ramp Wave*.
- : Arb key. Press the key to set the basic waveform to Arb for the current channel. For details about Arb, please refer to *To Output Arbitrary Waveforms*.
- : Noise key. Press the key to set the basic waveform to Noise for the current channel. For details about the Noise, please refer to *To Output Noise*.

5. Amplitude Range/High Level and Offset/Low Level Keys





- : Amplitude Range/High Level key. When the output type is set to differential, if the focus cursor is not in the **DM Ampl** input field, press the key to move the focus to the **DM Ampl** input field. When the output type is set to single-ended, if the focus cursor is not in the **Ampl/HighL** input field, press the key to move the focus to the **Ampl/HighL** input field. If the focus cursor is in the **Ampl/HighL** input field, press the key to switch the input parameter to Amplitude Range or High Level. There is no response when the cursor is in the Channel Setup Interface.
- : Offset/Low Level key. When the output type is set to differential, if the focus cursor is not in the **CM Offset** input field, press the key to move the focus

to the **CM Offset** input field. When the output type is set to single-ended, if the focus cursor is not in the **Offset/LowL** input field, press the key to move the focus to the **Offset/LowL** input field. If the focus cursor is in the **Offset/LowL** input field, press the key to switch the input parameter to Offset or Low Level. There is no response when the cursor is in the Channel Setup Interface.



6. Parameter Input Area

The parameter input area comprises a knob, arrow keys, and a keyboard. For how to set the parameter using the parameter input area, please refer to *To Set Parameters with the Front-panel Keys and Knobs*.

7. Quick Operation Key

- : Default key. Press the key and a dialog box is displayed. Click or tap **OK** or press the key twice to restore the instrument to its factory defaults.
- : Utility/Local key. When the instrument is in local mode, press the key to open/close the Utility menu. When the instrument is in remote control mode, you can press this key to restore the instrument to local operation from remote control.
- : Save/Recall key. Press the key to open or close the Store menu.
- : Touch Off key. Press the key to disable or enable the touch screen function.



8. Help Key, Manual Trigger Key, Align Phase Key

- : Help key. Press the key to open or close the "Help" menu. In this menu, you can get its help information by clicking or tapping the link for the desired item.
- : manual trigger key. When the trigger source is set to manual, the key backlight will be on. At this time, a manually triggered output is generated each time you press the key.
- : align phase key. Press the key to align phase. For details, refer to *Align Phase*.

9. Channel Output Control Area

: all channel on/off key. Press this key to turn on/off the outputs of all channels simultaneously.

2-channel model (DG6052/DG6102):

-  / : channel selection key. When the output type is set to differential, press the key to select a specified channel as the current channel. You can set the waveform parameters for the channel with the front-panel keys and knobs.

When a channel is selected, the backlight of the corresponding key is illuminated. When the output type is set to single-ended, the instrument switches to 4-channel single-ended output, and the channel selection key is reused as the channel on/off key for CH1/CH2. When CH1/CH2 is selected, press **1** / **2** again to turn on/off the output of CH1/CH2.

- **3 On/Off** / **On/Off 4**: channel on/off key. When the output type is set to differential, press the channel on/off key below the channel selection key to enable or disable the corresponding channel output. When the channel output is enabled, the backlight of the corresponding key is illuminated. When the output type is set to single-ended, the instrument switches to 4-channel single-ended output, and the channel on/off key serves as the channel selection key and channel on/off key for CH3/CH4. Press **3 On/Off** / **On/Off 4** to select the specified channel as the current channel. When CH3/CH4 is selected, press **3 On/Off** / **On/Off 4** again to turn on/off the output of CH3/CH4.

4-channel model (DG6054/DG6104):

- **1** / **2** / **3** / **4**: channel selection key. When the output type is set to differential, press the key to select a specified channel as the current channel. You can set the waveform parameters for the channel with the front-panel keys and knobs. When a channel is selected, the backlight of the corresponding key is illuminated. When the output type is set to single-ended, the instrument switches to 8-channel single-ended output, and the channel selection key is reused as the channel on/off key for CH1/CH2/CH3/CH4. When CH1/CH2/CH3/CH4 is selected, press **1** / **2** / **3** / **4** again to turn on/off the output of CH1/CH2/CH3/CH4.
- **On/Off 5** / **6 On/Off** / **On/Off 7** / **8 On/Off**: channel on/off key. When the output type is set to differential, press the channel on/off key below the channel selection key to enable or disable the corresponding channel output. When the channel output is enabled, the backlight of the corresponding key is illuminated. When the output type is set to single-ended, the instrument switches to 8-channel single-ended output, and the channel on/off key serves as the channel selection key and channel on/off key for CH5/CH6/CH7/CH8. Press **On/Off 5** / **6 On/Off** / **On/Off 7** / **8 On/Off** to select the specified channel as the current channel. When CH5/CH6/CH7/CH8 is selected, press **On/Off 5** / **6 On/Off** / **On/Off 7** / **8 On/Off** again to turn on/off the output of CH5/CH6/CH7/CH8.

10. Sync Output/Trigger Output Connector, Modulation Input Connector

DG6052/DG6102: four pairs

DG6054/DG6104: eight pairs

- Sync output/trigger output (Sync Out) connector: SMB connector. When the sync output of specified channel is enabled, this connector is used to output the sync signal of corresponding channel. When the trigger output is enabled, this connector is used to output the trigger signal of the corresponding channel. The sync output and the trigger output cannot be enabled at the same time.
- Modulation input (Mod In) connector: SMB connector. When the output mode is set to Modulation for Channel and an external modulation source is selected with the modulation port set to the front port, this connector accepts an external modulation signal.

11. Output Connectors

DG6000 supports both single-ended and differential outputs (HBW/AMP). Different output modes use different connectors.



- : BNC type connector with 50 Ω nominal output impedance. In single-ended output mode, each channel can output two-channel single-ended signals. In AMP differential output type, the two terminals of each channel can be used to output differential signals (left "+" and right "-").

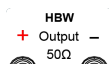

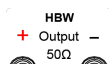
- : SMB type connector with 50 Ω nominal output impedance. In HBW differential output type, they are used to output the differential signal (left "+" and right "-").



CAUTION

To ensure output performance, please perform load termination at the user device end when the output type is HBW.

12. USB HOST Interface

Reads the waveform or state files stored in USB; saves the current instrument state or the edited waveform data into USB; or saves the content displayed on the screen to the USB in the format of a captured image. FAT32, NTFS, and exFAT formats are supported.

13. Power Key

Powers the signal generator on or off.

4.4.2 Rear Panel Overview

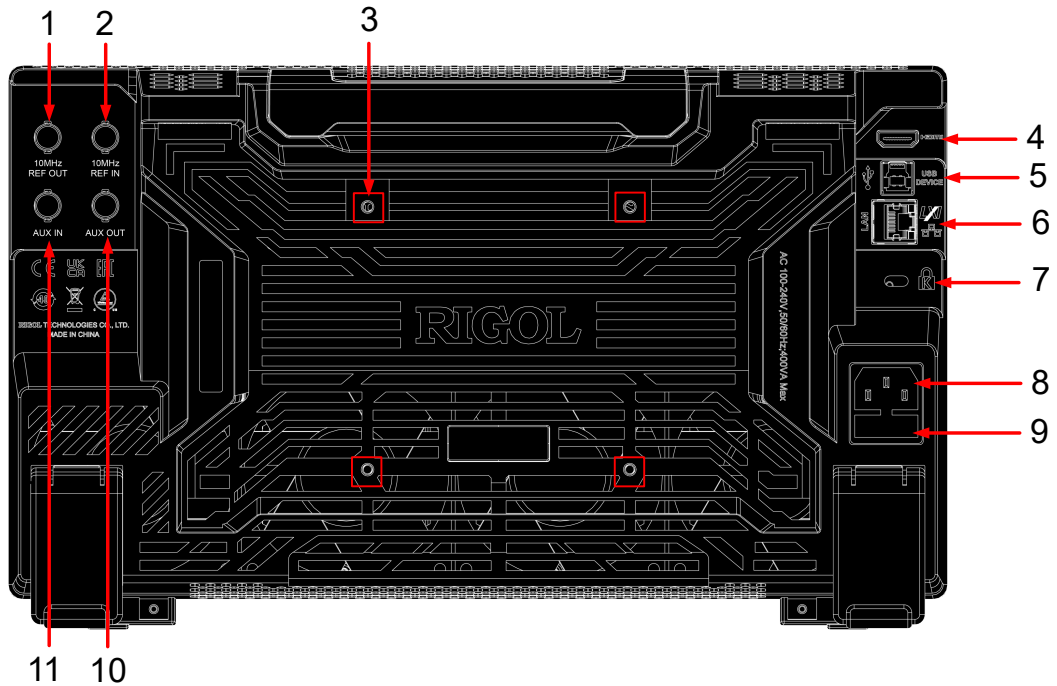

Figure 4.7 Rear Panel

1. 10 MHz REF OUT

BNC type connector, can output a 10 MHz clock signal generated by the instrument's internal crystal oscillator.

2. 10 MHz REF IN

BNC type connector. When external clock source is selected, this connector accepts an external clock signal.

3. Mounting Screw Holes

Interval of screw holes: 100 mm x 100 mm. Use screws (M4*6-10) to secure the instrument to the bracket with the same screw hole interval.

4. HDMI

You can connect the instrument to an external display that has the HDMI port (e.g. monitor or projector) via this interface to have a clear view of the instrument's display. Meanwhile, you can still operate on the instrument's touch screen.

5. USB DEVICE

Connect the instrument to the PC via this interface. Then you can use the PC software to send SCPI commands or use the user-defined programming to control the instrument.

6. LAN

Connects the instrument to network. The instrument conforms to LXI CORE 2011 DEVICE instrument standard. Its test system can be built quickly. Then you can control the instrument by using the Web Control, sending SCPI commands via PC software, or using the user-defined programming.

7. Security Lock Hole

Use a standard PC/laptop lock cable to secure the instrument to a work bench or other location.

8. AC Power Connector

The AC power requirements of the instrument are 100 V to 240 V, 50 Hz/60 Hz. Please use the power cord provided in the accessories to connect the instrument to the AC power source.

9. Fuse

If you need to replace the fuse, use only the specified fuse.

10. AUX OUT (not used)

It is used for synchronization of multiple instruments.

11. AUX IN

BNC type connector. Its function is determined by the current work mode of the channel.

- **Trigger input:** When the channel output mode is set to Sweep, Burst, Sequence, or Multi-pulse and the trigger source is set to External, this connector accepts an external TTL-compatible pulse signal as the trigger input signal.
- **Digital modulation input:** When the channel output is set to ASK/FSK/PSK modulation, the modulation source is set to External, and the modulation port is set to rear port, this connector accepts an external signal as the modulation source.

4.4.3 2-Channel Model User Interface Overview

The 2-channel models of this series support single-channel mode, 2-channel mode, 4-channel mode (single-ended), and auto mode (automatically selecting the display mode based on the number of enabled channels). You can select your desired interface layout based on actual requirements. The user interface in each display mode displays the information for the corresponding number of channels. You can click or tap the **Windows** key at the lower-right of the interface to select different display modes.

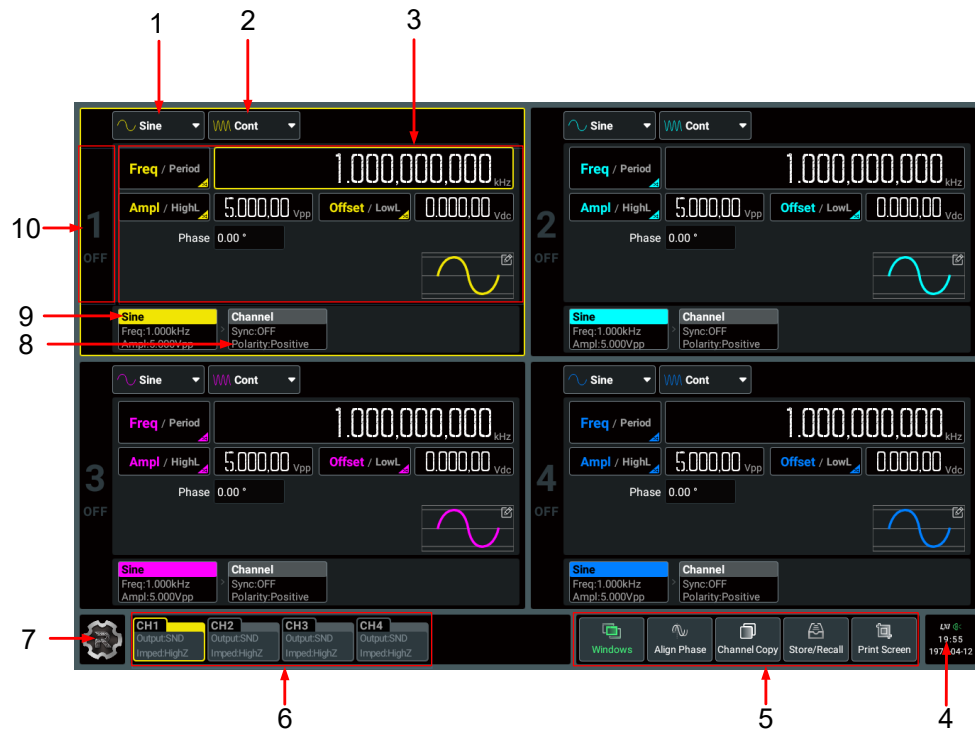

Figure 4.8 2-Channel Model User Interface - 4-Channel Display Mode (Single-ended)

1. Basic Waveform Drop-down Button

Click or tap the drop-down button to select the waveform type for the specified channel. Available waveform types are related to the current output mode. Note that when the output mode is set to "Advanced", basic waveforms are not available.

2. Output Mode Drop-down Button



Click or tap the drop-down button to set the output mode to Continuous, Modulation, Sweep, Burst, or Advanced for the specified channel.



3. Parameter Configuration Area

You can set the waveform parameters and channel parameters for the corresponding channel in this area.

4. Notification Area

Displays the USB icon, LAN icon, sound icon, and remote control icon. You can click or tap this area to open the "Utility" menu.

- USB storage device icon: When a USB storage device is detected,  will be displayed.
- LAN icon: When the LAN interface is successfully connected,  is displayed.

- Sound icon: In the "Utility" menu, click or tap **Setup** > **Beeper** to enable or disable the sound. When on,  will be displayed; when off,  will be displayed.
- Remote control icon: When the instrument is in remote control mode,  will be displayed.
- Date and Time: When the "Show Time" is set to On, the system date and time will be displayed.

5. Function Keys

- Windows key: Click or tap the key to set the display mode to auto mode, single-channel display mode, 2-channel display mode, or 4-channel display mode (single-ended).
- Align Phase key: Click or tap the key to perform the phase alignment operation. For details, please refer to [Align Phase](#).
- Channel Copy key: Click or tap this key to open the channel copy menu. You can copy all states and waveforms of one channel to the other one. For details, please refer to [Channel Copy](#).
- Store/Recall key: Click or tap the key to open/close the storage menu.
- Print Screen key: Click or tap this key to capture the current screen and save the picture to internal memory.

6. Channel Labels

For 2-channel models, when the output type is differential (HBW/AMP), it displays 2 channel labels; when the output type is single-ended, it displays 4 channel labels. The channel labels display the channel on/off state ("CH1", "CH2"..." illuminated or not), the selected channel (the label highlighted or not), the output type (SND/HBW/AMP), and the impedance settings. You can click or tap the label to select the specified channel. Drag the channel label up to enable the output of the corresponding channel or drag the label down to disable the output of the corresponding channel.

7. Function Navigation Icon

Click or tap the icon to open the function navigation menu in which you can access the specified function menu by clicking or tapping the corresponding function key (Utility, Preset, Help, Bundle By Source, Arb Build, Output Type, Shut Down).

8. Channel Tab

Displays the sync on/off status and polarity for the corresponding channel. You can click or tap this tab to switch to the channel setup interface.

9. Waveform Tab

Displays the selected continuous waveform type, frequency, and amplitude range. You can click or tap this tab to switch to the waveform parameter setting interface.

10. Channel Identifier

Identifies the channel number and indicates the on/off state of the channel. You can simply click or tap the area to enable or disable the corresponding channel output.

4.4.4 4-Channel Model User Interface Overview

The 4-channel models of this series support auto mode, single-channel mode, 2-channel mode, 4-channel mode, and 8-channel mode (single-ended). You can select your desired interface layout based on actual requirements.

Auto Display Mode

Selects the display mode automatically based on the number of enabled channels.

Single-Channel Display Mode

In single-channel display mode, the interface displays the waveform parameter setting interface and the channel parameter setting interface of one channel. You can click or tap the channel label at the bottom of the interface to select the channel to display. It allows for easier viewing and quick setup of the target channel.

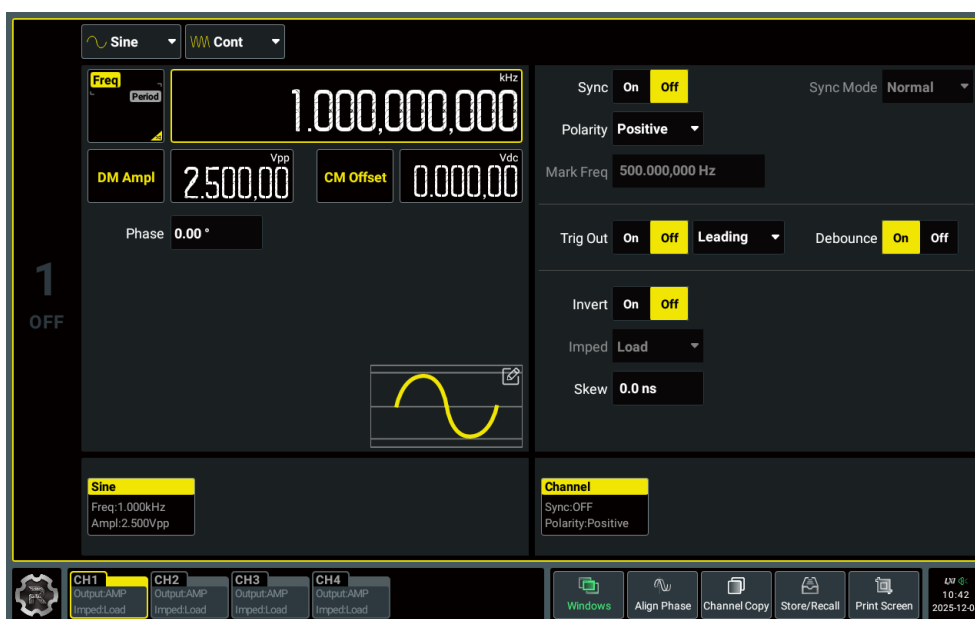

Figure 4.9 4-Channel Model User Interface - Single-Channel Display Mode

2-Channel Display Mode

In 2-channel display mode, the interface only displays the information of two channels. You can click or tap the channel label at the bottom of the interface to select the channel to display. The simple and intuitive interface layout is ideal for

application scenarios where an individual channel requires attention. It allows for easier viewing and quick setup of the target channel.



Figure 4.10 4-Channel Model User Interface - 2-Channel Display Mode

4-Channel Display Mode

In 4-channel display mode, the interface displays the information of four channels at the same time. You can click or tap the channel label at the bottom of the interface to select the channel to display. This mode offers a balanced display layout to meet the requirements of medium-scale multi-channel testing. It enables simultaneous monitoring and quick setup of multiple channels.



Figure 4.11 4-Channel Model User Interface - 4-Channel Display Mode

8-Channel Display Mode (Single-ended)

For 4-channel models, 8-channel display mode is supported only in single-ended

output type. You can click or tap  > **Output Type** > **SND** to select single-ended output type. After the 8-channel display mode is selected, the interface displays the main information of eight channels (*Figure 4.12*). The displayed information is related to the current output waveform. This mode is ideal for use in scenarios requiring comprehensive monitoring of channel output parameters, such as multi-channel collaborative testing in complex systems.

Some parameters are not displayed on the main interface in 8-channel display mode. If you need to view or set the complete parameters related to a channel, you can click

or tap  on the specified channel configuration area to open the parameter setting interface (*Figure 4.13*). In 8-channel display mode parameter setting interface, click or tap the channel list on the left or the channel label at the bottom to select different channels for viewing and editing. After editing, click or tap **Back** at the bottom-right of the interface to quit the parameter setting interface.

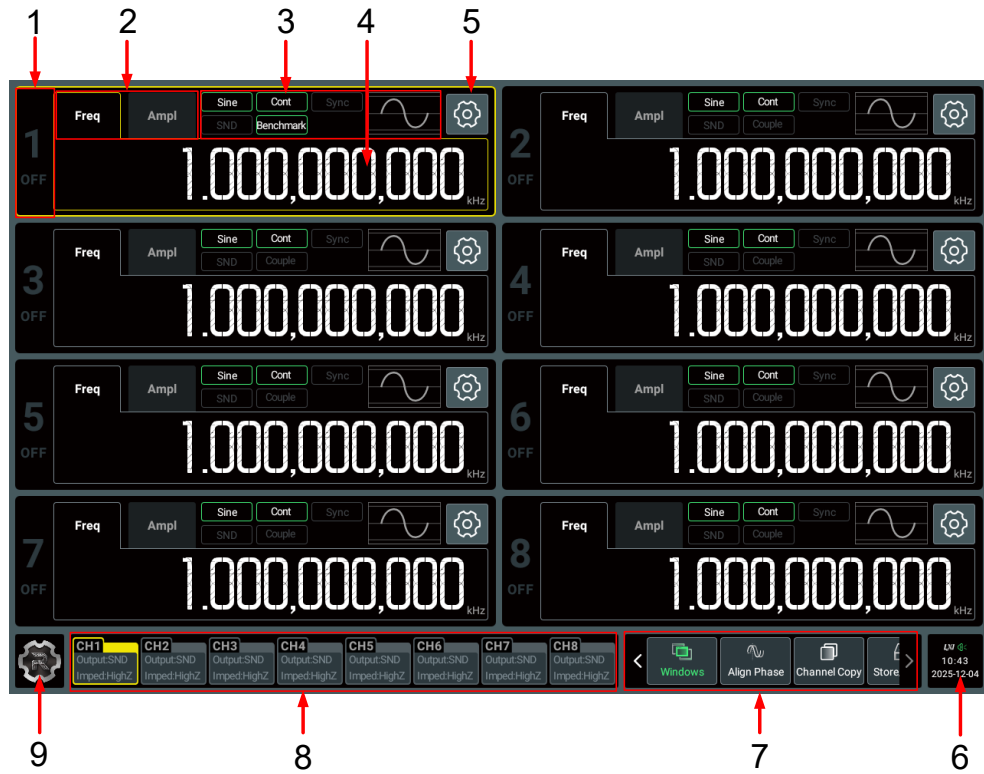

Figure 4.12 4-Channel Model User Interface - 8-Channel Display Mode (Single-ended)

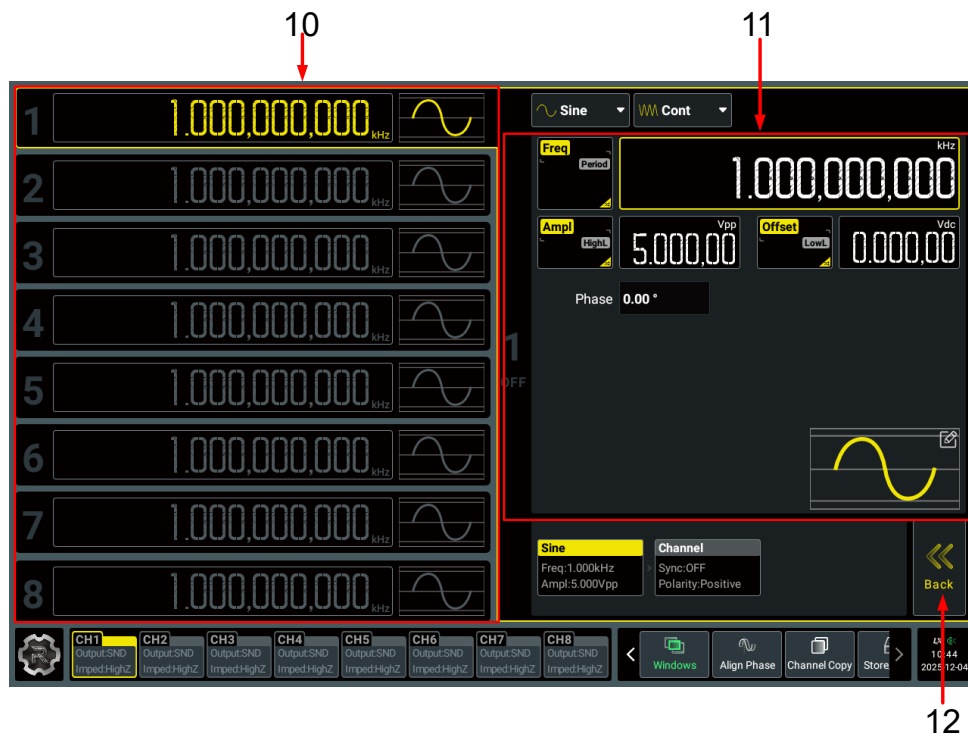

Figure 4.13 8-Channel Display Mode Parameter Setting Interface

1. Channel Identifier

Identifies the channel number and indicates the on/off state of the channel. You can simply click or tap the area to enable or disable the corresponding channel output.

2. Waveform Parameter Selection Keys

Click or tap the parameter selection key to select the waveform parameter to display for the specified channel. Available waveform parameters are related to the current output waveform.

3. Channel Parameter and Waveform Thumbnail Display Area

Displays the selected basic waveform, output mode, sync state and polarity, output type, Coupling state, Track state, and trigger source (only when the current mode supports triggering).

4. Waveform Parameter Display/Setting Area





Displays the specific value of the selected waveform parameter. Click or tap this area to set this parameter.

5. Parameter Setting Key

Click or tap this key to open the parameter configuration interface for the specified channel, as shown in *Figure 4.13*. The parameter configuration interface is displayed at the right side of the screen. You can set the waveform parameters and channel parameters for the corresponding channel in this area. Click or tap **Back** to quit the mode.

6. Notification Area

Displays the USB icon, LAN icon, sound icon, and remote control icon. You can click or tap this area to open the "Utility" menu.

- USB storage device icon: When a USB storage device is detected,  will be displayed.
- LAN icon: When the LAN interface is successfully connected,  is displayed.
- Sound icon: In the "Utility" menu, click or tap **Setup > Beeper** to enable or disable the sound. When on,  will be displayed; when off,  will be displayed.
- Remote control icon: When the instrument is in remote control mode,  will be displayed.
- Date and Time: When the "Show Time" is set to On, the system date and time will be displayed.

7. Function Keys

Windows, Align Phase, Channel Copy, Store/Recall, Print Screen functions keys are available.

8. Channel Labels

For 4-channel models, when the output type is differential (HBW/AMP), it displays 4 channel labels; when the output type is single-ended, it displays 8 channel labels. The channel labels display the channel on/off state ("CH1", "CH2"... illuminated or not), the selected channel (the label highlighted or not), the output type (SND/HBW/AMP), and the impedance settings. You can click or tap the label to select the specified channel. Drag the channel label up to enable the output of the corresponding channel or drag the label down to disable the output of the corresponding channel.

9. Function Navigation Icon

Click or tap the icon to open the function navigation menu in which you can access the specified function menu by clicking or tapping the corresponding function key (Utility, Preset, Help, Bundle By Source, Arb Build, Output Type, Shut Down).

10. Channel List

Displays the brief information of the 8 channels. You can click or tap the specified channel to select the channel and open its parameter configuration interface. The selected channel is highlighted.

11. Parameter Configuration Area

In 8-channel mode, it displays all parameters of the selected channel. You can set the parameters for the specified channel in this area.

12. Back Key

Click or tap the key to close the channel configuration interface and return to the 8-channel display mode.

4.5 To Prepare for Use

4.5.1 To Adjust the Supporting Legs

Adjust the supporting legs properly to use them as stands to tilt the instrument upwards for stable placement of the instrument as well as better operation and observation. You can also fold the supporting legs when the instrument is not in use for easier storage or shipment, as shown in the figure below.

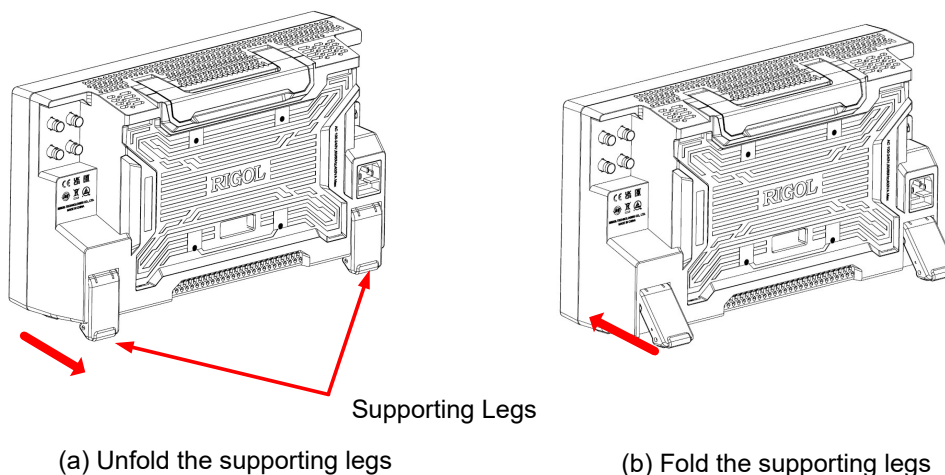

(a) Unfold the supporting legs

(b) Fold the supporting legs

Figure 4.14 Adjust the Supporting Legs

4.5.2 To Connect to Power

The power requirements of this signal source are 100 V to 240 V, 50 Hz/60 Hz. Please use the power cord provided in the accessories to connect the instrument to the AC power source, as shown in the figure below.

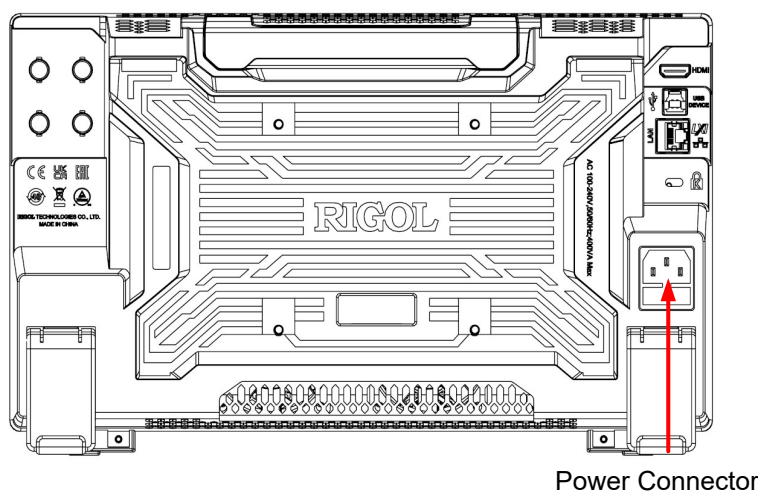

Figure 4.15 Connect to Power



WARNING

To avoid electric shock, please ensure that the instrument is correctly grounded.

4.5.3 Turn-on Checkout





After the instrument is connected to the power source, press **0** at the lower-left corner of the front panel to power on the instrument. During the start-up process, the

instrument performs a series of self-tests. After the self-test, the splash screen is displayed. You can also click or tap  > **Utility** > **Setup** to set the "Power Set" to "Auto". The instrument powers on once connected to power.



TIP

You can shut down the instrument in the following ways.

- Click or tap  > **Shut Down** or press the front-panel  and a dialog box "Do you need to shut down the instrument?" is displayed. Click or tap **Shut Down** to shut down the instrument.
- Press  twice to shut down the instrument.
- Press  for three seconds to shut down the instrument.

4.5.4 To Set the System Language

The instrument supports system languages including Chinese and English. You can click or tap  > **Utility** > **Setup** to enter the basic settings menu. Then click or tap the **Language** drop-down button to set the system language to "Simplified Chinese", "Traditional Chinese", or "English".

4.6 Touch Screen Gestures

The instrument provides a capacitive touch screen, which is convenient for you to operate and make configurations. It features great convenience, high flexibility, and great sensitivity. The actions supported by the touch screen controls include tapping and dragging.

4.6.1 Tap

Use one finger to tap the symbol or characters on the screen slightly, as shown in *Figure 4.16*. With the Tap gesture, you can perform the following operations:

- Tap the menu displayed on the screen to operate on the menu.
- Tap the function navigation icon at the lower-left corner of the touch screen to enable the function navigation.
- Tap the displayed numeric keypad to set the parameters.
- Tap the virtual keypad to set the filename.

- Tap the close button at the upper-right corner of the message box to close the prompt window.
- Tap other windows on the touch screen and operate on the windows.



Figure 4.16 Tap Gesture

4.6.2 Drag

Use one finger to select the object, and then drag the object to a destination place, as shown in [Figure 4.17](#). With the drag gesture, you can perform the following operations:

- Drag the window controls to change the position of the window (e.g. numeric keypad).
- Drag the cursor of the Arb Build function to change the position of the cursor.
- Drag the channel label to enable or disable the channel output.



Figure 4.17 Drag Gesture

4.7 Parameter Setting Method

This instrument allows you to use the front-panel parameter input area and the touch screen to set parameters for the instrument.

**NOTE**

This manual mainly introduces how to set the parameters using the touch screen.

4.7.1 To Set Parameters with the Front-panel Keys and Knobs



You can use the front-panel parameter input area to set some parameters of the instrument. The parameter input area consists of a knob, a numeric keyboard, unit selection keys, and arrow keys, as shown in the figure below.



**Knob**

You can rotate the knob to move the cursor and navigate through the menu items. Then perform the following operations:







- **If the cursor selects a parameter input field**, you can press the knob to enter the parameter editing mode. You can use the arrow keys to move the cursor. When the cursor selects the digit place, rotate the knob to make the value at the cursor +1 (clockwise) or -1 (counter-clockwise). When the cursor selects the unit, rotate the knob to make the parameter overall $\times 10$ (clockwise) or $\div 10$ (counter-clockwise). Press the knob again to confirm the parameter setting and disable the parameter editing mode.
- **If the cursor selects a drop-down button**, you can press the knob to expand the drop-down menu and then rotate the knob to select a parameter in the menu. After that, press the knob again to confirm your selection and collapse the drop-down menu.
- **If the cursor selects a key, on/off switch, or tab control**, pressing the knob is equivalent to tapping the corresponding key, on/off switch, or tab control using the touch screen.

Numeric Keyboard

The numeric keyboard is composed of numeric keys (from 0 to 9), the decimal point, and symbol keys. If the current cursor selects the input field, you can press the numeric key to input a number; press ^A  to input "."; press ^B  to input "-" or "+". When using the numeric keyboard, you can also perform the following operations:













- Press the knob to confirm the input.
- Press  to delete characters.
- Press  to cancel the input.

TIP

When inputting hexadecimal characters, use ^A , ^B , ^C , ^D , ^E , or ^F  to input "A", "B", "C", "D", "E", or "F" respectively.

Unit Selection Keys

When setting a parameter with the numeric keyboard on the front panel, you can use the keys to select the unit of the parameter.



- ^C : sets the parameter unit to the default one. For example, when setting the phase, press  > ^C  to set the phase to 1°; when setting the frequency, press  > ^C  to set the frequency to 1 Hz.
- ^D , ^E , ^F : when setting the frequency/impedance, use the unit (k/M/G) before "/"; when setting the time/amplitude range/offset, use the unit (m/μ/n) after "/". For example, when setting the frequency, press  > ^D  to set the frequency to 1 kHz; when setting the period, press  > ^D  to set the period to 1 ms.

TIP

When the set value exceeds the limit value, the instrument automatically adjusts the parameter to meet the requirements.

Arrow keys

- In normal mode, you can use the keys to move the cursor to select the desired menu item. It is equivalent to rotating the knob.

- In parameter editing mode, you can use the keys to select the digit place to be modified. If the focus cursor is in the leftmost data place of the parameter, press  to left pad the parameter with zeros.
- When inputting parameters using the numeric keyboard,  is used to delete the character while  is used to cancel the input and close the input field.

4.7.2 To Set Parameters with the Touch Screen

For this instrument, you can use the touch screen function to set all of its parameters. Click or tap the parameter input field and a virtual keypad will be displayed. You can use the pop-up keypad to complete your parameter setting. The method of using the virtual keypad is as follows.

Input a String

When naming a file or folder, you need to use the string keypad to input a string.

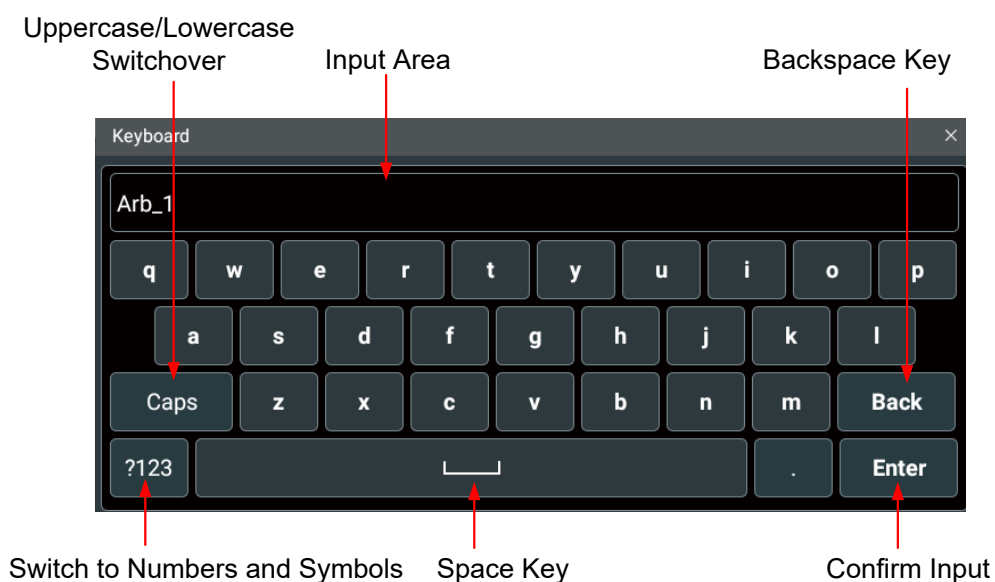

Figure 4.18 String Keypad

1. Clear the name input area

If there is no character in the "Input Area", please go to the next step. If there are characters in the "Input Area", click or tap the "Back" key to delete all the characters from the "Input Area" in order.

2. Input the upper-case letter

If you want to input an upper-case letter, first use the "Caps" key to switch between the upper-case and lower-case modes. If the "Caps" key is selected, input the upper-case letter with the virtual keypad. If not, first click or tap the Caps key

to ensure it is selected, then input the upper-case letter. All the input letters will be displayed in the "Input Area".

3. Input the lower-case letter

Refer to the operation specified in the previous step. If the Caps key is not selected, directly input the lower-case letter.

4. Input numbers or symbols

If the letter keypad is displayed, you need to click or tap the numeric switchover key to switch to the numeric keypad, and input numbers or symbols with the numeric keypad. All the input letters will be displayed in the "Input Area".

5. Delete or modify the unwanted characters that have been input

During the character input process, you can delete or modify the unwanted character if necessary. To delete the characters that have been input, move the cursor to the unwanted character and then click or tap the "Back" key in the virtual keypad. If you want to modify the characters that have been input, delete the unwanted characters first and then input the new characters.

6. Confirm the input

After completing the input operation, click or tap "Enter".

Input a Value

When setting or modifying a function parameter, you can input an appropriate value with the numeric keypad.

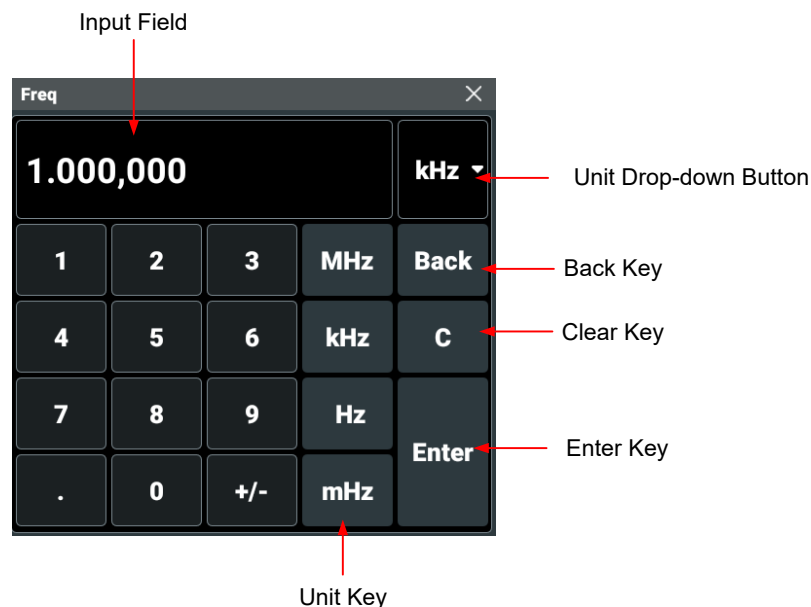

Figure 4.19 Numeric Keypad

Use the numeric keys in the numeric keypad to input a value. Then select the desired unit, and the numeric keypad is turned off automatically. This indicates that you have

completed the parameter setting. The unit drop-down menu includes all available units. You can also click or tap the unit drop-down button to select the desired unit when multiple units are available. Then click or tap "Enter" to confirm input and close the numeric keypad.

4.8 To Replace the Fuse

If you need to replace the fuse, please use the proper fuse (AC 250 V, T5 A; 5.2 mm×20 mm) and follow the steps shown below (see [Figure 4.20](#)).

1. Power off the instrument and remove the power cord.
2. Insert a small straight screwdriver into the slot at the power socket and pry out the fuse holder gently.
3. Remove the fuse.
4. Insert the proper fuse into the fuse holder.
5. Re-insert the fuse holder into the power socket.

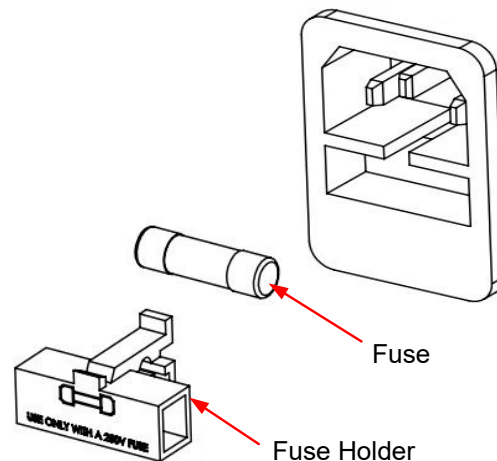

Figure 4.20 Replace the Fuse



WARNING

To avoid electric shock, please make sure that the instrument is powered off and disconnected from the power before replacing the fuse. Also, please make sure the fuse is consistent with the required fuse rating.

4.9 To Use the Security Lock

If necessary, you can lock the instrument to a fixed location by using a standard laptop security lock (please purchase it by yourself), as shown in the figure below.

The method is as follows: align the lock with the lock hole and plug it into the lock hole vertically, turn the key clockwise to lock the instrument, and then pull the key out.

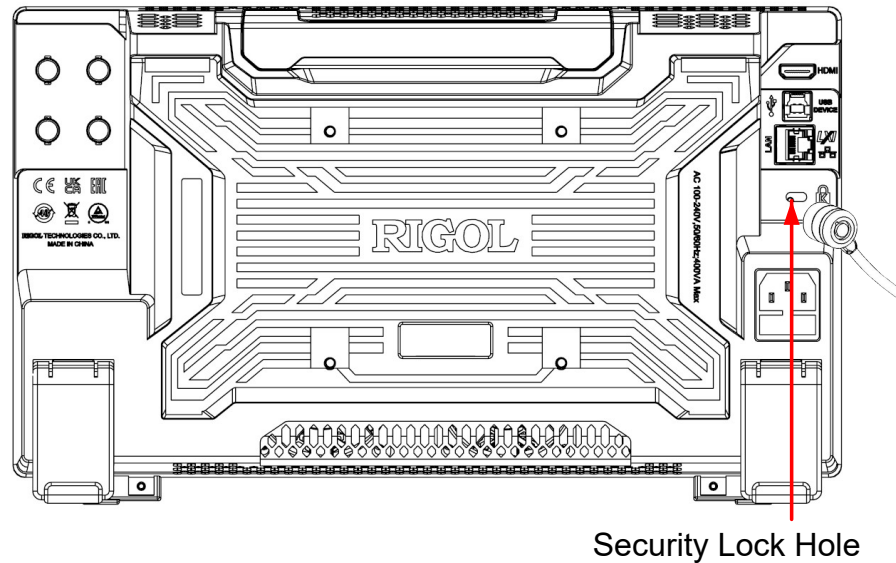



Figure 4.21 Use the Security Lock



CAUTION

Please do not insert other objects into the security lock hole to avoid damaging the instrument.

4.10 To Use the Built-in Help System

The built-in help file provides information about the functions and menu introductions of the instrument. Click or tap  > **Help** to enter the help system.

In the help system, you can get its help information by clicking on or tapping the link for the specified chapter.

4.11 To View the Option Information and the Option Installation

DG6000 provides performance and function upgrade options to fulfill your requirements. If you need any of these options, please order them according to the Order No. available in *Appendix A: Options and Accessories*, and then install the options by referring to this section. Besides, you can also view all options of the instrument or activate the newly purchased option.

View Options

Click or tap the navigation icon  > **Utility** to enter the Utility menu. Click or tap **Options** to view the option installation information.

Install Options

The option license is a string of fixed characters. The option file should be in specific format, with the file extension ".lic". After you purchase an option, you will obtain a key (used for obtaining desired the option license). Then, you can install the option according to the following steps.

1. Obtain an Option License

- a. Log in to the RIGOL official website (<http://www.rigol.com>), click **SERVICE CENTRE** > **License Activation** to enter the software license registration;
- b. In the software license registration interface, input the correct key, serial number (click or tap  > **Utility** > **About** to obtain the serial number of the instrument), and verification code. Then click **Generate** to obtain the option license. If you need to use the file, please download it to the USB storage device.

2. Install Options

You can install the option in the following ways:

- Open the file (*.lic) to obtain the license. Use the :SYSTem:LIcense:INSTall <License> command to install the option.
- Save the license file to the USB storage device and connect the USB correctly to the instrument (you can also save the file to the C disk). Then use the SYSTem:LIcense:INSTall:UDISk <path> command to install the option.
- Save the license file to the USB storage device, connect the USB correctly to the instrument (you can also save the file to the C disk). Then click or tap **Store/Recall** to open the "Store" menu. Select the license file and then click or tap **Option** to install the option.

After installation, a prompt message "Option activated successfully" is displayed.

TIP

- For SCPI commands, please refer to *DG6000 Programming Guide*.
- During the installation process, you are not allowed to power off the instrument.
- You are not allowed to modify the license filename.



5 Continuous

Click or tap the "Output Mode" drop-down button to select "Cont" and configure the channel to output continuous waveform. The Continuous setting interface is as shown in the figure below. You can click or tap one of the tabs at the bottom to access the Continuous Setting Interface or Channel Setup Interface. For Channel Setup Interface, please refer to *Channel Setup*. This chapter only describes the Continuous settings.

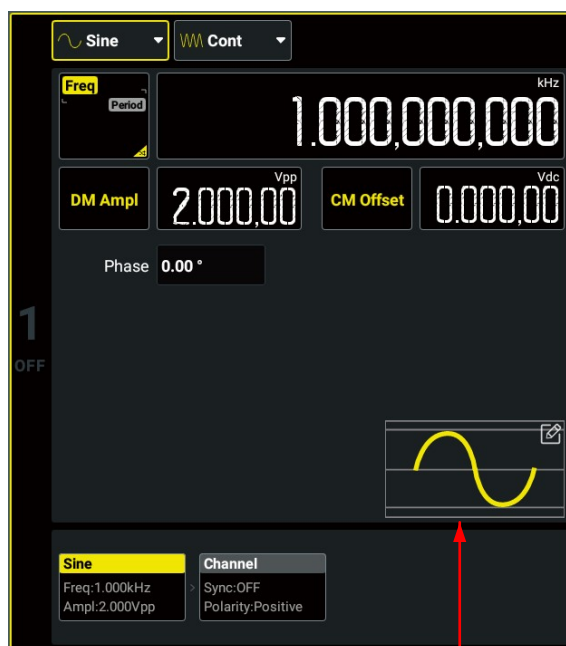

Waveform Preview/Selection

Figure 5.1 Continuous Setting Interface

The following tables show the ranges of the continuous waveform (except DC and noise) frequency respectively.

Table 5.1 Range of Continuous Waveform Frequency

Waveform	DG6052/DG6054	DG6102/DG6104
Sine	SND/AMP: 1 μ Hz to 350 MHz HBW: 1 μ Hz to 500 MHz	SND/AMP: 1 μ Hz to 500 MHz HBW: 1 μ Hz to 1 GHz
Square	Fast transition enabled: SND: 1 μ Hz to 170 MHz HBW: 1 μ Hz to 300 MHz Fast transition disabled:	Fast transition enabled: SND: 1 μ Hz to 170 MHz HBW: 1 μ Hz to 300 MHz Fast transition disabled:

Waveform	DG6052/DG6054	DG6102/DG6104
	1 μ Hz to 120 MHz	1 μ Hz to 120 MHz
Ramp	1 μ Hz to 5 MHz	1 μ Hz to 5 MHz
Pulse	1 μ Hz to 120 MHz	1 μ Hz to 120 MHz
Arb	1 μ Hz to 100 MHz	1 μ Hz to 100 MHz
Harmonic	1 mHz to 175 MHz	1 mHz to 250 MHz

In SND output, the amplitude range is related to the impedance and frequency/period settings, as shown in [Table 5.2 SND Output Amplitude Range](#).

Table 5.2 SND Output Amplitude Range

Frequency	HighZ		Load (50 Ω)	
	Amplitude Range	Maximum Peak Value ^[1]	Amplitude Range	Maximum Peak Value ^[1]
≤ 100 MHz	2 mVpp to 20 Vpp	10 V	1 mVpp to 10 Vpp	5 V
≤ 250 MHz	2 mVpp to 10 Vpp	5 V	1 mVpp to 5 Vpp	2.5 V
≤ 350 MHz	2 mVpp to 4 Vpp	2 V	1 mVpp to 2 Vpp	1 V
≤ 500 MHz	2 mVpp to 2 Vpp	1 V	1 mVpp to 1 Vpp	500 mV

When the impedance is HighZ, if the amplitude range > 4 V or if the amplitude range ≤ 4 V and $|\text{offset}| > 2$ V - amplitude range/2, the effective output bandwidth (-3 dB) is 250 MHz (typical).

When the impedance is Load, if the amplitude range > 2 V or if the amplitude range ≤ 2 V and $|\text{offset}| > 1$ V - amplitude range/2, the effective output bandwidth (-3 dB) is 250 MHz (typical).

In differential output, the AMP amplitude range is related to the frequency/period setting, as shown in [Table 5.3 AMP Output Amplitude Range \(Load\)](#); the HBW amplitude range is related to the frequency/period setting, as shown in [Table 5.4 HBW Output Amplitude Range \(Load\)](#).

Table 5.3 AMP Output Amplitude Range (Load)

Frequency	Amplitude Range	Maximum Peak Value ^[1]
≤100 MHz	2 mVpp to 20 Vpp	10 V
≤250 MHz	2 mVpp to 10 Vpp	5 V
≤350 MHz	2 mVpp to 4 Vpp	2 V
≤500 MHz	2 mVpp to 2 Vpp	1 V

Table 5.4 HBW Output Amplitude Range (Load)

Frequency	Amplitude Range
≤500 MHz	400 mVpp to 2 Vpp
≤1 GHz	400 mVpp to 1 Vpp

**NOTE**

[1]: The maximum peak value is the maximum value of the waveform high level that can be set. The waveform amplitude range and offset are limited by this value: $\text{Amplitude range}/2 + |\text{Offset}| \leq \text{Maximum Peak Value}$.

5.1 To Output Sine Wave

In the Continuous mode, you can configure the instrument to output sine in the following ways.

- In the Continuous Setting Interface (*Figure 5.1*), click or tap the "Basic Wave Type" drop-down button to select "Sine".
- In the Continuous Setting Interface (*Figure 5.1*), click or tap the "Waveform Preview/Selection" area and then click or tap **Built In Wforms** > **Sine**.
- Press the front-panel  key.

In the setting interface for Sine wave, you can set the following parameters to create different sine waves as desired.

Set the Frequency/Period

Click or tap the **Freq/Period** button or press the front-panel  key to set the parameter to "Freq". "Freq" is now highlighted. Click or tap its input field and use the

pop-up numeric keypad to set the frequency for sine wave. By default, the frequency for sine wave is 1 kHz, and the resolution is 1 μ Hz. For available ranges of the sine frequency of different models, please refer to [Table 5.1 Range of Continuous Waveform Frequency](#). You can click or tap the **Freq/Period** button again or press the



key to toggle the parameter to "Period". $\text{Period} = 1/\text{Frequency}$.

Set the Amplitude Range (Differential)

When the output type is set to differential (AMP/HBW), click or tap the **DM Ampl**

input field or press the front-panel  key and use the pop-up numeric keypad to set the amplitude range. In AMP output type, the amplitude range of sine is 2.5 Vpp by default and is limited by the "Frequency/Period" and "CM Offset" settings. For details, refer to [Table 5.3 AMP Output Amplitude Range \(Load\)](#). In HBW output type, the amplitude range of sine is 2 Vpp by default and is limited by the "Frequency/Period" setting. For details, refer to [Table 5.4 HBW Output Amplitude Range \(Load\)](#).

Set the Amplitude Range/High Level (Single-ended)

When the output type is SND, click or tap the **Ampl/HighL** button or press the front-

panel  key to set the parameter to "Ampl". "Ampl" is now highlighted. Click or tap its input field and use the pop-up numeric keypad to set the amplitude range for sine wave. Available units for amplitude range include Vpp, Vrms, and dBm (not available in HighZ). In SND output type, the amplitude range of sine is 5 Vpp by default and is limited by the "Impedance", "Frequency/Period", and "Offset" settings. For details, refer to [Table 5.2 SND Output Amplitude Range](#).

Click or tap the **Ampl/HighL** button again or press the  key to toggle the parameter to "HighL". $\text{High Level} = \text{Offset} + \text{Amplitude Range}/2$. In SND output type, the high level range is related to the low level setting value. That is, high level minus low level cannot exceed the current amplitude range.

NOTE

1. How to convert the amplitude in Vpp to the corresponding value in Vrms?

Vpp is the unit for signal peak-peak value and Vrms is the unit for signal effective value. The default unit is Vpp. When setting the amplitude range with the pop-up numeric keypad, you can click or tap the unit drop-down button to select the desired unit and then click or tap "Enter" to confirm the current amplitude range unit setting. You cannot set the amplitude range in dBm or Vrms for Arb and Harmonic range.

The relationship between Vpp and Vrms varies for different waveforms. Take sine wave as an example. The relationship between the two units is as shown in the figure below.



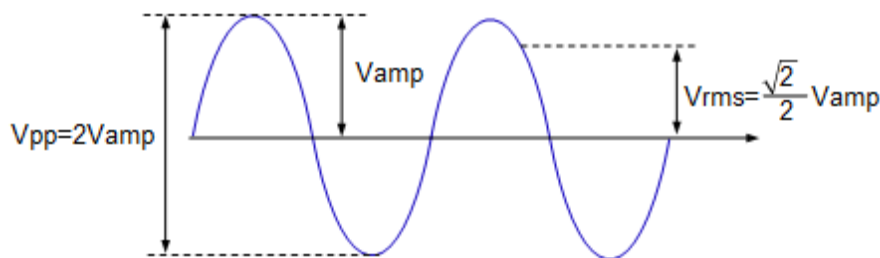

According to the figure above, the conversion relationship between Sine Vpp and Vrms fulfills the following equation:

$$V_{pp}=2\sqrt{2} V_{rms}$$

2. How to set the waveform amplitude range in the unit of dBm?

- Set the impedance to "Load" (refer to *Output Impedance*).
- When setting the amplitude range, click or tap the unit drop-down button to select "dBm" in the pop-up numeric keypad.
- Input the desired value and then click or tap "Enter" to set the waveform amplitude range in dBm.

dBm is the unit for signal power absolute value. The relationship between dBm and Vrms fulfills the following equation:

$$dBm = 10 \lg \left(\frac{V_{rms}^2}{R} \times \frac{1}{0.001W} \right)$$

W is the unit of the signal power. R represents the channel output impedance value which must be a certain value. Therefore, dBm is not available when the output impedance is set to "HighZ".

Set the Offset (Differential)

When the output type is set to differential (AMP/HBW), click or tap the **CM Offset**

input field or press the front-panel  key and use the pop-up numeric keypad to set the offset. In AMP output type, the offset range is limited by the "Frequency/Period" and "DM Ampl" settings, and the default is 0 Vdc; in HBW output type, the offset range is from -200 mVdc to 200 mVdc.

Set the Offset/Low Level (Single-ended)

When the output type is SND, click or tap the **Offset/LowL** button or press the front-

panel  key to set the parameter to "Offset". "Offset" is now highlighted. Click or tap its input field and use the pop-up numeric keypad to set the offset for sine wave. In SND output type, the offset of sine is limited by the "Impedance", "Frequency/Period", and "Ampl/HighL" settings. The default is 0 Vdc.

Click or tap the **Offset/LowL** button again or press the  key to toggle the parameter to "LowL". Low Level = Offset - Amplitude Range/2. In SND output type, the low level range is related to the high level setting value. That is, high level minus

low level cannot exceed the current amplitude range (*Table 5.2 SND Output Amplitude Range*).



TIP

The "Ampl" and "Offset" buttons appear at the same time, and so are "HighL" and "LowL" buttons. For example, selecting "Offset" automatically toggles the "Ampl/HighL" parameter to "Ampl".

Set the Starting Phase

Click or tap the **Phase** input field to set the starting phase, which ranges from -360° to 360°. The default phase is 0°, and the resolution is 0.01°.

5.2 To Output Square Wave

In the Continuous mode, you can configure the instrument to output square in the following ways.

- In the Continuous Setting Interface (*Figure 5.1*), click or tap the "Basic Wave Type" drop-down button to select "Square".
- In the Continuous Setting Interface (*Figure 5.1*), click or tap the "Waveform Preview/Selection" area and then click or tap **Built In Wforms** > **Square**.
- Press the front-panel  key.

In the setting interface for Square wave, you can set the following parameters to create different square waves as desired.

Set the Frequency/Period

Click or tap the **Freq/Period** button or press the front-panel  key to set the parameter to "Freq". "Freq" is now highlighted. Click or tap its input field and use the pop-up numeric keypad to set the frequency for square waveform. By default, the frequency for square is 1 kHz and the resolution is 1 μHz. For available ranges of the square frequency of different models, please refer to *Table 5.1 Range of Continuous Waveform Frequency*. You can click or tap the **Freq/Period** button again or press the



key to toggle the parameter to "Period". $\text{Period} = 1/\text{Frequency}$.

Set the Amplitude Range (Differential)

When the output type is set to differential (AMP/HBW), click or tap the **DM Ampl**

input field or press the front-panel  key and use the pop-up numeric keypad to set the amplitude range. In AMP output type, the amplitude range of square is 2.5 Vpp by default and is limited by the "Frequency/Period" and "CM Offset" settings. For details, refer to *Table 5.3 AMP Output Amplitude Range (Load)*. In HBW output type,

the amplitude range of square is 2 Vpp by default and is limited by the "Frequency/Period" setting. For details, refer to [Table 5.4 HBW Output Amplitude Range \(Load\)](#).

Set the Amplitude Range/High Level (Single-ended)

Click or tap the **Ampl/HighL** button or press the front-panel  key to set the parameter to "Ampl". "Ampl" is now highlighted. Click or tap its input field and use the pop-up numeric keypad to set the amplitude range for square waveform. Available units for amplitude range include Vpp, Vrms, and dBm (not available in HighZ). For how to set the amplitude range in Vrms or dBm, please refer to [To Output Sine Wave](#). In SND output type, the amplitude range of square is 5 Vpp by default and is limited by the "Impedance", "Frequency/Period", and "Offset" settings. For details, refer to [Table 5.2 SND Output Amplitude Range](#).

Click or tap the **Ampl/HighL** button again or press the  key to toggle the parameter to "HighL". High Level = Offset + Amplitude Range/2. In SND output type, the high level range is related to the low level setting value. That is, high level minus low level cannot exceed the current amplitude range.

Set the Offset (Differential)

When the output type is set to differential (AMP/HBW), click or tap the **CM Offset** input field or press the front-panel  key and use the pop-up numeric keypad to set the offset. In AMP output type, the offset range is limited by the "Frequency/Period" and "DM Ampl" settings, and the default is 0 Vdc; in HBW output type, the offset range is from -200 mVdc to 200 mVdc.

Set the Offset/Low Level (Single-ended)

Click or tap the **Offset/LowL** button or press the front-panel  key to set the parameter to "Offset". "Offset" is now highlighted. Click or tap its input field and use the pop-up numeric keypad to set the offset for square waveform. In SND output type, the offset of square is limited by the "Impedance", "Frequency/Period", and "Ampl/HighL" settings. The default is 0 Vdc.

Click or tap the **Offset/LowL** button again or press the  key to toggle the parameter to "LowL". Low Level = Offset - Amplitude Range/2. In SND output type, the low level range is related to the high level setting value. That is, high level minus low level cannot exceed the current amplitude range ([Table 5.2 SND Output Amplitude Range](#)).



TIP

The "Ampl" and "Offset" buttons appear at the same time, and so are "HighL" and "LowL" buttons. For example, selecting "Offset" automatically toggles the "Ampl/HighL" parameter to "Ampl".

Set the Starting Phase

Click or tap the **Phase** input field to set the starting phase, which ranges from -360° to 360°. The default phase is 0°, and the resolution is 0.01°.

Set the Duty Cycle

Duty cycle represents the amount of time per period that the square wave is at a high level, as shown in the figure below. The "Duty Cycle" parameter setting only appears when "Square" or "Pulse" is selected.

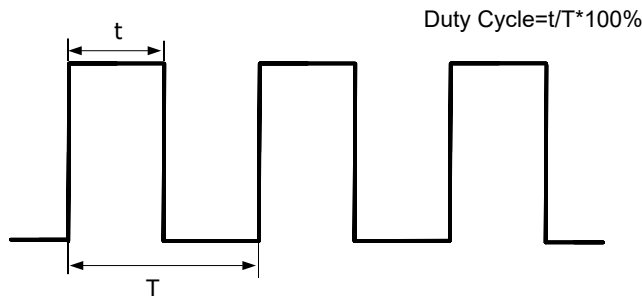

When **Fast Tran** is set to "On", the duty cycle of the square wave is fixed at 50% and cannot be set. When **Fast Tran** is set to "Off", click or tap the **Duty Cycle** input field to set the duty cycle. The available range is from 0.01% to 99.99%. By default, it is 50%, and the resolution is 0.01%.



NOTE

When the fast transition function is disabled, the actual available duty cycle is limited by the period: $(4.2 \text{ ns/Square Period}) \times 100\% \leq \text{Square Duty Cycle} \leq (1 - 4.2 \text{ ns/Square Period}) \times 100\%$.

Set the Fast Transition/Transition Time

When the output type is set to SND or HBW, in the Continuous output mode, the method for generating the edges of the square wave can be specified. Click or tap the **Fast Tran** on/off switch to enable or disable the fast transition function for square wave.

The frequency and duty cycle of the square wave are shown in the table below.

Fast Transition On/Off	Square Frequency	Square Duty Cycle
On	1 μHz to 170 MHz (SND) 1 μHz to 300 MHz (HBW)	Fixed at 50%
Off	1 μHz to 120 MHz	Settable, 0.01% to 99.99%

When the fast transition function is disabled, you cannot set the fast transition time. When the fast transition function is enabled, you can set the fast transition time for square wave. In SND output, the transition time ranges from 800 ps to 1 ns and the precision is 10 ps. In HBW output, the transition time is related to the frequency, as shown in the table below.

Square Frequency	Square Transition Time
≤170 MHz	700 ps to 1 ns
≤270 MHz	600 ps to 1 ns
≤300 MHz	350 ps to 1 ns

**TIP**

- In AMP output, the fast transition/time function is disabled. The transition time is fixed at 1.4 ns and cannot be set.
- The fast transition on/off and transition time can be set for square wave only in Continuous mode. When the output mode is set to Burst, Sweep, or Modulation for the specified channel, the fast transition is automatically disabled and the transition time cannot be modified.

5.3 To Output Ramp Wave

In the Continuous mode, you can configure the instrument to output ramp in the following ways.

- In the Continuous Setting Interface (*Figure 5.1*), click or tap the "Basic Wave Type" drop-down button to select "Ramp".
- In the Continuous Setting Interface (*Figure 5.1*), click or tap the "Waveform Preview/Selection" area and then click or tap **Built In Wforms** > **Ramp**.
- Press the front-panel  key.

In the setting interface for Ramp wave, you can set the following parameters to create different ramp waves as desired.

Set the Frequency/Period

Click or tap the **Freq/Period** button or press the front-panel  key to set the parameter to "Freq". "Freq" is now highlighted. Click or tap its input field and use the pop-up numeric keypad to set the frequency for ramp waveform. By default, the frequency for ramp wave is 1 kHz and the resolution is 1 μHz. For available ranges of the ramp frequency of different models, please refer to *Table 5.1 Range of Continuous Waveform Frequency*. You can click or tap the **Freq/Period** button again or press the

 key to toggle the parameter to "Period". Period = 1/Frequency.

Set the Amplitude Range (Differential)

When the output type is set to differential (AMP/HBW), click or tap the **DM Ampl**

input field or press the front-panel  key and use the pop-up numeric keypad to set the amplitude range. In AMP output type, the amplitude range of ramp is 2.5 Vpp

by default and is limited by the "Frequency/Period" and "CM Offset" settings. For details, refer to [Table 5.3 AMP Output Amplitude Range \(Load\)](#). In HBW output type, the amplitude range of ramp is 2 Vpp by default and is limited by the "Frequency/Period" setting. For details, refer to [Table 5.4 HBW Output Amplitude Range \(Load\)](#).

Set the Amplitude Range/High Level (Single-ended)

Click or tap the **Ampl/HighL** button or press the front-panel  key to set the parameter to "Ampl". "Ampl" is now highlighted. Click or tap its input field and use the pop-up numeric keypad to set the amplitude range for ramp wave. Available units for amplitude range include Vpp, Vrms, and dBm (not available in HighZ). For how to set the amplitude range in Vrms or dBm, please refer to [To Output Sine Wave](#). In SND output type, the amplitude range of ramp is 5 Vpp by default and is limited by the "Impedance", "Frequency/Period", and "Offset" settings. For details, refer to [Table 5.2 SND Output Amplitude Range](#).

Click or tap the **Ampl/HighL** button again or press the  key to toggle the parameter to "HighL". High Level = Offset + Amplitude Range/2. In SND output type, the high level range is related to the low level setting value. That is, high level minus low level cannot exceed the current amplitude range.

Set the Offset (Differential)

When the output type is set to differential (AMP/HBW), click or tap the **CM Offset** input field or press the front-panel  key and use the pop-up numeric keypad to set the offset. In AMP output type, the offset range is limited by the "Frequency/Period" and "DM Ampl" settings, and the default is 0 Vdc; in HBW output type, the offset range is from -200 mVdc to 200 mVdc.

Set the Offset/Low Level (Single-ended)

Click or tap the **Offset/LowL** button or press the front-panel  key to set the parameter to "Offset". "Offset" is now highlighted. Click or tap its input field and use the pop-up numeric keypad to set the offset for ramp waveform. In SND output type, the offset of ramp is limited by the "Impedance", "Frequency/Period", and "Ampl/HighL" settings. The default is 0 Vdc.

Click or tap the **Offset/LowL** button again or press the  key to toggle the parameter to "LowL". Low Level = Offset - Amplitude Range/2. In SND output type, the low level range is related to the high level setting value. That is, high level minus low level cannot exceed the current amplitude range ([Table 5.2 SND Output Amplitude Range](#)).

TIP



The "Ampl" and "Offset" buttons appear at the same time, and so are "HighL" and "LowL" buttons. For example, selecting "Offset" automatically toggles the "Ampl/HighL" parameter to "Ampl".

Set the Starting Phase

Click or tap the **Phase** input field to set the starting phase, which ranges from -360° to 360° . The default phase is 0° , and the resolution is 0.01° .

Set the Symmetry

Symmetry is defined as the percentage of the amount of time Ramp wave is rising in the period, as shown in the figure below. It only appears when "Ramp" is selected.

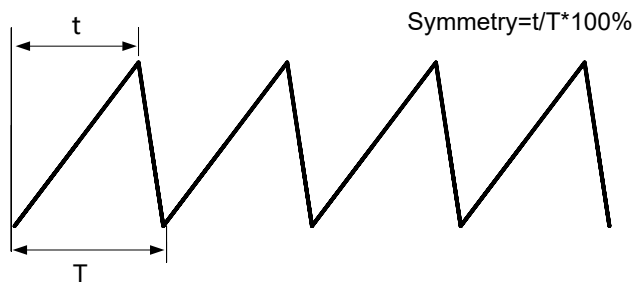

Click or tap the **Symmetry** input field to set the symmetry, which ranges from 0.1% to 99.9%. The default value is 50%, and the resolution is 0.1%. In actual use, the symmetry is limited by the period, that is, $20 \text{ ns} \leq \text{Symmetry} * \text{Period} \leq \text{Period} - 20 \text{ ns}$.

5.4 To Output Pulse

In the Continuous mode, you can configure the instrument to output pulse in the following ways.

- In the Continuous Setting Interface (*Figure 5.1*), click or tap the "Basic Wave Type" drop-down button to select "Pulse".
- In the Continuous Setting Interface (*Figure 5.1*), click or tap the "Waveform Preview/Selection" area and then click or tap **Built In Wforms > Pulse**.
- Press the front-panel  key.

In addition to basic parameters (e.g. Frequency, Amplitude Range, Offset, Starting Phase, High Level, Low Level) mentioned before, you also need to set the "Pulse Width/Duty Cycle", "Rising Edge", and "Falling Edge".

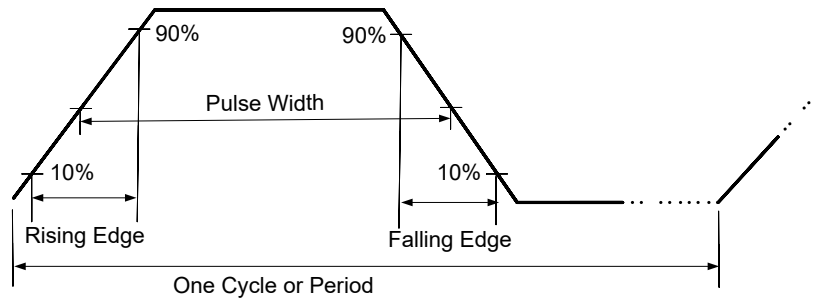

Set the Frequency/Period

Click or tap the **Freq/Period** button or press the front-panel  key to set the parameter to "Freq". "Freq" is now highlighted. Click or tap its input field and use the pop-up numeric keypad to set the frequency for pulse waveform. By default, the frequency for Pulse is 1 kHz and the resolution is 1 μ Hz. For available ranges of the pulse frequency of different models, please refer to [Table 5.1 Range of Continuous Waveform Frequency](#). You can click or tap the **Freq/Period** button again or press the

 key to toggle the parameter to "Period". $\text{Period} = 1/\text{Frequency}$.

Set the Amplitude Range (Differential)

When the output type is set to differential (AMP/HBW), click or tap the **DM Ampl** input field or press the front-panel  key and use the pop-up numeric keypad to set the amplitude range. In AMP output type, the amplitude range of pulse is 2.5 Vpp by default and is limited by the "Frequency/Period" and "CM Offset" settings. For details, refer to [Table 5.3 AMP Output Amplitude Range \(Load\)](#). In HBW output type, the amplitude range of pulse is 2 Vpp by default and is limited by the "Frequency/Period" setting. For details, refer to [Table 5.4 HBW Output Amplitude Range \(Load\)](#).

Set the Amplitude Range/High Level (Single-ended)

Click or tap the **Ampl/HighL** button or press the front-panel  key to set the parameter to "Ampl". "Ampl" is now highlighted. Click or tap its input field and use the pop-up numeric keypad to set the amplitude range for pulse waveform. Available units for amplitude range include Vpp, Vrms, and dBm (not available in HighZ). For how to set the amplitude range in Vrms or dBm, please refer to [To Output Sine Wave](#). In SND output type, the amplitude range of pulse is 5 Vpp by default and is limited by the "Impedance", "Frequency/Period", and "Offset" settings. For details, refer to [Table 5.2 SND Output Amplitude Range](#).

Click or tap the **Ampl/HighL** button again or press the  key to toggle the parameter to "HighL". $\text{High Level} = \text{Offset} + \text{Amplitude Range}/2$. In SND output type, the high level range is related to the low level setting value. That is, high level minus low level cannot exceed the current amplitude range ([Table 5.2 SND Output Amplitude Range](#)).

Set the Offset (Differential)

When the output type is set to differential (AMP/HBW), click or tap the **CM Offset** input field or press the front-panel  key and use the pop-up numeric keypad to set the offset. In AMP output type, the offset range is limited by the "Frequency/Period" and "DM Ampl" settings, and the default is 0 Vdc; in HBW output type, the offset range is from -200 mVdc to 200 mVdc.

Set the Offset/Low Level (Single-ended)

Click or tap the **Offset/LowL** button or press the front-panel  key to set the parameter to "Offset". "Offset" is now highlighted. Click or tap its input field and use the pop-up numeric keypad to set the offset for pulse waveform. In SND output type, the offset of pulse is limited by the "Impedance", "Frequency/Period", and "Ampl/HighL" settings. The default is 0 Vdc.

Click or tap the **Offset/LowL** button again or press the  key to toggle the parameter to "LowL". Low Level = Offset - Amplitude Range/2. In SND output type, the low level range is related to the high level setting value. That is, high level minus low level cannot exceed the current amplitude range ([Table 5.2 SND Output Amplitude Range](#)).

TIP

The "Ampl" and "Offset" buttons appear at the same time, and so are "HighL" and "LowL" buttons. For example, selecting "Offset" automatically toggles the "Ampl/HighL" parameter to "Ampl".

Set the Starting Phase

Click or tap the **Phase** input field to set the starting phase, which ranges from -360° to 360°. The default phase is 0°, and the resolution is 0.01°.

Set the Pulse Width/Duty Cycle

Pulse width is the time from the 50% threshold of a pulse's rising edge to the 50% threshold of the next falling edge, as shown in the figure above. The pulse duty cycle is defined as the percentage of the pulse width to the pulse period. Changing one of them automatically modifies the other.

Click or tap the **Width/Duty** button to set the parameter to "Width". "Width" is now highlighted. Click or tap its input field and use the pop-up numeric keypad to set the pulse width. The available range is from 4.2 ns to 999.9 ks. The default value is 500 μ s and the resolution is 0.1 ns.

Click or tap the button to toggle the parameter to "Duty". Duty Cycle = Pulse Width/Period. The available range is from 0.01% to 99.99%. The default value is 50% and the resolution is 0.01%.



**TIP**

- The pulse width must conform to the following restrictions determined by the period and the minimum pulse width (W_{min} : 4.2 ns): Minimum Pulse Width \leq Pulse Width \leq (Period - Minimum Pulse Width).
- The pulse duty cycle must conform to the following restrictions determined by the minimum pulse width and pulse period: (Minimum Pulse Width/Period)*100% \leq Pulse Duty Cycle \leq (1 - Minimum Pulse Width/Period)*100%.

Set the Leading/Trailing Edge

The leading (rising) edge time is the time it takes for the pulse level to go from 10% to 90%; trailing (falling) edge time is the time it takes for the pulse level to go from 90% to 10%.

Click or tap the **Leading/Trailing** input field and use the pop-up numeric keypad to set the leading edge time/trailing edge time. The leading/trailing edge time ranges from 1.4 ns to 1 s (limited by the pulse width). The default value is 1.4 ns and the resolution is 0.1 ns.

5.5 To Output Noise

In the Continuous mode, you can configure the instrument to output noise in the following ways.

- In the Continuous Setting Interface (*Figure 5.1*), click or tap the "Basic Wave Type" drop-down button to select "Noise".
- In the Continuous Setting Interface (*Figure 5.1*), click or tap the "Waveform Preview/Selection" area and then click or tap **Built In Wforms > Noise**.
- Press the front-panel  key.

In the setting interface for Noise, you can set the following parameters to create different noises as desired.

Set the Amplitude Range (Differential)

When the output type is set to differential (AMP/HBW), click or tap the **DM Ampl** input field or press the front-panel  key and use the pop-up numeric keypad to set the amplitude range. For AMP output, the amplitude range of noise is limited by the offset. It ranges from 2 mVpp to 2 Vpp and the default is 2 Vpp. For HBW output, the amplitude range of noise is from 400 mVpp to 2 Vpp and the default is 2 Vpp.

Set the Amplitude Range/High Level (Single-ended)

Click or tap the **Ampl/HighL** button or press the front-panel  key to set the parameter to "Ampl". "Ampl" is now highlighted. Click or tap its input field and use the pop-up numeric keypad to set the amplitude range for noise. Available units for

amplitude range include Vpp, Vrms, and dBm (not available in HighZ). In SND output type, the available amplitude range is related to the "Impedance" setting and is limited by the "Offset" setting.

- HighZ: 2 mVpp to 2 Vpp, and $\text{Amplitude Range}/2 + |\text{Offset}| \leq 1 \text{ Vpp}$.
- Load (50 Ω): 1 mVpp to 1 Vpp, and $\text{Amplitude Range}/2 + |\text{Offset}| \leq 500 \text{ mVpp}$.

Click or tap the **Ampl/HighL** button again or press the  key to toggle the parameter to "HighL". High Level = Offset + Amplitude Range/2. In SND output type, the high level range is related to the low level setting value. That is, high level minus low level cannot exceed the current amplitude range.

Set the Offset (Differential)

When the output type is set to differential (AMP/HBW), click or tap the **CM Offset** input field or press the front-panel  key and use the pop-up numeric keypad to set the offset. In AMP output type, the offset range is limited by the "DM Ampl" setting, and the default is 0 Vdc; in HBW output type, the offset range is from -200 mVdc to 200 mVdc.

Set the Offset/Low Level (Single-ended)

Click or tap the **Offset/LowL** button or press the front-panel  key to set the parameter to "Offset". "Offset" is now highlighted. Click or tap its input field and use the pop-up numeric keypad to set the offset for noise. In SND output type, the offset of noise is limited by the "Impedance" and "Ampl/HighL" settings. The default is 0 Vdc.

Click or tap the **Offset/LowL** button again or press the  key to toggle the parameter to "LowL". Low Level = Offset - Amplitude Range/2. In SND output type, the low level range is related to the high level setting value. That is, high level minus low level cannot exceed the current amplitude range ([Table 5.2 SND Output Amplitude Range](#)).



TIP

The "Ampl" and "Offset" buttons appear at the same time, and so are "HighL" and "LowL" buttons. For example, selecting "Offset" automatically toggles the "Ampl/HighL" parameter to "Ampl".

5.6 To Output DC (SND Only)

The DC output is not available when the output type is set to differential (AMP/HBW). When the output type is set to SND, in the Continuous mode, you can configure the instrument to output DC waveform in the following ways.

- In the Continuous Setting Interface (*Figure 5.1*), click or tap the "Basic Wave Type" drop-down button to select "DC".
- In the Continuous Setting Interface (*Figure 5.1*), click or tap the "Waveform Preview/Selection" area and then click or tap **Built In Wforms > DC**.

After entering the DC setting interface, you can set the offset for the DC waveform. In SND output type, the range of DC offset is related to the "Impedance" setting.

- HighZ: -10 Vdc to +10 Vdc.
- Load (50 Ω): -5 Vdc to +5 Vdc.

5.7 To Output Arbitrary Waveforms

DG6000 supports Arb output in both Continuous mode and Advanced mode. In the Continuous mode, DG6000 outputs waveforms by the traditional DDS method. The output frequency ranges from 1 μ Hz to 100 MHz and the sample rate is fixed to 2.5 GSa/s. This section introduces how to output arbitrary waveforms in the Continuous mode.

TIP

If you want to change the sample rate and output the arbitrary waveforms point by point, switch to the Advanced mode (*Advanced Mode*).

Select the Data Source

- **Stored Waveforms**

In the Continuous Setting Interface (*Figure 5.1*), click or tap the "Waveform Preview/Selection" area and then click or tap **Stored Wforms** in the displayed menu to open the storage menu. Select the Arb file (*.arb/*.csv/*.txt) that you want to load from the internal memory (C disk) or the external storage device (D disk) and then click or tap **Load**. After loading, the data in the current volatile memory space will change. You can use the instrument's Arb editor to edit and save the Arb Waveform (*.arb only). You can also edit the Arb waveform through the PC software and download it into the instrument. It is recommended to use the PC software Ultra Station provided by RIGOL. The installation package and help manual of the software can be obtained from RIGOL official website.

TIP

- The non-advanced output mode only supports arbitrary waveforms with the length of 16,384 pts.
- DG6000 does not support loading Arb files with file headers. It is recommended to use Ultra Station 00.02.01.00.01 or later to generate Arb waveforms and untick the "Save File With Header" box or select the DG6000 format when saving the file.

**NOTE**

DG6000 supports arb files in *.arb, *.csv, and *.txt formats.

- *.arb files are data files that store binary values.
- *.csv files are voltage data stored in plain text, floating type.
- *.txt files are plaintext voltage data (floating) or normalized wave point data (-32768 to +32767) files separated by separators (enter, comma, or semicolon). Only one data format and separator can be used in the same file. When loading the *.txt file, select the correct file data format and data separator in the pop-up sub-menu.

- **Built-in Waveforms**

In the Continuous Setting Interface (*Figure 5.1*), click or tap the "Waveform Preview/Selection" area and then click or tap **Built In Wforms** in the displayed menu to open the built-in waveform selection menu. You click or tap **Common**, **Engine**, **Seg Mod**, **Bioelect**, **Medical**, **Standard**, **Maths**, **Trigonome**, **Anti Trigonome**, and **Window Function** to select your desired Arb waveform. The selected waveform type is indicated in **Shape** in the Arb setting interface.

Table 5.7 Built-in Waveforms

Name	Descriptions
Common	
Absine	Sine absolute value
Absinehalf	Half-sine absolute value
Ampalt	Gain oscillation curve
Attalt	Attenuation oscillation curve
Gausspulse	Gaussian pulse
Negramp	Negative ramp
Npulse	Negative pulse
Ppulse	Positive pulse
Posramp	Positive ramp
Sinetra	Sine-Tra waveform
Sinever	Sine-Ver waveform
Stair Dn	Stair down
Stair Ud	Stair up/down
Stair Up	Stair up
Trapezia	Trapezia
Engineering	
2ndosr01	2nd order step response (attenuation constant: 0.1)
2ndosr02	2nd order step response (attenuation constant: 0.2)

Name	Descriptions
2ndosr07	2nd order step response (attenuation constant: 0.7)
2ndoir01	2nd order impulse response (attenuation constant: 0.1)
2ndoir02	2nd order impulse response (attenuation constant: 0.2)
2ndoir07	2nd order impulse response (attenuation constant: 0.7)
Prbs9	Pseudo-Random Binary Sequence of order 9
Prbs11	Pseudo-Random Binary Sequence of order 11
Prbs15	Pseudo-Random Binary Sequence of order 15
Prbs16	Pseudo-Random Binary Sequence of order 16
Prbs20	Pseudo-Random Binary Sequence of order 20
Prbs21	Pseudo-Random Binary Sequence of order 21
Prbs23	Pseudo-Random Binary Sequence of order 23
Three Tone	Three-tone signal
Four Tone	Four-tone signal
Five Tone	Five-tone signal
Six Tone	Six-tone signal
Seven Tone	Seven-tone signal
Eight Tone	Eight-tone signal
Bandlimited	Band-limited signal
Blaseiwave	Time-velocity curve
Butterworth	Butterworth filter
Chebyshev1	Type I Chebyshev filter
Chebyshev2	Type II Chebyshev filter
Combin	Combination function
Cpulse	C-Pulse signal
Cw Pulse	CW pulse signal
Damped Osc	Damped oscillation time-offset curve
Distortion	Distorted waveform
Dampedsine1	Damped sine wave (1 Hz frequency)
Dampedsine3	Damped sine wave (3 Hz frequency)
Dampedsine5	Damped sine wave (5 Hz frequency)
Dualtone	Dual-tone signal
Gamma	Gamma signal
Gatevibr	Gate self-excited oscillating signal
Lfm Pulse	Linear frequency modulation pulse signal
LowerSemicircle	Lower semicircle

Name	Descriptions
Mcnoise	Mechanical noise
Nimh Discharge	Discharge curve of NiMH batteries
Neg halvesine	Negative half cycle of sine wave
Pos Hwrsine	Half wave rectifier of sine (positive)
Neg Hwrsine	Half wave rectifier of sine (negative)
Pos Fwrsine	Full wave rectifier of sine (positive)
Neg Fwrsine	Full wave rectifier of sine (negative)
Pahcur	DC brushless motor current waveform
Quake	Earthquake wave
Radar	Radar signal
Ripple	Power ripple
Roundhalf	Roundhalf waveform
Stepresp	Step response signal
Swing Osc	Swing oscillation kinetic energy-time curve
TV	TV signal
Voice	Voice signal
Segment Modulation	
Three Am	Sine piecewise AM waveform
Three Fm	Sine piecewise FM waveform
Three Pfm	Pulse piecewise FM waveform
Three Pm	Sine piecewise PM waveform
Three Pwm	Pulse width piecewise FM waveform
Bioelectricity	
Cardiac	Cardiac signal
Ecg1	Electrocardiogram 1
Ecg2	Electrocardiogram 2
Ecg3	Electrocardiogram 3
Ecg4	Electrocardiogram 4
Ecg5	Electrocardiogram 5
Ecg6	Electrocardiogram 6
Ecg7	Electrocardiogram 7
Ecg8	Electrocardiogram 8
Ecg9	Electrocardiogram 9
Ecg10	Electrocardiogram 10
Ecg11	Electrocardiogram 11
Ecg12	Electrocardiogram 12
Ecg13	Electrocardiogram 13
Ecg14	Electrocardiogram 14
Ecg15	Electrocardiogram 15
Eog	Electro-oculogram (EOG)
Eeg	Electroencephalo-graph (EEG)

Name	Descriptions
Emg	Electromyography (EMG)
Pulsilogram	Pulsilogram
Resspeed	Speed curve of the respiration
Medical	
Lf Pulse	Low frequency pulse electrotherapy waveform
Tens1	Transcutaneous Electric Nerve Stimulation (TENS) waveform 1
Tens2	Transcutaneous Electric Nerve Stimulation (TENS) waveform 2
Tens3	Transcutaneous Electric Nerve Stimulation (TENS) waveform 3
Standard	
Ignition	Ignition waveform of the automotive motor
Iso16750 2 Sp	Automotive starting profile with ringing
Iso16750 2 Vr	Automotive supply voltage profile for resetting
Iso16750 2 Vit	Voltage discontinuous, variable interrupt time
Iso16750 2 VRT	Voltage discontinuous, variable recovery time
Iso16750 2 LD1	Transients due to battery disconnect from the generator
Iso16750 2 LD2	Transients due to battery disconnect from the generator
Iso7637 2 Tp1	Automotive transients due to disconnects
Iso7637 2 Tp2a	Automotive transients due to inductance in wiring
Iso7637 2 Tp2b	Automotive transients due ignition switching off
Iso7637 2 Tp3a	Automotive transients due to switching
Iso7637 2 Tp3b	Automotive transients due to switching
Iso7637 2 Tp4	Automotive supply profile during starting
Iso7637 2 Tp5a	Automotive transients due to battery disconnect
Iso7637 2 Tp5b	Automotive transients due to battery disconnect
Scr	SCR firing profile
Surge	Surge signal
Maths	
Airy	Airy function
Airyai	AiryAi
Airybi	AiryBi
Besselj	Bessell function
Bessely	Besselll function
Cauchy	Cauchy distribution function

Name	Descriptions
Chebyshev3	3rd order Chebyshev polynomial
Chebyshev4	4th order Chebyshev polynomial
Chebyshev5	5th order Chebyshev polynomial
Chebyshev6	6th order Chebyshev polynomial
Chebyshev7	7th order Chebyshev polynomial
Chebyshev8	8th order Chebyshev polynomial
Chebyshev9	9th order Chebyshev polynomial
Chebyshev10	10th order Chebyshev polynomial
Clausen	Clausen function
Cubic	Cubic function
Dirichlet	Dirichlet function
Erf	Error function
Erfc	Complementary error function
Erfcinv	Inverted complementary error function
Erfinv	Inverted error function
Expfall	Exponential fall function
Exprise	Exponential rise function
Gabor1	Garbor function 1
Gabor3	Garbor function 3
Gammaln	Inverse Gamma function
Gauss	Gaussian distribution (also known as normal distribution)
Gaussderiv	Gaussian derivative
Gausshermite1	Gauss-Helmert function 1
Gausshermite2	Gauss-Helmert function 2
Gausshermite3	Gauss-Helmert function 3
Gausshermite4	Gauss-Helmert function 4
Haversine	HaverSine function
Laguerre	Laguerre polynomial
Laguerre2	2nd order Laguerre polynomial
Laguerre3	3rd order Laguerre polynomial
Laguerre4	4th order Laguerre polynomial
Laguerre5	5th order Laguerre polynomial
Laguerre6	6th order Laguerre polynomial
Laguerre7	7th order Laguerre polynomial
Laguerre8	8th order Laguerre polynomial
Laguerre9	9th order Laguerre polynomial
Laplace	Laplace distribution
Legend	Quintic Legendre polynomial
Legendre3	3rd order Legendre polynomial
Legendre4	4th order Legendre polynomial
Legendre5	5th order Legendre polynomial

Name	Descriptions
Legendre6	6th order Legendre polynomial
Legendre7	7th order Legendre polynomial
Legendre8	8th order Legendre polynomial
Legendre9	9th order Legendre polynomial
Legendre10	10th order Legendre polynomial
Log	Logarithmic function with the base of 10
Lognormal	Logarithmic normal distribution
Lorentz	Lorentz function
Mathieu1	1st order Mathieu function
Mathieu3	3rd order Mathieu function
Mathieu5	5th order Mathieu function
Maxwell	Maxwell distribution
Modbesseli0	Modified Bessel function
Rayleigh	Rayleigh distribution
Sphbesselj1	Spherical Bessel function of the first kind
Sphbesselj2	Spherical Bessel function of the second kind
Tick	Check-shaped function
Versiera	Versiera
Weibull	Weibull distribution
Weierstrass	Weierstrass function
X2	Square function
X3	Cubic function
Trigonome	
Cosh	Hyperbolic cosine
Coshc	Normalized Hyperbolic cosine
Cosint	Cosine integral
Cot	Cotangent function
Coth Con	Concave hyperbolic cotangent
Coth Pro	Protuberant hyperbolic cotangent
Csc Con	Concave cosecant
Csc Pro	Protuberant cosecant
Csch Con	Concave hyperbolic cosecant
Csch Pro	Protuberant hyperbolic cosecant
Recip Con	Concave reciprocal
Recip Pro	Protuberant reciprocal
Sec Con	Concave secant
Sec Pro	Protuberant secant
Sech	Hyperbolic secant
Sinc	Sinc function
Sinh	Hyperbolic sine
Sinhc	Normalized Hyperbolic sine

Name	Descriptions
Sinint	Integral sine
Sqrt	Square root
Tan	Tangent
Tanh	Hyperbolic tangent
Tanhc	Normalized Hyperbolic tangent
Anti Trigonome	
Acos	Arc cosine
Acosh	Arc hyperbolic cosine
Acot	Inverse cotangent function
Acot Con	Concave arc cotangent
Acot Pro	Protuberant arc cotangent
Acoth Con	Concave arc hyperbolic cotangent
Acoth Pro	Protuberant arc hyperbolic cotangent
Acsc Con	Concave arc cosecant
Acsc Pro	Protuberant arc cosecant
Acsch Con	Concave arc hyperbolic cosecant
Acsch Pro	Protuberant arc hyperbolic cosecant
Archav	Inverse haversine function
Archcv	Inverse hacoversed sine function
Asec Con	Concave arc secant
Asec Pro	Protuberant arc secant
Asech	Arc hyperbolic secant
Asin	Arc Sinc
Asinh	Arc hyperbolic sine
Atan	Arc tangent
Atanh	Arc hyperbolic tangent
Window Function	
Barlett	Bartlett window
Barthannwin	Modified Bartlett window
Blackman	Blackman window
Blackman H	BlackmanH window
Bohmanwin	Bohman window
Boxcar	Rectangle window
Chebwin	Chebyshev window
Flattopwin	Flat-top window
Hamming	Hamming window
Hanning	Hanning window
Kaiser	Kaiser window
Nuttallwin	Nuttall-defined minimum 4-term Blackman-Harris window
Parzenwin	Parzen window
Taylorwin	Taylor window

Name	Descriptions
Triang	Triangle window (also Fejer window)
Tukeywin	Tukey window

Set the Waveform Parameters

After selecting the waveform, you can set the frequency/period, amplitude range (differential), amplitude range/high level (single-ended), offset (differential), offset/low level (single-ended), and phase. To set the waveform parameters and output, please refer to *To Output Sine Wave*.

5.8 To Output Harmonic

DG6000 can be used as a harmonic generator to output harmonics with the specified order, amplitude range, and phase. It is usually used in the test of harmonic detector device or harmonic filter device. According to Fourier transform, time domain waveform is the superposition of a series of sine waveforms as shown in the equation below:

$$f(t) = A_1 \sin(2\pi f_1 t + \varphi_1) + A_2 \sin(2\pi f_2 t + \varphi_2) + A_3 \sin(2\pi f_3 t + \varphi_3) + \dots$$

Generally, the component with f_1 frequency is called the fundamental waveform, with f_1 as the fundamental frequency, A_1 as the fundamental amplitude range, and φ_1 as the fundamental phase. The frequencies of the other components (called harmonics) are all integral multiples of the fundamental frequency.

In the Continuous Setting Interface (*Figure 5.1*), click or tap the "Basic Wave Type" drop-down button to select "Harmonic". You can also click or tap the "Waveform Preview/Selection" area and then click or tap **Built In Wforms > Harmonic** in the displayed menu to enter the Harmonic Setting Interface, as shown in the figure below.

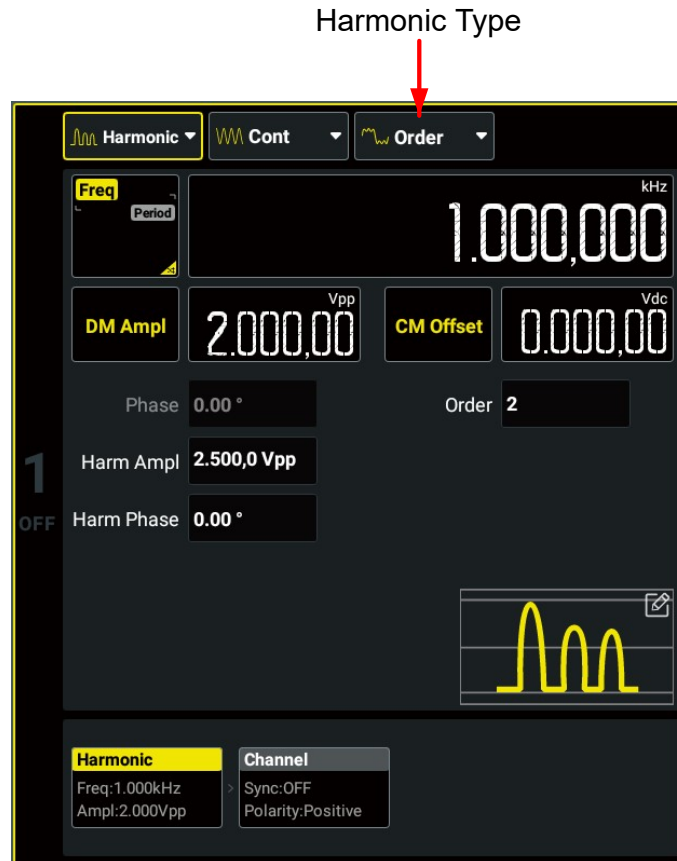

Figure 5.2 Harmonic Setting Interface

Fundamental Waveform Parameters

DG6000 allows you to set the frequency/period, amplitude range (differential), amplitude range/high level (single-ended), offset (differential), and offset/low level (single-ended) for fundamental waveforms. You can refer to [To Output Sine Wave](#) to set the above parameters. Note that V_{rms} and dBm are not available for the unit of the fundamental amplitude range.

TIP

The max. fundamental frequency (F_{fund}) is limited by the harmonic order (N) and max. harmonic frequency (F_{max}): $F_{fund} = (2 \times F_{max} \div N)$. Changing the harmonic order may modify the fundamental frequency. For the max. harmonic frequency (F_{max}) of different models, refer to [Table 5.1 Range of Continuous Waveform Frequency](#).

Harmonic Type

Click or tap the "Harmonic Type" drop-down button to select the desired type.

- **Order:** only outputs the fundamental waveform and the specified harmonic component. For example, if the **Order** is set to 5, the instrument will output the fundamental waveform and the 5th harmonic component.

- Combine:** outputs harmonics with multiple harmonic components.
 In this mode, 20 bits binary data are used to represent the output status of the 20 orders of harmonics respectively; wherein, 1 represents enabling the output of the corresponding harmonic and 0 represents disabling the output of the corresponding harmonic. Click or tap the **User** input field and use the pop-up virtual keypad to set the value of each data bit. Note that the leftmost bit representing fundamental waveform is always X and can not be modified. For example, set the 20 bits data to X001 0000 0000 0000 0001 and then fundamental waveform as well as 4th and 20th orders of harmonics will be output.

Order Harmonic

Click or tap the "Harmonic Type" drop-down button to select "Order" to enter the setting menu. Click or tap the **Order** input field to set the order. It ranges from 2 (default) to 20. After that, you can set the harmonic amplitude range and phase.

- Harmonic Amplitude Range:** click or tap the **Harm Ampl** input field to set the amplitude range with the pop-up virtual keypad.
- Harmonic Phase:** click or tap the **Harm Phase** input field to set the phase with the pop-up virtual keypad.

Combine Harmonic

Click or tap the "Harmonic Type" drop-down button to select "Combine" to enter the setting menu. Click or tap the **User** input field to set the user-defined orders of harmonics. After that, you can click or tap the harmonic editing table to set the amplitude range and phase in the pop-up menu.

SN	Amplitude	Phase
2	5,000,0 Vpp	0.00 °
3	5,000,0 Vpp	0.00 °
4	5,000,0 Vpp	0.00 °
5	5,000,0 Vpp	0.00 °
6	5,000,0 Vpp	0.00 °
7	5,000,0 Vpp	0.00 °
8	5,000,0 Vpp	0.00 °

Figure 5.3 Table Editing Menu

- **Harmonic Amplitude Range:** click or tap any cell in the **Amplitude** column and use the pop-up virtual keypad to set the amplitude range for the harmonic with the specified order.
- **Harmonic Phase:** click or tap any cell in the **Phase** column and use the pop-up virtual keypad to set the phase for the harmonic with the specified order.

**TIP**

You can click or tap the **SN** input field to set the order to locate the specified harmonic quickly.

6 Modulation

DG6000 allows you to output various modulated waveforms. Available modulation types include AM, FM, PM, ASK, FSK, PSK, PWM, and SUM. Both internal and external modulation sources are available for modulating waveforms.

Click or tap the "Output Mode" drop-down button to select "Mod" and access the interface as shown in the figure below. You can click or tap one of the tabs at the bottom to access the Continuous (Carrier) Setting Interface, Modulation Setting Interface, or Channel Setup Interface. For Continuous (Carrier) Setting Interface and Channel Setup Interface, please refer to *Continuous* and *Channel Setup* respectively. This chapter only describes the modulation settings.

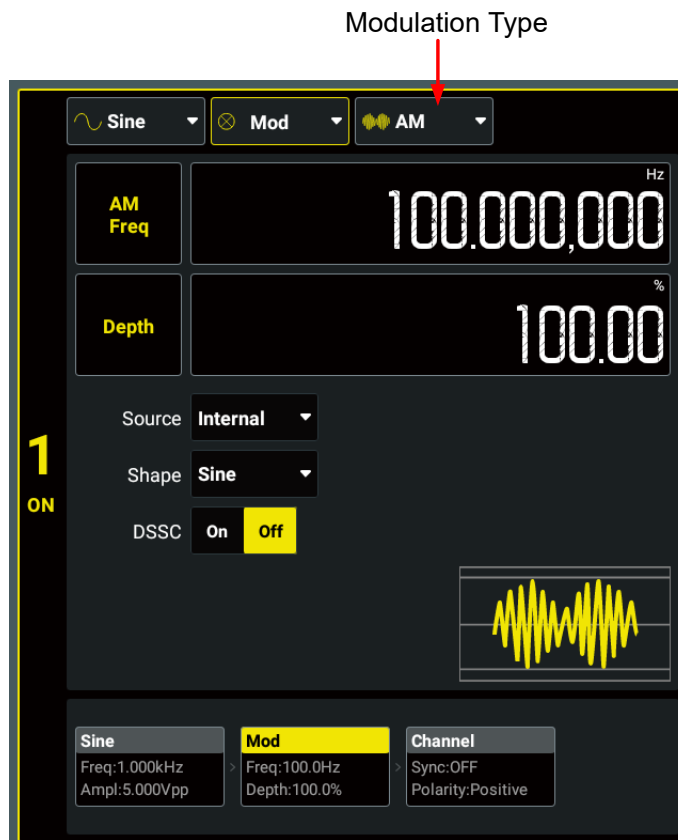

Figure 6.1 Modulation Setting Interface

The following table shows the range of the frequency for different carriers in the Modulation mode.

Table 6.1 Carrier Frequency Range (Modulation Mode)

Waveform	Carrier Frequency Range
Sine	1 μHz to 350 MHz

Waveform	Carrier Frequency Range
Square	1 μ Hz to 120 MHz
Ramp	1 μ Hz to 2.5 MHz
Pulse (PWM only)	1 μ Hz to 120 MHz
Arb	1 μ Hz to 100 MHz

6.1 Amplitude Modulation (AM)

In Amplitude Modulation (AM), a modulated waveform consists of a carrier waveform and a modulating waveform. The amplitude of the carrier waveform is varied by the instantaneous voltage of the modulating waveform. In the "Modulation Setting Interface" ([Figure 6.1](#)), click or tap the "Modulation Type" drop-down button to select "AM" and set its parameters.

Carrier Waveform

Available AM carrier waves include sine (default), square, ramp, and Arb. Click or tap the "Basic Wave Type" drop-down button or press the corresponding front-panel waveform selection key to select the desired carrier waveform shape. Enter the Carrier Setting Interface and see [Continuous](#) to set the carrier parameters. The available frequency range varies for different carriers in the Modulation mode. For details, refer to [Table 6.1 Carrier Frequency Range \(Modulation Mode\)](#).

Modulating Waveform

The instrument accepts an internal or external signal as the modulation source. Click or tap the **Source** drop-down button to select "Internal" or "External".

- **Internal Source**

After "Internal" is selected, you can click or tap the **Shape** drop-down button to select the modulating waveform shape. Available shapes include:

- Sine
- Square with 50% duty cycle
- Triangle with 50% symmetry
- UpRamp with 100% symmetry
- DnRamp with 0% symmetry
- Noise - white gaussian noise
- Arb: When the "Shape" is set to Arb, you can click or tap the **Shape** input field to set the Arb type.

- **External Source**

After "External" is selected, **AM Freq** is grayed out and disabled. The instrument accepts an external modulation source applied to the front-panel **[Mod In]** connector. At this time, the amplitude of the modulated waveform is controlled by the ± 5 V signal level present on the connector.

**NOTE**

How to realize the intermodulation between two channels? The following example takes the output signal of CH2 as the AM modulating waveform.

1. Connect the CH2 output terminal to the front-panel **[Mod In]** connector of CH1 using the BNC-to-SMB cable.
2. Select CH1 and set the output mode to "Mod". Select the desired modulation type and set the corresponding parameters. Set the **Source** to "External".
3. Select CH2 and set the desired shape as well as the corresponding parameters.
4. Turn on the CH1 and CH2 outputs.

Modulation Frequency

After the internal modulation source is selected, click or tap the **AM Freq** input field and set the modulation frequency with the pop-up numeric keypad. The available range is from 2 mHz to 1 MHz, and the default is 100 Hz. The resolution is 1 mHz.

**TIP**

When an external modulation source is selected, this setting is grayed out and disabled.

Modulation Depth

Modulation depth is a percentage that represents the amplitude variation. Click or tap the **Depth** input field to set the modulation depth. AM depth ranges from 0% to 120% (limited by the amplitude). The default is 100%, and the resolution is 0.01%. When DSSC is off, $\text{Output Amplitude} = (1 + \text{Modulation Depth})/2 * \text{Carrier Amplitude}$; when DSSC is on, $\text{Output Amplitude} = \text{Modulation Depth} * \text{Carrier Amplitude}$.

When an external modulation source is selected, the AM modulation amplitude is also controlled by the ± 5 V signal level on the front-panel **[Mod In]** connector. For example, when DSSC is off, if the modulation depth is set to 100%, then the output will be at the maximum amplitude when the modulating signal is at +5 V. The output will be at the minimum amplitude when the modulating signal is at -5 V.

DSSC

DG6000 supports two forms of amplitude modulation, Normal and Double Sideband Suppressed Carrier (DSSC). In "normal" AM, the modulated wave consists of the carrier wave and two sidebands. Such a modulation is inefficient because the carrier wave carries no information. If this carrier is suppressed and the saved power is

distributed to the two sidebands, then such a process is called Double Sideband Suppressed Carrier (DSSC).

By default, the "DSSC" is off. Click or tap the **DSSC** on/off switch to turn on or off the DSSC function.

6.2 Frequency Modulation (FM)

In Frequency Modulation (FM), a modulated waveform consists of a carrier waveform and a modulating waveform. The frequency of the carrier waveform is varied by the instantaneous voltage of the modulating waveform. In the "Modulation Setting Interface" ([Figure 6.1](#)), click or tap the "Modulation Type" drop-down button to select "FM" and set its parameters.

Carrier Waveform

Available FM carrier waves include sine (default), square, ramp, and Arb. Click or tap the "Basic Wave Type" drop-down button or press the corresponding front-panel waveform selection key to select the desired carrier waveform shape. Enter the Carrier Setting Interface and see [Continuous](#) to set the carrier parameters. The available frequency range varies for different carriers in the Modulation mode. For details, refer to [Table 6.1 Carrier Frequency Range \(Modulation Mode\)](#).

Modulating Waveform

The instrument accepts an internal or external signal as the modulation source. Click or tap the **Source** drop-down button to select "Internal" or "External".

- **Internal Source**

After "Internal" is selected, you can click or tap the **Shape** drop-down button to select the modulating waveform shape. Available shapes include:

- Sine
- Square with 50% duty cycle
- Triangle with 50% symmetry
- UpRamp with 100% symmetry
- DnRamp with 0% symmetry
- Noise - white gaussian noise
- Arb: When the "Shape" is set to Arb, you can click or tap the **Shape** input field to set the Arb type.

- **External Source**

After "External" is selected, **FM Freq** is grayed out and disabled. The instrument accepts an external modulation source applied to the front-panel **[Mod In]**

connector. At this time, the FM frequency deviation is controlled by the ± 5 V signal level present on the connector.

Modulation Frequency

After the internal modulation source is selected, click or tap the **FM Freq** input field and set the modulation frequency with the pop-up numeric keypad. The available range is from 2 mHz to 1 MHz, and the default is 100 Hz. The resolution is 1 mHz.



TIP

When an external modulation source is selected, this setting is grayed out and disabled.

Frequency Deviation

It represents the peak variation in frequency of the modulated waveform from the carrier frequency. Click or tap the **Freq Dev** input field to set the frequency deviation. The minimum frequency deviation is 0 Hz.

- For FM, the frequency deviation must always be less than or equal to the carrier frequency minus 1 μ Hz.
- The frequency deviation plus the carrier frequency must be less than or equal to the selected carrier's maximum frequency.

When an external modulation source is selected, the frequency deviation is controlled by the ± 5 V signal level on the front-panel **[Mod In]** connector. For example, if the frequency deviation is set to 1 kHz, the +5 V signal level corresponds to a 1 kHz increase in frequency. Lower external signal levels produce less deviation and negative signal levels reduce the frequency below the carrier frequency.

6.3 Phase Modulation (PM)

In Phase Modulation (PM), a modulated waveform consists of a carrier waveform and a modulating waveform. The phase of the carrier waveform is varied by the instantaneous voltage of the modulating waveform. In the "Modulation Setting Interface" ([Figure 6.1](#)), click or tap the "Modulation Type" drop-down button to select "PM" and set its parameters.

Carrier Waveform

Available PM carrier waves include sine (default), square, ramp, and Arb. Click or tap the "Basic Wave Type" drop-down button or press the corresponding front-panel waveform selection key to select the desired carrier waveform shape and access the setup interface. To configure different carrier waveforms, please refer to [Continuous](#). The available frequency range varies for different carriers in the Modulation mode. For details, refer to [Table 6.1 Carrier Frequency Range \(Modulation Mode\)](#).

Modulating Waveform

The instrument accepts an internal or external signal as the modulation source. Click or tap the **Source** drop-down button to select "Internal" or "External".

- **Internal Source**

After "Internal" is selected, you can click or tap the **Shape** drop-down button to select the modulating waveform shape. Available shapes include:

- Sine
- Square with 50% duty cycle
- Triangle with 50% symmetry
- UpRamp with 100% symmetry
- DnRamp with 0% symmetry
- Noise - white gaussian noise
- Arb: When the "Shape" is set to Arb, you can click or tap the **Shape** input field to set the Arb type.

- **External Source**

After "External" is selected, **PM Freq** is grayed out and disabled. The instrument accepts an external modulation source applied to the front-panel **[Mod In]** connector. At this time, the PM phase deviation is controlled by the ± 5 V signal level present on the connector.

Modulation Frequency

After the internal modulation source is selected, click or tap the **PM Freq** input field and set the modulation frequency with the pop-up numeric keypad. The available range is from 2 mHz to 1 MHz, and the default is 100 Hz. The resolution is 1 mHz.

TIP

When an external modulation source is selected, this setting is grayed out and disabled.

Phase Deviation

The phase deviation represents the peak variation in phase of the modulated waveform from the carrier waveform. Click or tap the **PM Dev** input field to set the phase deviation. It ranges from 0° to 360° , and the default is 90° . The resolution is 0.01° .

When an external modulation source is selected, the phase deviation is controlled by the ± 5 V signal level on the front-panel **[Mod In]** connector. For example, if the phase deviation is set to 180° , the +5 V signal level corresponds to a 180° phase shift. Lower external signal levels produce less deviation.

6.4 Amplitude Shift Keying (ASK)

With Amplitude Shift Keying (ASK), you can configure the instrument to "shift" its output amplitude between two preset values (called the "carrier amplitude" and the "modulation amplitude"). In the "Modulation Setting Interface" ([Figure 6.1](#)), click or tap the "Modulation Type" drop-down button to select "ASK" and set its parameters.

Carrier Waveform

Available ASK carrier waves include sine (default), square, ramp, and Arb. Click or tap the "Basic Wave Type" drop-down button or press the corresponding front-panel waveform selection key to select the desired carrier waveform shape.

In the Carrier (Continuous) Setting Interface, when the output type is differential, click or tap the **DM Ampl** input field to set the carrier amplitude; when the output type is single-ended, click or tap the **Ampl/High** button or press the front-panel  key to set the parameter to "Ampl". Click or tap its input field and use the pop-up numeric keypad to set the carrier amplitude. For carrier amplitude setting methods and available range, please refer to [Continuous](#). The available frequency range varies for different carriers in the Modulation mode. For details, refer to [Table 6.1 Carrier Frequency Range \(Modulation Mode\)](#).

Modulation Source

The instrument accepts an internal or external signal as the modulation source. Click or tap the **Source** drop-down button to select "Internal" or "External".

- **Internal Source**

When "Internal" is selected, the instrument uses a square wave with 50% duty cycle as the ASK modulation source. At this time, the output amplitude "shifts" between "carrier amplitude" and "modulation amplitude". The shift rate is determined by "ASK Rate".

- **External Source**

When "External" is selected, the instrument accepts an external modulation signal from the specified port as the ASK modulation source. You can click or tap the **Port** drop-down button to select the input port.

- Front port: The instrument accepts an external modulation signal from the front-panel **[Mod In]** connector. The modulation rate is up to 100 kHz.
- Rear port: The instrument accepts an external modulation signal from the rear-panel **[AUX IN]** connector. The modulation rate is up to 10 MHz.

ASK Rate

ASK rate is the rate at which the output amplitude "shifts" between the carrier amplitude and modulation amplitude when an internal modulation source is used. Click or tap the **ASK Rate** input field and use the pop-up numeric keypad to set the rate. The available range is from 2 mHz to 1 MHz, and the default is 100 Hz. The resolution is 1 mHz.



TIP

When the external modulation source is selected, this setting is grayed out and disabled.

Modulation Amplitude

Click or tap the **ASK Ampl** input field and use the pop-up numeric keypad to set the modulation amplitude. The available range of modulation amplitude is consistent with the range of basic waveform amplitude and the default is 1 Vpp.

Polarity

Click or tap the **Polarity** drop-down button to select "Positive" or "Negative" to control the amplitude output. The default is "Positive".

- **Positive:** when the internal/external modulation signal is a logic low level, the carrier amplitude is output; when the signal is a logic high level, the modulation amplitude is output.
- **Negative:** when the internal/external modulation signal is a logic low level, the modulation amplitude is output; when the signal is a logic high level, the carrier amplitude is output.

6.5 Frequency Shift Keying (FSK)

With Frequency Shift Keying (FSK), you can configure the instrument to "shift" its output frequency between two preset values (called the "carrier frequency" and the "hop frequency"). In the "Modulation Setting Interface" (*Figure 6.1*), click or tap the "Modulation Type" drop-down button to select "FSK" and set its parameters.

Carrier Waveform

Available FSK carrier waves include sine (default), square, ramp, and Arb. Click or tap the "Basic Wave Type" drop-down button or press the corresponding front-panel waveform selection key to select the desired carrier waveform shape.

In the Carrier (Continuous) Setting Interface, click or tap the **Freq/Period** button or press the front-panel  to set the parameter to "Freq". Click or tap its input field and use the pop-up numeric keypad to set the carrier frequency. The available frequency range varies for different carriers in the Modulation mode. For details, refer to *Table 6.1 Carrier Frequency Range (Modulation Mode)*.

Modulation Source

The instrument accepts an internal or external signal as the modulation source. Click or tap the **Source** drop-down button to select "Internal" or "External".

- **Internal Source**

When "Internal" is selected, the instrument uses a square wave with 50% duty cycle as the FSK modulation source. At this time, the output frequency "shifts" between "carrier frequency" and "hop frequency". The shift rate is determined by "FSK Rate".

- **External Source**

When "External" is selected, the instrument accepts an external modulation signal from the specified port as the FSK modulation source. You can click or tap the **Port** drop-down button to select the input port.

- Front port: The instrument accepts an external modulation signal from the front-panel **[Mod In]** connector. The modulation rate is up to 100 kHz.
- Rear port: The instrument accepts an external modulation signal from the rear-panel **[AUX IN]** connector. The modulation rate is up to 10 MHz.

FSK Rate

FSK rate is the rate at which the output frequency "shifts" between the carrier frequency and the hop frequency when an internal modulation source is used. Click or tap the **FSK Rate** input field and use the pop-up numeric keypad to set the rate. The available range is from 2 mHz to 1 MHz, and the default is 100 Hz.

TIP

When the external modulation source is selected, this setting is grayed out and disabled.



Hop Frequency

Click or tap the **Hop Freq** input field and use the pop-up numeric keypad to set the hop frequency. The range of hop frequency is related to the instrument model and wave type. For details, refer to [Table 5.1 Range of Continuous Waveform Frequency](#).

Polarity

Click or tap the **Polarity** drop-down button to select "Positive" or "Negative" to control the frequency output. The default is "Positive".

- **Positive:** when the internal/external modulation signal is a logic low level, the carrier frequency is output; when the signal is a logic high level, the hop frequency is output.

- **Negative:** when the internal/external modulation signal is a logic low level, the hop frequency is output; when the signal is a logic high level, the carrier frequency is output.

6.6 Phase Shift Keying (PSK)

In Phase Shift Keying (PSK), you can configure the instrument to "shift" its output phase between two preset phase settings ("carrier phase" and "modulation phase"). In the "Modulation Setting Interface" ([Figure 6.1](#)), click or tap the "Modulation Type" drop-down button to select "PSK" and set its parameters.

Carrier Waveform

Available PSK carrier waves include sine (default), square, ramp, and Arb. Click or tap the "Basic Wave Type" drop-down button or press the corresponding front-panel waveform selection key to select the desired carrier waveform shape.

In the Carrier (Continuous) Setting Interface, click or tap the "Phase" input field and use the pop-up numeric keypad to set the starting phase. It ranges from -360° to 360° , and the default is 0° . The resolution is 0.01° . The available frequency range varies for different carriers in the Modulation mode. For details, refer to [Table 6.1 Carrier Frequency Range \(Modulation Mode\)](#).

Modulation Source

The instrument accepts an internal or external signal as the modulation source. Click or tap the **Source** drop-down button to select "Internal" or "External".

- **Internal Source**

When "Internal" is selected, the instrument uses a square wave with 50% duty cycle as the PSK modulation source. At this time, the output phase "shifts" between "carrier phase" and "modulation phase". The shift rate is determined by "PSK Rate".

- **External Source**

When "External" is selected, the instrument accepts an external modulation signal from the specified port as the PSK modulation source. You can click or tap the **Port** drop-down button to select the input port.

- Front port: The instrument accepts an external modulation signal from the front-panel **[Mod In]** connector. The modulation rate is up to 100 kHz.
- Rear port: The instrument accepts an external modulation signal from the rear-panel **[AUX IN]** connector. The modulation rate is up to 10 MHz.

PSK Rate

PSK rate is the rate at which the output phase "shifts" between the carrier phase and modulation phase when an internal modulation source is used. Click or tap the **PSK**

Rate input field and use the pop-up numeric keypad to set the rate. The available range is from 2 mHz to 1 MHz, and the default is 100 Hz. The resolution is 1 mHz.



TIP

When the external modulation source is selected, this setting is grayed out and disabled.

Modulation Phase

Click or tap the **Phase** input field and use the pop-up numeric keypad to set the modulation phase. It ranges from 0° to 360°, and the default is 180°. The resolution is 0.01°.

Polarity

Click or tap the **Polarity** drop-down button to select "Positive" or "Negative" to control the phase output. The default is "Positive".

- **Positive:** when the internal/external modulation signal is a logic low level, the carrier phase is output; when the signal is a logic high level, the modulation phase is output.
- **Negative:** when the internal/external modulation signal is a logic low level, the modulation phase is output; when the signal is a logic high level, the carrier phase is output.

6.7 Pulse Width Modulation (PWM)

For Pulse Width Modulation (PWM), the pulse width of the output signal is varied by the instantaneous voltage of the modulating waveform. The amount by which the pulse width varies is called the width deviation.



TIP

To select the PWM function, first click or tap the "Basic Wave Type" drop-down button to select "Pulse" and then set the "Output Mode" to "Mod". The modulation type will be set to "PWM" automatically. Refer to the following section to set the other modulation parameters.

Carrier Waveform

PWM is only available for the Pulse waveform. Click or tap the "Basic Wave Type" drop-down button to select "Pulse" or press the front-panel  key to set the carrier waveform to Pulse. For pulse width/duty cycle setting, refer to *To Output Pulse*.

Modulation Source

The instrument accepts an internal or external signal as the modulation source. Click or tap the **Source** drop-down button to select "Internal" or "External".

- **Internal Source**

After "Internal" is selected, you can click or tap the **Shape** drop-down button to select the modulating waveform shape. Available shapes include:

- Sine
 - Square with 50% duty cycle
 - Triangle with 50% symmetry
 - UpRamp with 100% symmetry
 - DnRamp with 0% symmetry
 - Noise - white gaussian noise
 - Arb: When the "Shape" is set to Arb, you can click or tap the **Shape** input field to set the Arb type.
- **External Source**

After "External" is selected, **PWM Freq** is grayed out and disabled. The instrument accepts an external modulation source applied to the front-panel **[Mod In]** connector. At this time, the PWM width/duty cycle deviation is controlled by the ± 5 V signal level present on the connector.

Modulation Frequency

After the internal modulation source is selected, click or tap the **PWM Freq** input field and set the modulation frequency with the pop-up numeric keypad. The available range is from 2 mHz to 1 MHz, and the default is 100 Hz.

TIP

When an external modulation source is selected, this setting is disabled.

Width Deviation/Duty Cycle Deviation

PWM deviation represents the variation of the modulated waveform pulse width relative to the original pulse width. You can use time (width deviation) or duty cycle (duty cycle deviation) to set the PWM deviation. This setting is subject to the *Set the Pulse Width/Duty Cycle* setting in Carrier (Pulse) setting. For example, if "Width" is selected for *Set the Pulse Width/Duty Cycle* of the Pulse setting, then the PWM deviation setting is automatically set to "Width Dev".

- **Width Deviation**

Width deviation represents the amount by which the pulse width of the modulated waveform varies from the original pulse width. The unit is s. For example, if you specify a pulse width as 10 s and width deviation as 5 s, the pulse width of the modulated waveform varies from 5 s to 15 s under the control of the modulating signal.

Click or tap the **Duty Dev/Width Dev** button to set the parameter to "Width Dev". "Width Dev" is now highlighted. Click or tap its input field to set the width deviation. The range of the width deviation is limited by the pulse width, rising edge time, and falling edge time of the pulse waveform.

- **Duty Cycle Deviation**

Duty cycle deviation represents the amount by which the pulse width of the modulated waveform varies from the original pulse width. The unit is the percentage of the waveform period. For example, if you specify a pulse duty cycle as 10% and duty cycle deviation as 5%, the duty cycle of the modulated waveform varies from 5% to 15% under the control of the modulating signal.

Click or tap the **Duty Dev/Width Dev** button to set the parameter to "Duty Dev". "Duty Dev" is now highlighted. Click or tap its input field to set the duty cycle deviation. The duty cycle deviation ranges from 0% to 49.99%, and is limited by the pulse width, duty cycle, and edge time of the pulse waveform.

When an external modulation source is selected, the width deviation (or duty cycle deviation) is controlled by the ± 5 V signal level on the front-panel **[Mod In]** connector. For example, if the width deviation is set to 10 s, the +5 V signal level corresponds to a 10 s deviation.

6.8 SUM Modulation

When the waveform summing function is enabled, you can add a specified waveform to the carrier. In the "Modulation Setting Interface" ([Figure 6.1](#)), click or tap the "Modulation Type" drop-down button to select "SUM" and set its parameters.

Carrier Waveform

Available carrier waves include sine (default), square, ramp, and Arb. Click or tap the "Basic Wave Type" drop-down button or press the corresponding front-panel waveform selection key to select the desired carrier waveform shape. Enter the Carrier Setting Interface and see [Continuous](#) to set the carrier parameters. The available frequency range varies for different carriers in the Modulation mode. For details, refer to [Table 6.1 Carrier Frequency Range \(Modulation Mode\)](#).

Sum Waveform

Click or tap the **Waveform** drop-down button to select the waveform to be added to the current waveform. Available waveform shapes include:

- Sine
- Square with 50% duty cycle
- Triangle with 50% symmetry
- UpRamp with 100% symmetry

- DnRamp with 0% symmetry
- Noise - white gaussian noise
- Arb: When the "Shape" is set to Arb, you can click or tap the **Waveform** input field to set the Arb type.

Sum Frequency

It sets the frequency of the waveform to be added to the current continuous waveform. Click or tap the **SUM Freq** input field and use the pop-up virtual keypad to set the frequency. The range of the Sum frequency is from 2 mHz to 1 MHz.

Sum Ratio

It sets the ratio of the amplitude of the waveform to be added relative to the amplitude of the current waveform. Output Amplitude of Summed Waveform = Carrier Amplitude x (1 + Sum Ratio). Click or tap the **SUM Ratio** input field and use the pop-up virtual keypad to set the ratio. The available range is from 0% to 100%, and the default is 50%. The upper limit of the sum ratio is limited by the maximum peak of the current output waveform.

7 Sweep

In frequency sweep mode, the instrument moves from the start frequency to the stop frequency within a specified sweep time. You can sweep up or down in frequency, with linear, logarithmic, or step sweep types. It allows you to set the "Mark" frequency, start/stop hold time, and return time. It provides trigger sources including internal, external, and manual sources. You can sweep sine, square, ramp, and Arb.

Click or tap the "Output Mode" drop-down button to select "Sweep" and access the interface as shown in the figure below. You can click or tap one of the tabs at the bottom to access the Continuous Setting Interface, Sweep Setting Interface, or Channel Setup Interface. For Continuous Setting Interface and Channel Setup Interface, please refer to *Continuous* and *Channel Setup* respectively. This chapter only describes the sweep settings.

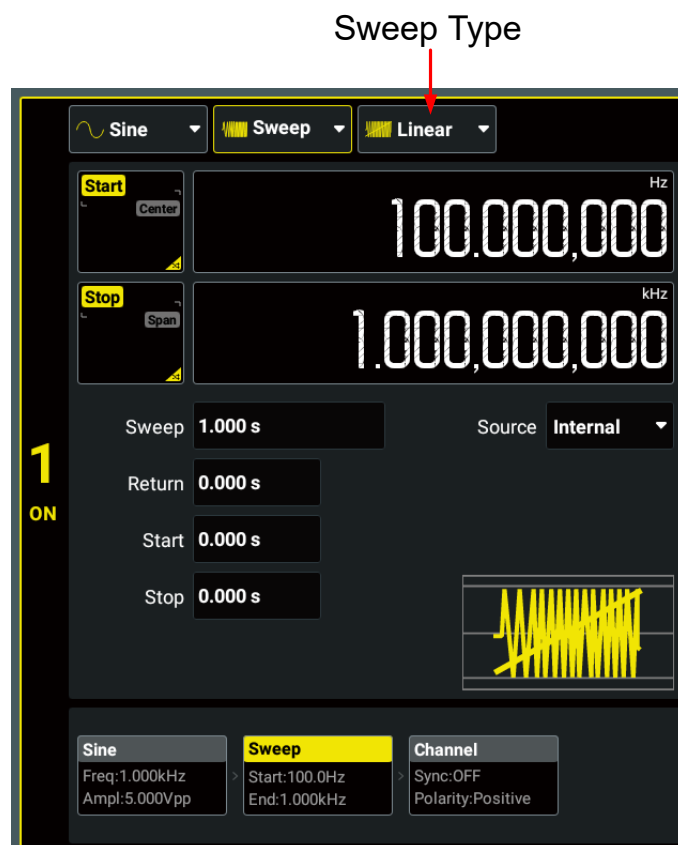

Figure 7.1 Sweep Setting Interface

7.1 Sweep Type

This instrument provides three sweep types: Linear, Log, and Step. The default is Linear. Click or tap the "Sweep Type" drop-down button to select "Linear", "Log", or "Step".

Linear Sweep

The instrument varies the output frequency linearly during the sweep, changing the output frequency by a constant number of Hz per second. It is characterized by "Start Frequency", "Stop Frequency", and "Sweep Time".

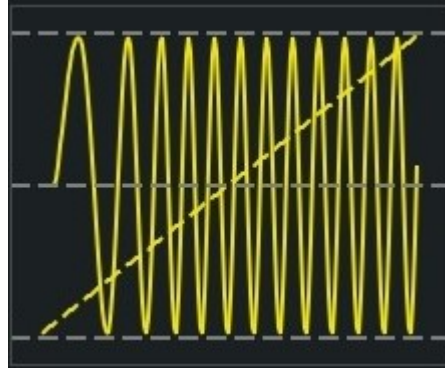

Figure 7.2 Linear Sweep

Logarithmic Sweep

The instrument varies the output frequency logarithmically during the sweep, changing the frequency by a constant number of octaves. It is characterized by "Start Frequency", "Stop Frequency", and "Sweep Time".

Define the start frequency, stop frequency, sweep time as F_{start} , F_{stop} , and T_{sweep} . The function of logarithmic sweep is $F = P^T$; wherein, P and T can be expressed in the following equations:

$$P = 10^{\lg(F_{stop}/F_{start})/T_{sweep}}$$

$$T = t + \lg(F_{start})/\lg(P)$$

In the equations above, t is the duration time after the sweep starts, ranging from 0 to T_{sweep} ; F is the current instantaneous frequency.

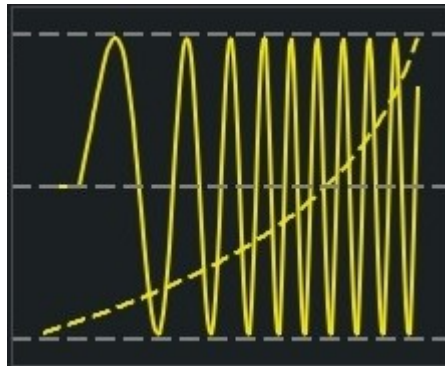

Figure 7.3 Logarithmic Sweep

Step Sweep

The instrument "steps" through a list of frequencies during the sweep. The period that the output signal dwells on each frequency is determined by "Sweep Time" and "Step Number".

When the sweep type is set to "Step", click or tap the **Step Num** input field to set the number of steps. It ranges from 2 (default) to 1024.

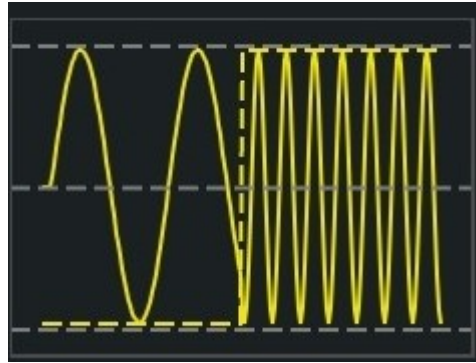

Figure 7.4 Step Sweep

7.2 Start Frequency and Stop Frequency

The start frequency and stop frequency set the sweep's upper and lower frequency bounds. The sweep begins at the start frequency, sweeps to the stop frequency, and then resets back to the start frequency.

- To sweep up in frequency, set the start frequency less than the stop frequency.
- To sweep down in frequency, set the opposite relationship.
- To sweep in a fixed frequency, set the same start frequency and stop frequency.

After enabling the sweep mode, click or tap the **Start/Center** button to set the parameter to "Start". "Start" is now highlighted. This operation also toggles the parameter of the **Stop/Span** button to "Stop". Click or tap the corresponding input field and use the pop-up numeric keypad to set the start frequency and stop frequency. By default, the start frequency is 100 Hz and the stop frequency is 1 kHz. The range of the start/stop frequency is related to the wave type.

Table 7.1 Sweep Start/Stop Frequency Range

Waveform	Start/Stop Frequency Range
Sine	1 μ Hz to 350 MHz
Square	1 μ Hz to 120 MHz

Waveform	Start/Stop Frequency Range
Ramp	1 μ Hz to 2.5 MHz
Arb	1 μ Hz to 100 MHz

After the start/stop frequency is modified, the instrument will sweep from the specified start frequency again.

7.3 Center Frequency and Frequency Span

You can also set the sweep frequency boundaries of the sweep using a center frequency and frequency span.

- Center Frequency = (Start Frequency + Stop Frequency)/2
- Frequency Span = Stop Frequency - Start Frequency

After enabling the sweep mode, click or tap the **Start/Center** button to set the parameter to "Center". "Center" is now highlighted. This operation also toggles the parameter of the **Stop/Span** button to "Span". Click or tap the corresponding input field and use the pop-up numeric keypad to set the center frequency or frequency span. By default, the center frequency is 550 Hz and the frequency span is 900 Hz. The ranges of center frequency and frequency span vary for different waveforms. Also, they are limited to each other.

The range of frequency span is affected by the center frequency. Define the upper limit of the start/stop frequency as F_{\max} and the lower limit of the start/stop frequency as F_{\min} ([Table 7.1 Sweep Start/Stop Frequency Range](#)). $F_m = (F_{\max} - F_{\min})/2$.

- When Center Frequency $\leq F_m$, the range of the Frequency Span is $\pm 2 \times (\text{Center Frequency} - F_{\min})$.
- When Center Frequency $> F_m$, the range of the Frequency Span is $\pm 2 \times (F_{\max} - \text{Center Frequency})$.

Take sine wave as an example. F_{\min} is 1 μ Hz, F_{\max} is 350 MHz, and F_m is about 175 MHz. If the center frequency is 100 MHz, the frequency span range is $\pm 2 \times (100 \text{ MHz} - 1 \mu\text{Hz}) = \pm 200 \text{ MHz}$; if the center frequency is 300 MHz, the frequency span range is $\pm 2 \times (350 \text{ MHz} - 300 \text{ MHz}) = \pm 100 \text{ MHz}$.



TIP

To sweep up in frequency, set a positive frequency span; to sweep down, set a negative frequency span.

7.4 Sweep Time

Sweep time specifies the time required to sweep from the start frequency to the stop frequency, as shown in the figure below.

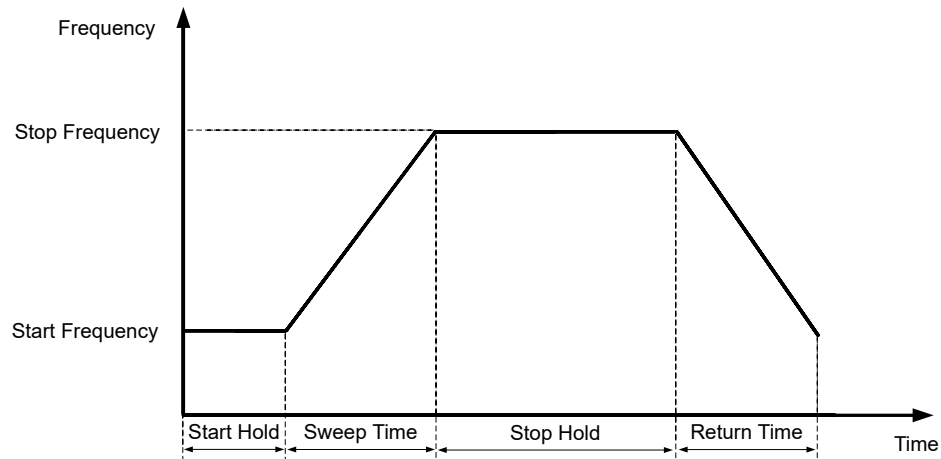

Figure 7.5 Sweep

Click or tap the **Sweep** input field and use the pop-up numeric keypad to set the sweep time. The default sweep time is 1 s and the resolution is 1 ms. The sweep time ranges from 1 ms to 250,000 s. The sweep time is related to the sweep type, trigger source, start hold time, return time, and stop hold time. $T_p = \text{Start Hold Time} + \text{Sweep Time} + \text{Stop Hold Time} + \text{Return Time}$:

- **Linear Sweep:**
 - Internal trigger: $T_p + 1 \text{ ms} \leq 8,000 \text{ s}$
 - Manual trigger/external trigger: $T_p \leq 250,000 \text{ s}$
- **Log Sweep/Step Sweep:** $T_p \leq 500 \text{ s}$

After the sweep time is modified, the instrument will sweep from the specified "Start Frequency" again.

7.5 Start/Stop Hold Time

Start hold time specifies the time for the sweep to remain at the "Start Frequency" (*Figure 7.5*). After the start hold time expires, the generator continues to sweep at varied frequencies according to the current sweep type.

Stop hold time specifies the time for the sweep to remain at the "Stop Frequency" after the generator sweeps from the "Start Frequency" to the "Stop Frequency".

You can click or tap the **Start/Stop** input field and use the pop-up numeric keypad to set the start/stop hold time. The default start/stop hold time is 0 s and the resolution

is 1 ms. The time ranges from 0 s to 3600 s and is related to the sweep type, trigger source, return time, and sweep time. $T_p = \text{Start Hold Time} + \text{Sweep Time} + \text{Stop Hold Time} + \text{Return Time}$:

- **Linear Sweep:**
 - Internal trigger: $T_p + 1 \text{ ms} \leq 8,000 \text{ s}$
 - Manual trigger/external trigger: $T_p \leq 250,000 \text{ s}$
- **Log Sweep/Step Sweep:** $T_p \leq 500 \text{ s}$

After the start/stop hold time is modified, the instrument will sweep from the specified start frequency again.

7.6 Return Time

Return time specifies the time to return from the "Stop Frequency" to the "Start Frequency" (*Figure 7.5*).

Click or tap the **Return** input field and use the pop-up numeric keypad to set the return time. The default return time is 0 s and the resolution is 1 ms. The time ranges from 0 s to 3600 s and is related to the sweep type, trigger source, start hold time, stop hold time, and sweep time. $T_p = \text{Start Hold Time} + \text{Sweep Time} + \text{Stop Hold Time} + \text{Return Time}$:

- **Linear Sweep:**
 - Internal trigger: $T_p + 1 \text{ ms} \leq 8,000 \text{ s}$
 - Manual trigger/external trigger: $T_p \leq 250,000 \text{ s}$
- **Log Sweep/Step Sweep:** $T_p \leq 500 \text{ s}$

After the return time is modified, the instrument will sweep from the specified "Start Frequency" again.

7.7 Sweep Trigger Source

The sweep trigger source can be internal trigger, external leading edge, external trailing edge, or manual trigger. The instrument outputs a single sweep when a trigger signal is received and waits for the next trigger. Click or tap the **Source** drop-down button and select the trigger source. The default is "Internal".

- **Internal:** The instrument outputs a continuous sweep. The trigger period is determined by the specified sweep time, return time, start hold time, and stop hold time. Note that when the internal trigger source is selected, $\text{Trigger Period} = 1 \text{ ms} + \text{Start Hold Time} + \text{Sweep Time} + \text{Stop Hold Time} + \text{Return Time}$.

- **Ext Leading:** The instrument receives the trigger signal from the rear-panel **[AUX IN]** connector. A sweep is generated each time a TTL pulse with leading edge is received. Note that when the external trigger source is selected, External Trigger Signal Period $\geq 1 \text{ ms} + \text{Start Hold Time} + \text{Sweep Time} + \text{Stop Hold Time} + \text{Return Time}$.
- **Ext Trailing:** The instrument receives the trigger signal from the rear-panel **[AUX IN]** connector. A sweep is generated each time a TTL pulse with trailing edge is received. Note that when the external trigger source is selected, External Trigger Signal Period $\geq 1 \text{ ms} + \text{Start Hold Time} + \text{Sweep Time} + \text{Stop Hold Time} + \text{Return Time}$.
- **Manual:** When "Manual" is selected, press the front-panel  key to initiate a sweep output immediately.



TIP

When "Internal" or "Manual" is selected, the generator outputs a TTL-compatible signal with the specified edge via the front-panel **[Sync Out]** connector. Please refer to *Trigger Output Setup*.

7.8 Mark Frequency

For frequency sweeps, the sync signal outputs a high level at the beginning of the sweep. If the sync mode is set to "Normal", the sync signal goes low at the end of the sweep. If the sync mode is set to "Mark", the sync signal goes low at the specified marker frequency.

After enabling the Sweep function, click or tap the Channel tab at the bottom to enter the Channel Setup Interface. Click or tap the **Sync Mode** drop-down button to set the sync mode of the sweep waveform to "Mark" to enable the function. You can click or tap the **Mark Freq** to set the mark frequency. Mark frequency is limited by the sweep "Start Frequency" and "Stop Frequency".



NOTE

For step sweep (the sweep points determined by the start frequency, stop frequency, and step number respectively are $f_1, f_2, \dots, f_n, f_{n+1}, \dots$), if the mark frequency setting is one of the sweep point values, the sync signal is a TTL high level at the beginning of the sweep and a low level at the mark frequency. If the mark frequency is not equal to any of the sweep point values, the sync signal becomes a low level at the sweep point which is less than and closest to the mark frequency when sweeping from high frequency to low frequency or at the sweep point which is greater than and closest to the mark frequency when sweeping from low frequency to high frequency. Take sweeping from high frequency to low frequency as an example. If the mark frequency is set to 1 MHz and the sweep points are 0.99 MHz and 1.01 MHz, then 0.99 MHz will be selected as the mark frequency to be applied to the digital system.

8 Burst

DG6000 can output a waveform for a specified number of cycles, called a burst. You can use Sine, Square, Ramp, Pulse, Arb, and Noise (only available for "Gated" Burst) to generate burst waveforms.

Click or tap the "Output Mode" drop-down button to select "Burst" to enter the Burst Setting Interface, as shown in the figure below. You can click or tap one of the tabs at the bottom to enter the Continuous Setting Interface, Burst Setting Interface, or Channel Setup Interface. For Continuous Setting Interface and Channel Setup Interface, please refer to *Continuous* and *Channel Setup* respectively. This chapter only describes the burst settings.



TIP

The Burst mode cannot be enabled when the fundamental frequency is less than or equal to 125 μ Hz.

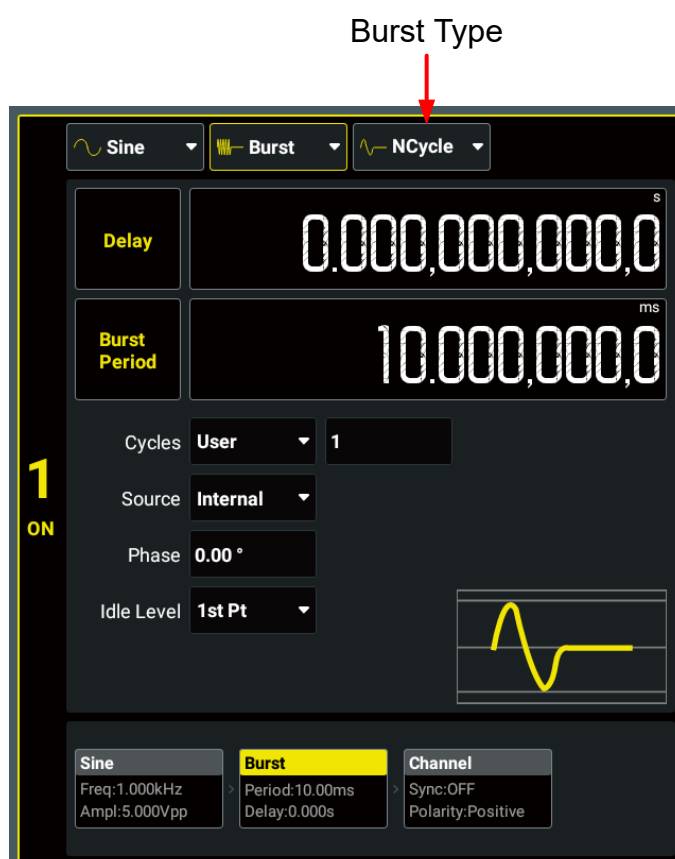

Figure 8.1 Burst Setting Interface

The following table shows the range of the frequency for different carriers in the Burst mode.

Table 8.1 Carrier Frequency Range (Burst Mode)

Waveform	Carrier Frequency Range
Sine	126 μ Hz to 350 MHz
Square	126 μ Hz to 120 MHz
Ramp	126 μ Hz to 2.5 MHz
Pulse	126 μ Hz to 120 MHz
Arb	126 μ Hz to 100 MHz

8.1 Burst Type

DG6000 can output two types of bursts: N-Cycle Burst (default) and Gated Burst. In the Burst Setting Interface (*Figure 8.1*), click or tap the "Burst Type" drop-down button to select "N-Cycle" or "Gated". The table below illustrates the trigger sources and waveform parameters available for the two burst types.

Burst Type		Trigger Source	Burst Parameters
N-Cycle Burst	User-defined	Internal/External/Manual Trigger	Delay, Burst Period, Source, Trigger Output (only available for manual trigger and internal trigger), Phase, Cycles, Idle Level
	Infinite	External/Manual Trigger	Delay, Source, Trigger Output (only available for manual trigger), Phase, Cycles, Idle Level
Gated Burst		External Trigger	Starting Phase, Polarity, Idle Level

N-Cycle Burst

In N-Cycle Burst mode, the instrument outputs a waveform for a specified number of cycles (burst count) each time trigger is received. You can also set the burst count to "Infinite". Available waveform functions for N-Cycle burst include Sine, Square, Ramp, Pulse, and Arb. Click or tap the **Cycles** drop-down button to set the burst count.

- **Infinite:** Infinite Burst sets the burst count to "infinite". The instrument outputs a continuous waveform when a trigger signal is received.
- **User:** Click or tap the **Cycles** input field and use the pop-up numeric keypad to set the burst count. It ranges from 1 (default) to 1 M. If you change the burst count, the instrument automatically increases the burst period to accommodate the burst count (but the waveform frequency will not be changed). When the

trigger source is set to internal trigger, the maximum burst count that can be set is affected by the signal frequency.

Gated Burst

In Gated Burst mode, the generator controls the waveform output based on the external signal level from the rear-panel **[AUX IN]** connector. Available waveform functions for Gated burst include Sine, Square, Ramp, Pulse, Noise, and Arb. When the gate signal is "true", the instrument outputs a continuous waveform. When the gate signal is "false", the instrument first stops the current waveform output and remains at the voltage level corresponding to the "Idle Level" setting.

8.2 Burst Delay

Burst delay, which is only available for N-Cycle Burst mode, is the duration from the time when the instrument receives the trigger signal to the time when it starts to output the burst signal.

Click or tap the **Delay** input field and use the pop-up numeric keypad to set the delay. The default delay is 0 s and the resolution is 0.1 ns. The range of burst delay is related to the trigger source:

- Manual/external trigger: 0 s to 85 s.
- Internal trigger: 0 s to $(T_{burst} - \lceil T_{wave} \times N_{cycle} \div 6.4 \text{ ns} \rceil \times 6.4 \text{ ns} - 4 \mu\text{s})^{[1]}$, and less than or equal to 85 s.
 - T_{burst} : burst period
 - T_{wave} : period of basic waveform (e.g. Sine and Square)
 - N_{cycle} : burst count

NOTE

[1]: $\lceil x \rceil$ indicates that x is rounded up.



8.3 Burst Phase

In Burst mode, the phase of the basic waveform is no longer in effect. The phase characteristics are determined by the burst phase. When the burst type is set to "Ncycle", click or tap the **Phase** input field to set the burst phase. When the burst type is set to "Gated", click or tap the **Start Phase** input field to set the phase. It ranges from -360° to 360° , and the default is 0° . The resolution is 0.01° .

- For Sine, Square, Pulse, and Ramp, 0° is the point at which the waveform crosses 0 V (or DC offset) in a positive-going direction.

- Burst phase setting is not available for noise.
- For arbitrary waveforms, 0° is the first waveform point.

**TIP**

In Burst mode, the phase of the basic waveform is fixed to 0° and cannot be modified.

8.4 Burst Period

Burst period is only available for internally triggered N-Cycle burst mode (user-defined burst count). Burst period is defined as the time from the start of a burst to the time when the next burst starts.

Click or tap the **Burst Period** input field and use the pop-up numeric keypad to set the period. It ranges from 4 μs to 8 ks and the default is 10 ms. The resolution is 0.1 ns.

- $\text{Burst Period} \geq \lceil (\text{Burst Count} \times \text{Waveform Period}) \div 6.4 \text{ ns} \rceil \times 6.4 \text{ ns} + 4 \mu\text{s}^{[1]}$
- If the burst period is too short, the generator will increase it automatically to allow the output of the specified number of cycles.

**NOTE**

[1]: [x] indicates that x is rounded up.

8.5 Burst Trigger Source

Available trigger sources for bursts include internal trigger, external leading edge, external trailing edge, and manual trigger. Click or tap the **Source** drop-down button and select the trigger source. The default is "Internal".

- **Internal:** Internal trigger is only available for N-Cycle Burst with user-defined burst count. When internal trigger is selected, the instrument outputs a burst of the specified cycles. The rate at which the burst is generated is determined by *Burst Period*. After completing the specified number of cycles, the instrument outputs the idle level and waits for the next trigger event.
- **Ext Leading:** When external leading edge is selected, the instrument receives the trigger signal from the rear-panel **[AUX IN]** connector. A burst is generated each time a TTL pulse with leading edge is received.
- **Ext Trailing:** When external trailing edge is selected, the instrument receives the trigger signal from the rear-panel **[AUX IN]** connector. A burst is generated each time a TTL pulse with trailing edge is received.

- **Manual:** Manual trigger is only available for N-Cycle Burst mode. When manual trigger is selected, press the front-panel **Trigger** key to initiate a burst output immediately. If the output of the corresponding channel is not enabled, the trigger will be ignored.

**TIP**

When "Internal" or "Manual" is selected, the generator outputs a TTL-compatible signal with the specified edge via the front-panel **[Sync Out]** connector. Please refer to *Trigger Output Setup*.

8.6 Gated Polarity

Gated polarity is only available for Gated Burst mode. It enables the instrument to output burst signals at a high level or low level. The gate signal is applied to the rear-panel **[AUX IN]** connector.

In the Burst Setting Interface, click or tap the "Burst Type" drop-down button to select "Gated" and enter the Gated Burst Setting Interface. Click or tap the **Polarity** drop-down button to select "Positive" or "Negative". The default is "Positive".

- **Positive:** When the gate signal is a high level, the instrument outputs a continuous waveform. When the gate signal is a low level, the instrument first stops the waveform output of the current period and remains at the voltage level set in the "Idle Level".
- **Negative:** When the gate signal is a low level, the instrument outputs a continuous waveform. When the gate signal is a high level, the instrument stops the current output and remains at the voltage level set in the "Idle Level".

8.7 Idle Level

In Burst mode, the output will not be turned off when there is no burst output but will remain at a specified voltage level, which is called the idle level. In N-Cycle Burst mode, the generator outputs a carrier waveform with a specified number of cycles and then continues to output the idle level until a burst period is complete, as shown in the figure below. In Gated Burst mode, the instrument will output the idle level when the gate signal is "false".

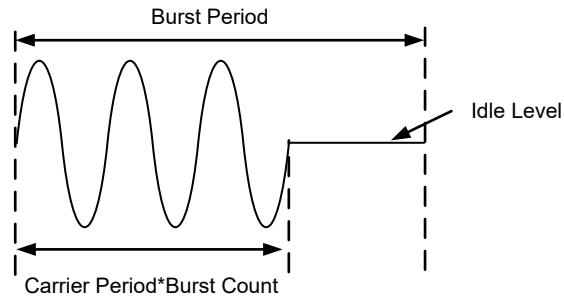

After enabling the Burst function, in Burst Setting Interface, click or tap the **Idle Level** drop-down button to select the idle level.

- **1st Pt:** Select the level at the first point of the carrier waveform as the idle level. It is not available for Square and Pulse.
- **Top:** Select the level at the top of the carrier waveform as the idle level.
- **Center:** Select the level at the center of the carrier waveform as the idle level.
- **Bottom:** Select the level at the bottom of the carrier waveform as the idle level.
- **User:** Select the specified position as the idle level. When "User" is selected, click or tap the **Idle Level** input field and use the pop-up numeric keypad to set the idle level. It ranges from 0 to 65,535, and the default is 0.



TIP

When the noise is the carrier waveform, the idle level is fixed to 32768 and cannot be modified.

9 Advanced Mode

DG6000 provides seven advanced waveform output types: Arb, Sequence, PRBS, Multi-pulse, Multi-tone, Pattern, and IQ.

Click or tap the "Output Mode" drop-down button to select "Advanced" and access the Advanced Waveform Setting Interface, as shown in the figure below. You can click or tap one of the tabs at the bottom to access the Advanced Waveform Setting Interface or Channel Setup Interface. For Channel Setup Interface, please refer to [Channel Setup](#). This chapter only describes the advanced waveform settings.

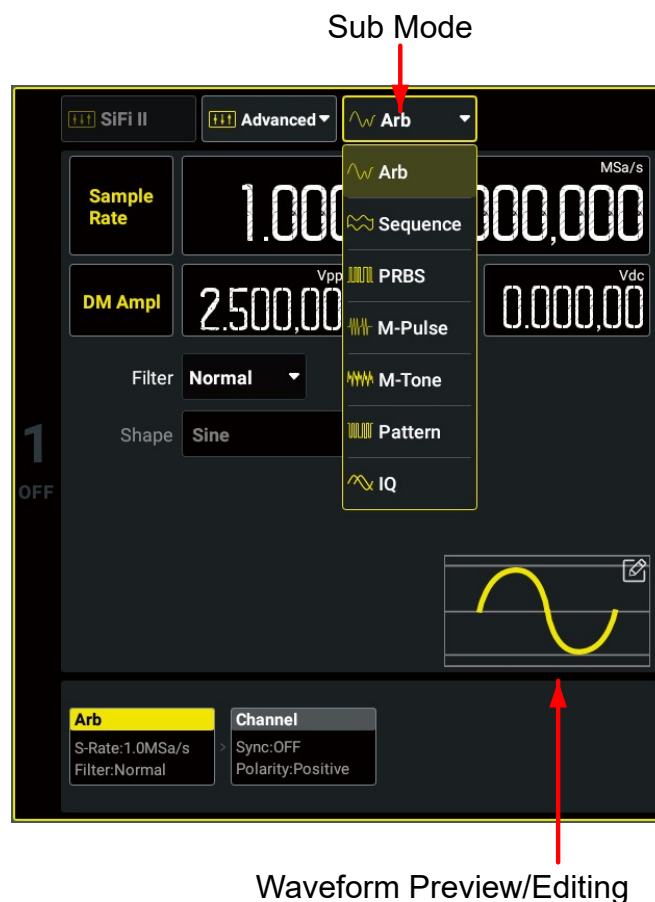

Figure 9.1 Advanced Waveform Setting Interface

9.1 Arb

DG6000 supports Arb output in both Continuous mode and Advanced mode. Based on the SiFi technology, DG6000 can output the arbitrary waveforms point by point according to the specified sample rate without losing any important points in the Advanced mode. For the Arb output in the Continuous Mode, refer to [To Output Arbitrary Waveforms](#).

In the Advanced Waveform Setting Interface, click or tap the "Sub Mode" drop-down button to select "Arb" to enter the Arb Setting Interface in the Advanced mode, as shown in the figure below.

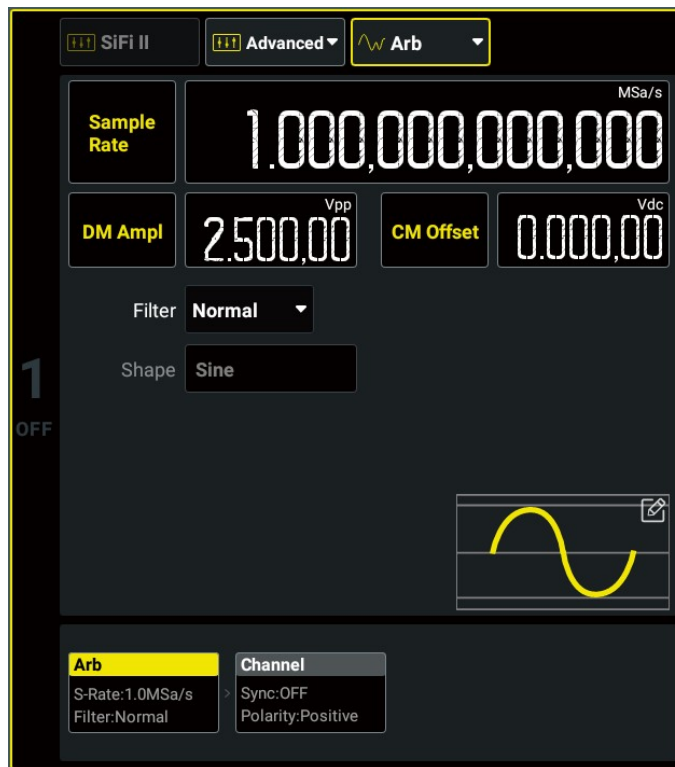

Figure 9.2 Arb Setting Interface (Advanced Mode)

Select the Data Source

In the Arb Setting Interface, click or tap the "Waveform Preview/Editing" area and select **Built In Wforms** or **Stored Wforms** in the displayed menu.

- Built-in waveforms: stored in the instrument's internal non-volatile memory, containing 11 types of waveforms: **Basic**, **Common**, **Engine**, **Seg Mod**, **Bioelect**, **Medical**, **Standard**, **Maths**, **Trigonome**, **Anti Trigonome**, and **Window Function**. Basic waveforms includes Sine, Square, Ramp, and Noise. For details about other built-in waveforms, refer to [Table 5.7 Built-in Waveforms](#)
- Stored waveforms: Arb files (*.arb/*.csv/*.txt) stored in the instrument's internal memory (C disk) or in the external memory (D disk). After "Stored Wforms" is selected, select the Arb file that you want to load and then click or tap **Load**. After loading, the data in the current volatile memory space will change. For descriptions of the three Arb file formats, refer to [To Output Arbitrary Waveforms](#).

NOTE

- When built-in waveforms are selected, the waveform length is fixed to 16,384 pts. When stored waveforms are selected, for *.arb files, the available length is from 32 pts to 128



Mpts (256 Mpts optional) in single-ended output type and 32 pts to 256 Mpts (512 Mpts optional) in differential output type. For *.txt files, the available length is from 32 pts to 8 Mpts. For *.csv files, the available length is from 32 pts to 1 Mpts.

- DG6000 does not support loading Arb files with file headers. It is recommended to use Ultra Station 00.02.01.00.01 or later to generate Arb waveforms and untick the "Save File With Header" box or select the DG6000 format when saving the file.

Set the Filter Mode

Click or tap the **Filter** drop-down button to select the filter mode.

- **Normal:** It has wide and flat frequency response as well as short edge time, but the step response produces a large overshoot.
- **Step:** It has more ideal step response, narrow bandwidth, longer rise/fall time, and longer edge time.
- **Edge:** It allows you to define the edge time to create bursts with arbitrary edge time. When "Edge" is selected, you can click or tap the **Filter** input field to set the edge time. When the sample rate is less than 400 MSa/s, the range is from 2 ns to $0.8 \cdot (1/\text{Sample Rate})$ and cannot exceed 1 μ s. When the sample rate is greater than or equal to 400 MSa/s, it is fixed to $0.8 \cdot (1/\text{Sample Rate})$. The resolution of the edge time is 100 ps.
- **Interpolation:** It guarantees the output of signals with no distortion at all.

Set the Waveform Parameters

Click or tap the **Sample Rate** input field to set the sample rate for the Arb waveform. The available range is from 1 μ Sa/s to 1.25 GSa/s. The output frequency is automatically calculated according to the number of waveform points: Output Frequency = Sample Rate/Waveform Points.

For other waveform parameters, refer to *Continuous*.

9.2 Sequence

A sequence is a combination of multiple individual waveforms in order. In Sequence mode, you can self-define the sequence and save the edited sequence to internal memory or external storage device (*.seq format).

In the Advanced Waveform Setting Interface, click or tap the "Sub Mode" drop-down button to select "Sequence" to enter the Sequence Setting Interface, as shown in the figure below.

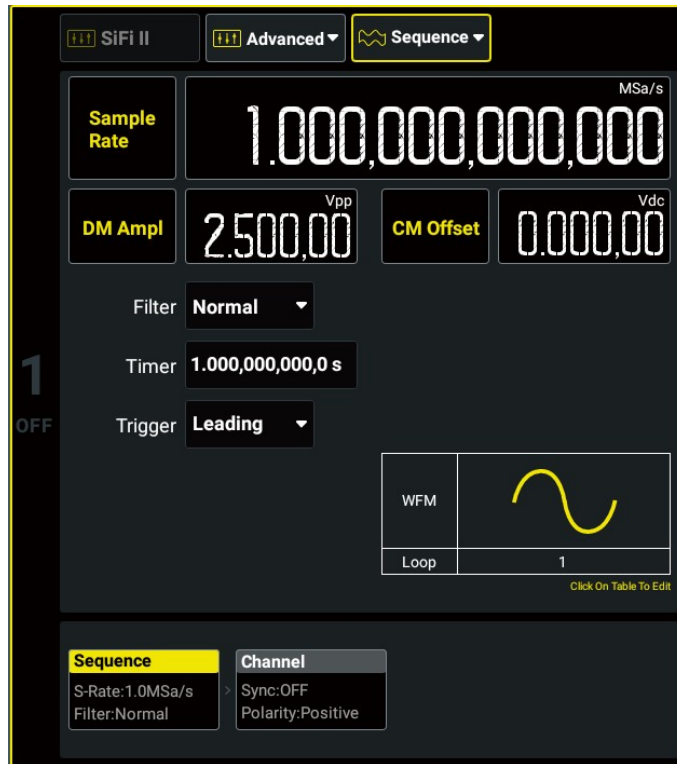

Figure 9.3 Sequence Setting Interface

9.2.1 New Sequence

In the sequence editing interface as shown in *Figure 9.3*, click or tap the "Waveform Preview/Editing" area to open the sequence editing table, as shown in the figure below.

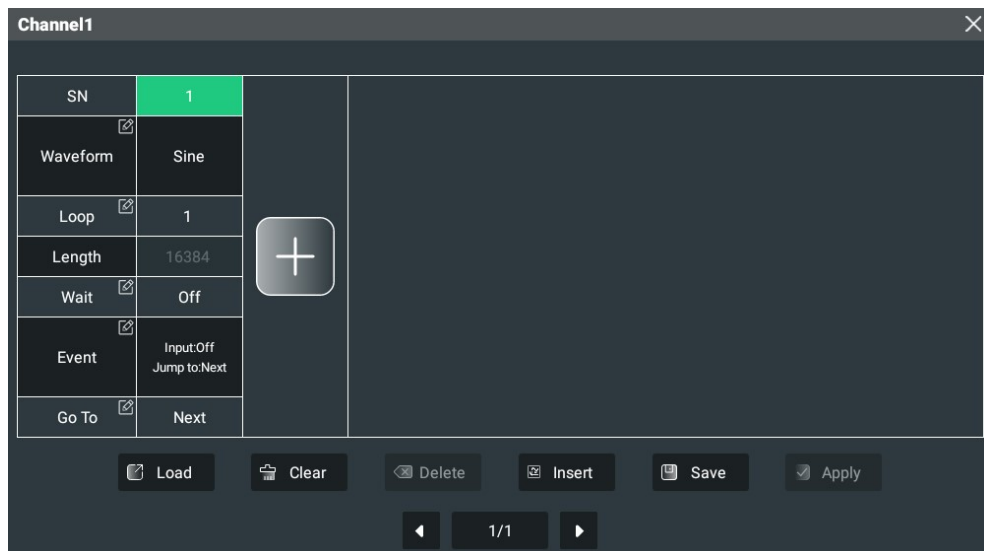





Figure 9.4 Sequence Editing Table

After the sequence editing table is enabled, it contains a step of sine wave with the loop of 1 by default. You can use the procedure below to add new steps and edit step properties for the sequence.

1. Click or tap  to add a new step at the end of the sequence. You can also select the SN of any step from the **SN** row and then click or tap **Insert** to add a step before the selected step. A sequence supports a maximum of 512 steps.

TIP

If there are too many steps for the screen to display, you can slide the table left and right or use the /  at the bottom to view other steps.

2. Click or tap the cell in the **WaveForm** row to select the waveform type for the specified step in the pop-up menu. Built-in waveforms and stored waveforms (*.arb/*.csv/*.txt) are supported.

TIP

For descriptions of the three Arb file formats, refer to *To Output Arbitrary Waveforms*.

3. Click or tap the cell in the **Loop** row to set the number of cycles with the pop-up numeric keypad for the specified step. The maximum value is 256.
4. Refer to *Output Rules* to set the **Wait**, **Event**, and **Go To** for the step.
5. After the editing, click or tap **Apply** to confirm the modification and load the sequence waveform to the current channel.

If you want to clear all the step configurations, click or tap **Clear** and the table will be restored to its default state. If you want to delete the specified step, click or tap its SN and then click or tap **Delete** to delete the selected step.

TIP

- When the wave type of the step is set to a built-in waveform, the wave length is fixed to 16384 and cannot be modified. When the wave type of the step is set to user-defined Arb, in single-ended output type, the data length range should meet the following requirements: $32 \text{ pts} \leq \text{Arb Data Length} \leq 128 \text{ Mpts}$ (256 Mpts optional), and the step total points of the current sequence cannot exceed 128 Mpts (256 Mpts optional); in differential output type, the data length range should meet the following requirements: $32 \text{ pts} \leq \text{Arb Data Length} \leq 256 \text{ Mpts}$ (512 Mpts optional), and the step total points of the current sequence cannot exceed 256 Mpts (512 Mpts optional).
- When using the sequence function, if the sample rate of the sequence exceeds 800 MSa/s, it is recommended that the waveform length of each step be no less than 200 pts; if it is necessary to perform non-sequential jumps among multiple steps (that is, the steps are executed non-sequentially through "Go to" and "Jump to"), it is recommended that the waveform length of each step be no less than 4000 pts. Insufficient step length may cause waveform disorder or unexpected clutter.

9.2.2 Output Rules

The sequence editing table displays the output rules of each step in the current sequence, as shown in the figure below. By default, the waveform starts to play sequentially by the SN without a trigger signal.

DG6000 allows you to define the output rules of any step in a sequence as required. You can define the conditions (Wait, Event, and Go To) to play the specified step in the sequence using the sequence editing table as shown in the figure below.

SN	1	2	3	4	5	6
Waveform 	Sine	Sine	Sine	Sine	Sine	Sine
Loop 	1	1	1	1	1	1
Length	16384	16384	16384	16384	16384	16384
Wait 	Off	Off	Off	Off	Off	Off
Event 	Input:Off Jump to:Next	Input:Off Jump to:Next	Input:Off Jump to:Next	Input:Off Jump to:Next	Input:Off Jump to:Next	Input:Off Jump to:Next
Go To 	Next	Next	Next	Next	Next	Next

Wait

"Wait" is used to set the conditions required for the step to start playing each cycle, including whether to wait for a trigger signal and the type of the trigger signal. In the sequence editing table, click or tap the cell in the **Wait** row of the specified step and select the wait event from the drop-down menu.

- Off: no waiting. The step plays immediately without waiting for trigger. The default setting is Off.
- Ext: waiting for trigger. The step does not start playing the waveform until an external trigger signal with a specified edge is received. You can click or tap the **Trigger** drop-down button to select the edge type of the external trigger signal in the Sequence Setting Interface (see [To Set Sequence Parameters](#)).
- Manual: waiting for trigger. The step does not start playing the waveform until a manual trigger signal is received.
- Timer: waiting for trigger. The step does not start playing the waveform until a trigger signal generated by the instrument's internal clock is received. You can click or tap the **Timer** input field to set the interval of the internally triggered signals in the Sequence Setting Interface (see [To Set Sequence Parameters](#)).

NOTE

One cycle of the step is output each time a valid trigger signal is received.



Event

You can set the event input and event jump to for each step. In the sequence editing table, click or tap the cell in the **Event** row of the step and the "Event" menu as shown in the figure below will be displayed.

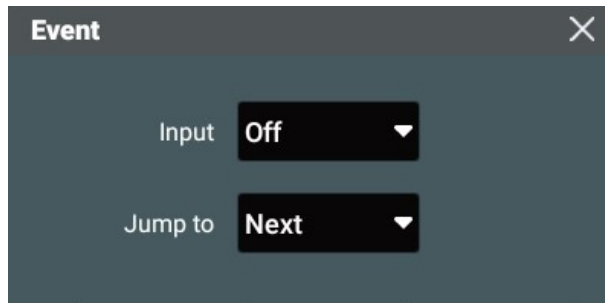

Event "Input" defines whether an event jump will occur and the type of trigger signal that will cause a jump to occur. Click or tap the **Input** drop-down button to set the event jump.

- Off: An event jump is not active for the step. The sequence uses the Go To definition after finishing this step. The default setting is "Off".
- Ext: An event jump occurs when an external trigger signal with the specified edge is received during the playout of the current step. You can click or tap the **Trigger** drop-down button to select the edge type of the external trigger signal in the Sequence Setting Interface (see [To Set Sequence Parameters](#)).
- Manual: An event jump occurs when a manual trigger signal is received during the playout of the current step.
- Timer: An event jump occurs when a trigger signal generated by the instrument's internal clock is received during the playout of the current step. You can click or tap the **Timer** input field to set the interval of the internally triggered signals in the Sequence Setting Interface (see [To Set Sequence Parameters](#)).

If the event input is not set to "Off", when the specified trigger signal is received, the sequence first completes playing the current waveform cycle and then jump to the specified destination immediately, regardless of whether the current step executes the total number of cycles. Click or tap the **Jump to** drop-down button to select the "Next", "First", or "Last" step to jump to. You can also select "Specify SN" and input the step SN with the numeric keypad.

Go To

Go To jump is used to set the target step in the sequence to jump to and play after the current step executes the total number of complete waveform cycles. In the sequence editing table, click or tap the cell in the **Go To** row of the step to set the step to go to.

- Next: The sequence goes to the next step after the current step has finished playing its waveform. It is the default setting. If "Next" is chosen for the last step

in the sequence, the sequence goes to the first step and play after the last step finishes its playout.

- **First:** The sequence goes to the first step after the current step has finished playing its waveform.
- **Last:** The sequence goes to the last step after the current step has finished playing its waveform.
- **End:** The sequence ends when finished with the current step.
- **Specify SN:** You can also specify the SN of the target step with the numeric keypad. The sequence goes to the specified step after the current step has finished playing its waveform.

9.2.3 To Save/Load Sequence

Save Sequence

After editing a sequence, you can save the sequence to the internal memory or external storage device.

1. In the interface as shown in *Figure 9.4*, click or tap **Save** and the "Store" menu is displayed.
2. Enter the target path in the internal/external memory. Click or tap **Save** and the virtual keypad is displayed.
3. Set the sequence name with the pop-up virtual keypad and then click or tap **Enter** to save the sequence. Then you can see the sequence that you saved under the target path.

Load Sequence

You can load the sequence files stored in the internal memory or external storage device.

1. In the interface as shown in *Figure 9.4*, click or tap **Load** and the "Store" menu is displayed.
2. Enter the target path in the internal/external memory and tick the sequence file (*.seq) that you want to load.
3. Click or tap **Load** and the instrument will open the file in the sequence editing table and apply to the current channel.



TIP

For general operations of the "Store" menu, please refer to *Storage Management*.

9.2.4 To Set Sequence Parameters

In the interface as shown in *Figure 9.3*, you can also set the following parameters.

Set the Sample Rate

Click or tap the **Sample Rate** input field to set the sample rate for the sequence. The sample rate ranges from 1 μ Sa/s to 1.25 GSa/s, and the default is 1 MSa/s.

Set the Amplitude Range (Differential)

Please refer to *To Output Sine Wave* to set the amplitude range.

Set the Amplitude Range/High Level (Single-ended)

Refer to *To Output Sine Wave* to set the amplitude range/high level. Note that V_{rms} and dBm are not available for the unit of the sequence amplitude range.

Set the Offset (Differential)

Please refer to *To Output Sine Wave* to set the offset.

Set the Offset/Low Level (Single-ended)

Refer to *To Output Sine Wave* to set the offset/low level.

Set the Filter Mode

Click or tap the **Filter** drop-down button to select the filter mode.

- **Normal:** It has wide and flat frequency response as well as short edge time, but the step response produces a large overshoot.
- **Step:** It has more ideal step response, narrow bandwidth, longer rise/fall time, and longer edge time.
- **Edge:** It allows you to define the edge time to create bursts with arbitrary edge time. When "Edge" is selected, you can click or tap the **Filter** input field to set the edge time. When the sample rate is less than 400 MSa/s, the range is from 2 ns to $0.8 \cdot (1/\text{Sample Rate})$ and cannot exceed 1 μ s. When the sample rate is greater than or equal to 400 MSa/s, it is fixed to $0.8 \cdot (1/\text{Sample Rate})$. The resolution of the edge time is 100 ps.
- **Interpolation:** It guarantees the output of signals with no distortion at all.

Set the External Trigger Mode

Click or tap the **Trigger** drop-down button to select "Leading" or "Trailing".

TIP

When the "Wait" or the Event "Input" of the specified step is set to "Ext", to make sure that each input event is responded, the arrival interval of these events should meet the following:



Event Input Cycle > Step Output Time. If the event input cycle is less than the threshold, excess events will be ignored.

Set the Timer

Click or tap the **Timer** input field to set the interval to generate internally triggered signals. The available range is from 4 μ s to 8000 s.



TIP

When the "Wait" or the Event "Input" of the specified step is set to Timer, to make sure that each timer signal is responded, the timer should be greater than the step output time. If the timer is less than the threshold, excess signals will be ignored.

9.3 PRBS

Pseudo Random Binary Sequence (PRBS) can be generated using a Linear Feedback Shift Register (LFSR), as shown in the figure below.

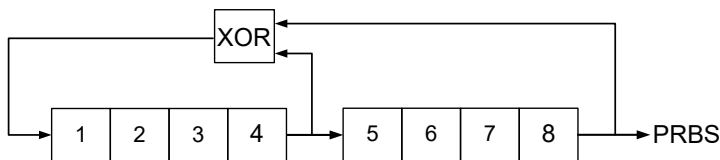

An LFSR is determined by the number of stages (L) it contains and which of those stages ("taps") feed the exclusive-or (XOR) gates in its feedback network. The PRBS output is taken from the last stage. With properly selected taps, an L-stage LFSR generates a repetitive PRBS with the length of 2^L-1 . The clock frequency of the LFSR determines the "bit rate" of the PRBS.

PRBS supports PRBS3 to PRBS32. The initial value of PRBS is 0x1, and the corresponding PRBS polynomials are as shown in the table below.

Table 9.1 PRBS Polynomial Expression

PRBS Type	Polynomial Expression	PRBS Type	Polynomial Expression
PRBS3	x^3+x+1	PRBS18	$x^{18}+x^5+x^2+x+1$
PRBS4	x^4+x+1	PRBS19	$x^{19}+x^5+x^2+x+1$
PRBS5	x^5+x^2+1	PRBS20	$x^{20}+x^3+1$
PRBS6	x^6+x+1	PRBS21	$x^{21}+x^2+1$
PRBS7	x^7+x^3+1	PRBS22	$x^{22}+x+1$
PRBS8	$x^8+x^4+x^3+x^2+1$	PRBS23	$x^{23}+x^5+1$

PRBS Type	Polynomial Expression	PRBS Type	Polynomial Expression
PRBS9	x^9+x^4+1	PRBS24	$x^{24}+x^4+x^3+x+1$
PRBS10	$x^{10}+x^3+1$	PRBS25	$x^{25}+x^3+1$
PRBS11	$x^{11}+x^2+1$	PRBS26	$x^{26}+x^6+x^2+x+1$
PRBS12	$x^{12}+x^6+x^4+x+1$	PRBS27	$x^{27}+x^5+x^2+x+1$
PRBS13	$x^{13}+x^4+x^3+x+1$	PRBS28	$x^{28}+x^3+1$
PRBS14	$x^{14}+x^5+x^3+x+1$	PRBS29	$x^{29}+x^2+1$
PRBS15	$x^{15}+x+1$	PRBS30	$x^{30}+x^6+x^4+x+1$
PRBS16	$x^{16}+x^{12}+x^3+x+1$	PRBS31	$x^{31}+x^{28}+1$
PRBS17	$x^{17}+x^3+1$	PRBS32	$x^{32}+x^7+x^6+x^2+1$

In the Advanced Waveform Setting Interface, click or tap the "Sub Mode" drop-down button to select "PRBS" to enter the PRBS Setting Interface, as shown in the figure below.

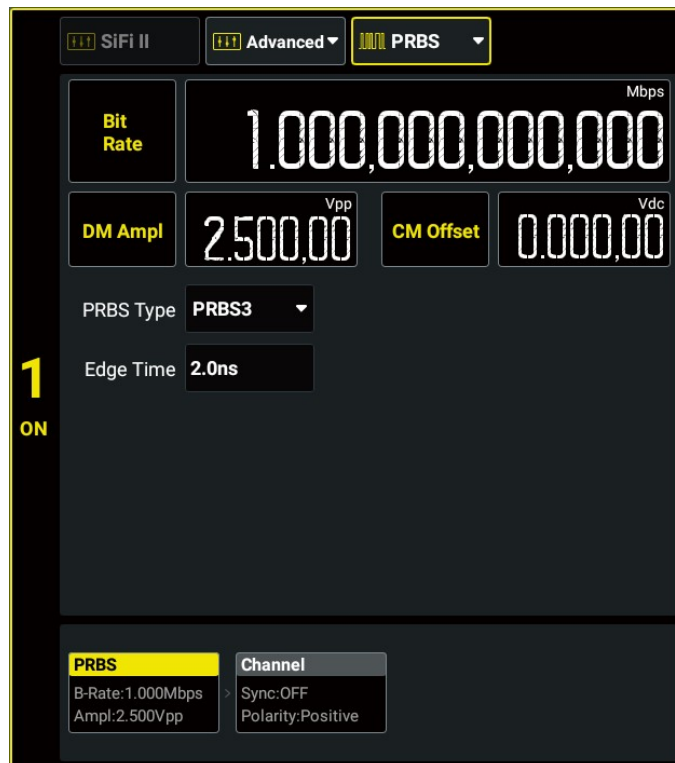

Figure 9.6 PRBS Setting Interface

After entering the PRBS Setting Interface, you can set the following parameters.

Set the Bit Rate

Click or tap the **Bit Rate** input field to set the bit rate for PRBS. The available range is from 1 μ bps to 300 Mbps, and the default is 1 Mbps.

Set the Amplitude Range (Differential)

Click or tap the **DM Ampl** input field to set the amplitude range for PRBS.

Set the Amplitude Range/High Level (Single-ended)

Click or tap the **Ampl/HighL** input field to set the amplitude range/high level for PRBS. Note that Vrms and dBm are not available for the unit of the PRBS.

Set the Offset (Differential)

Click or tap the **CM Offset** input field to set the offset for PRBS.

Set the Offset/Low Level (Single-ended)

Click or tap the **Offset/LowL** input field to set the offset/low level for PRBS.

Set the PRBS Type

Click or tap the **PRBS Type** drop-down button to select the data type for PRBS. The available range is from PRBS3 to PRBS32. The length of PRBSn is $2^n - 1$.

Set the Edge Time

Click or tap the **Edge Time** input field to set the duration time of the pulse edge (10% to 90%). The available range is from 2 ns to 1 μ s. The actual maximum edge time is limited by the current bit rate.

9.4 Multi-pulse

The Multi-pulse signal is a signal sequence composed of multiple pulses. You can set the number of pulses as well as the width of each pulse for the Multi-pulse waveforms to meet specific test requirements.

In the Advanced Waveform Setting Interface, click or tap the "Sub Mode" drop-down button to select "M-Pulse" to enter the Multi-pulse Setting Interface, as shown in the figure below.

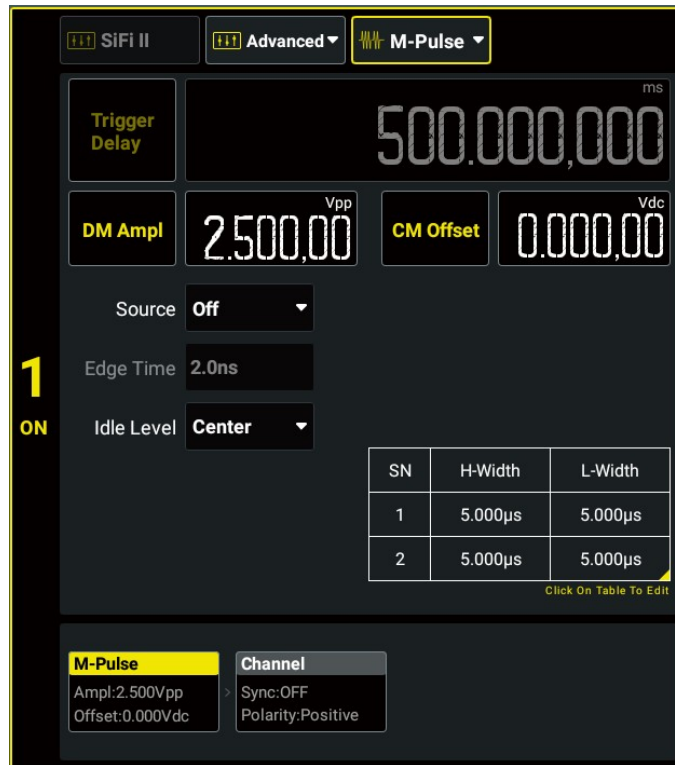

Figure 9.7 Multi-pulse Setting Interface

In the Multi-pulse Setting Interface, click or tap the "Waveform Preview/Editing" area to enter the Multi-pulse Setting Menu, as shown in the figure below. In this menu, you can set the pulse count, edge time, and high/low pulse width for the multi-pulse waveforms. You can click or tap **Apply** to confirm and apply the modifications.

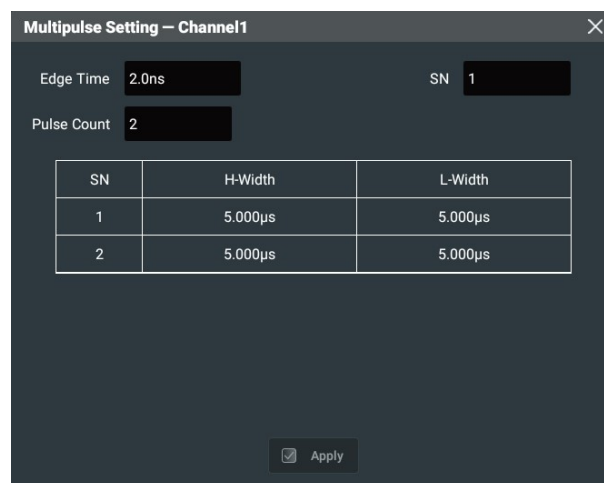

Figure 9.8 Multi-pulse Setting Menu

Set the Pulse Count

In the Multi-pulse Setting Menu (*Figure 9.8*), click or tap the **Pulse Count** input field to set the number of pulses with the pop-up numeric keypad. The available range is from 2 to 30.

Set the Pulse High/Low Level Width

In the editing table of the Multi-pulse Setting Menu (*Figure 9.8*), click or tap the cell in the **H-Width/L-Width** column to set the high/low level width for the specified pulse with the pop-up numeric keypad. The available range is from 20 ns to 150 μ s.

TIP

When there are a large number of pulses, you can click or tap the **SN** input field to set the SN of the pulse to locate the specified pulse quickly.

Set the Edge Time

In the Multi-pulse Setting Menu (*Figure 9.8*), click or tap the **Edge Time** input field to set the edge time for the Multi-pulse waveform. The available range is from 2 ns to 1 μ s. The actual range is limited by the minimum high/low level width.

Set the Trigger Source

In the Multi-pulse Setting Interface (*Figure 9.8*), click or tap the **Source** drop-down button to set the trigger source to "Off", "Ext", "Manual", or "Timer".

- Off: The trigger function is disabled. When the channel output is turned on, the multi-pulse waveform can be output without waiting for the trigger signal.
- Ext: The multi-pulse waveform is output when the trigger signal with the specified edge is received via the rear-panel **[AUX IN]** connector. When "Ext" is selected, you can click or tap the **Ext** drop-down button to select "Leading" or "Trailing".
- Manual: The multi-pulse waveform is output when a manual trigger signal is received.
- Timer: The multi-pulse waveform is output when the trigger signal generated by the instrument's internal clock is received. After "Timer" is selected, you can click or tap the input field of **Timer** to set the interval for generating the internally triggered signals. The available range is from 5 μ s to 8 ks. The actual minimum value is limited by the trigger delay time and the high and low pulse width sum:

$$\text{Timer} \geq \text{Trigger Delay} + \text{High Pulse Width Sum} + \text{Low Pulse Width Sum}.$$

NOTE

When the trigger source is set to "Ext", to make sure that each input event is responded, the arrival interval of these events should meet the following: $\text{Event Input Cycle} \geq \text{Trigger Delay} + \text{High Pulse Width Sum} + \text{Low Pulse Width Sum}$. If the event input cycle is less than the threshold, excess events will be ignored.

Set the Idle Level

In Multi-pulse mode, the output will not be turned off when there is no pulse output but will remain at a specified voltage level, which is called the idle level. In the Multi-

pulse Setting Interface (*Figure 9.8*), click or tap the **Idle Level** drop-down button to select the idle level.

- 1st Pt: sets the level at the first point of the Multi-pulse waveform as the idle level.
- Top: sets the level at the top point of the Multi-pulse waveform as the idle level.
- Center: sets the level at the center point of the Multi-pulse waveform as the idle level.
- Bottom: sets the level at the bottom point of the Multi-pulse waveform as the idle level.

Set the Trigger Delay

Trigger delay is the duration from the time when the instrument receives the trigger signal to the time when it starts to output the multi-pulse signal. When **Source** is set to "Off", this item is not available. In the Multi-pulse Setting Interface (*Figure 9.8*), click or tap the **Trigger Delay** input field to set the trigger delay with the pop-up numeric keypad. The available range is from 5 μ s to 1 s.

Set the Amplitude Range (Differential)

In the Multi-pulse Setting Interface (*Figure 9.8*), click or tap the **DM Ampl** input field to set the amplitude range for the multi-pulse waveform.

Set the Amplitude Range/High Level (Single-ended)

In the Multi-pulse Setting Interface (*Figure 9.8*), click or tap the **Ampl/HighL** input field to set the amplitude range/high level for the multi-pulse waveform. Note that Vrms and dBm are not available for the amplitude range unit of the Multi-pulse.

Set the Offset (Differential)

In the Multi-pulse Setting Interface (*Figure 9.8*), click or tap the **CM Offset** input field to set the offset for the multi-pulse waveform.

Set the Offset/Low Level (Single-ended)

In the Multi-pulse Setting Interface (*Figure 9.8*), click or tap the **Offset/LowL** input field to set the offset/low level for the multi-pulse waveform.

9.5 Multi-tone

A multi-tone waveform is the superposition of multiple tones (sine) with different frequencies. The on/off, amplitude range, and phase of each tone can be set separately. In the frequency domain, the multi-tone signal is represented as multiple discrete frequency components, providing a wealth of spectral information. The multi-tone signals are widely used for test and measurement in audio, communications, and power electronics.

In the Advanced Waveform Setting Interface, click or tap the "Sub Mode" drop-down button to select "M-Tone" to enter the Multi-tone Setting Interface, as shown in the figure below.



Figure 9.9 Multi-tone Setting Interface

After entering the Multi-tone Setting Interface, you can set the following parameters.

Set the Tone Parameters

In the Multi-tone Setting Interface as shown in *Figure 9.9*, click or tap the "Waveform Preview/Editing" area to open the "Multitone Setting" menu, as shown in the figure below.

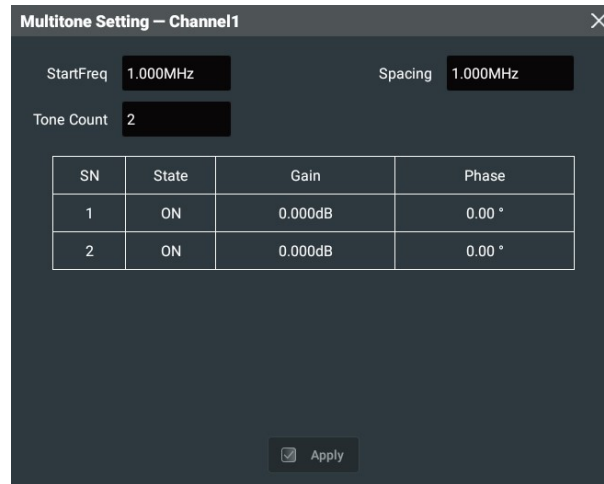

Figure 9.10 Multi-tone Setting Menu

1. Click or tap the **StartFreq** input field to set the start frequency with the pop-up numeric keypad. The available range is from 1 kHz to 499.999 MHz.



NOTE

In actual use, the Start Frequency, Spacing, and Tone Count are constrained. Start Frequency + Spacing*(Tone Count - 1) ≤ 500 MHz. Their values cannot exceed the range.

2. Click or tap the **Spacing** input field to set the frequency spacing between tones with the pop-up numeric keypad. The available range is from 1 kHz to 499.999 MHz.
3. Click or tap the **Tone Count** input field to set the number of tones with the pop-up numeric keypad. The available range is from 2 to 16.
4. Click or tap the cell in the **State** column to turn on or off the specified tone.
5. Click or tap the cell in the **Gain** column to set the gain of the specified tone with the pop-up numeric keypad. The available range is from -20 dB to 0 dB.
6. Click or tap the cell in the **Phase** column to set the phase of the specified tone with the pop-up numeric keypad. The available range is from 0° to 360°.
7. After editing, click or tap **Apply** to confirm the modifications and set the multi-tone waveforms as the waveform of the current channel.

Set the Amplitude Range (Differential)

In the Multi-tone Setting Interface (*Figure 9.9*), click or tap the **DM Ampl** input field to set the amplitude range for the multi-tone waveform.

Set the Amplitude Range/High Level (Single-ended)

In the Multi-tone Setting Interface (*Figure 9.9*), click or tap the **Ampl/HighL** input field to set the amplitude range/high level for the multi-tone waveform. Note that

Vrms and dBm are not available for the amplitude range unit of the multi-tone waveforms.

Set the Offset (Differential)

In the Multi-tone Setting Interface (*Figure 9.9*), click or tap the **CM Offset** input field to set the offset for the multi-tone waveform.

Set the Offset/Low Level (Single-ended)

In the Multi-tone Setting Interface (*Figure 9.9*), click or tap the **Offset/LowL** input field to set the offset/low level for the multi-tone waveform.

9.6 Pattern

The pattern generator can generate user-defined digital signal sequences used for the debugging and verification of digital circuits and systems.

In the Advanced Waveform Setting Interface, click or tap the "Sub Mode" drop-down button to select "Pattern" to enter the Pattern Setting Interface, as shown in the figure below.

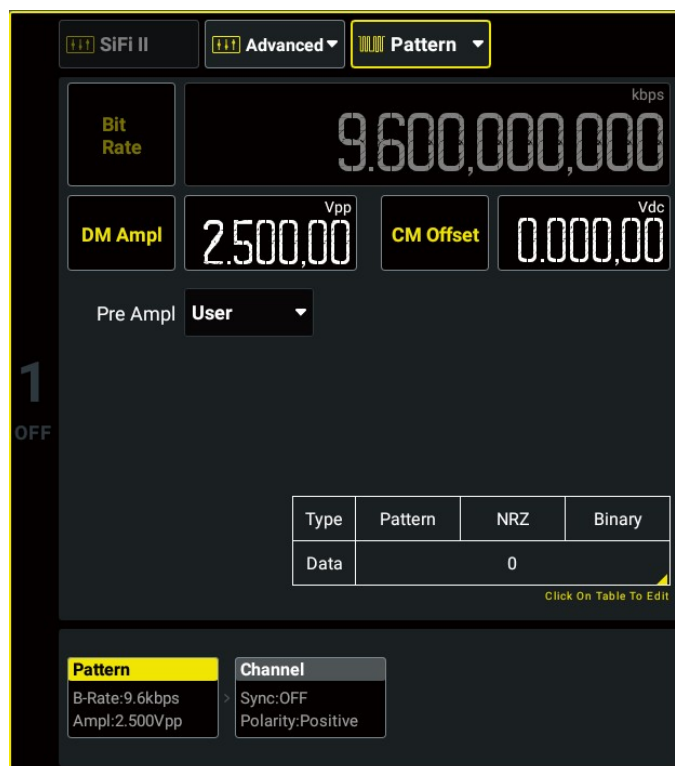

Figure 9.11 Pattern Setting Interface

In the Pattern Setting Interface, click or tap the "Waveform Preview/Editing" area to open the Pattern Setting Menu, as shown in the figure below. In this menu, you can set the bit rate, data type, encoding type, data format, and other parameters for the pattern. You can click or tap **Apply** to confirm and apply the modifications.

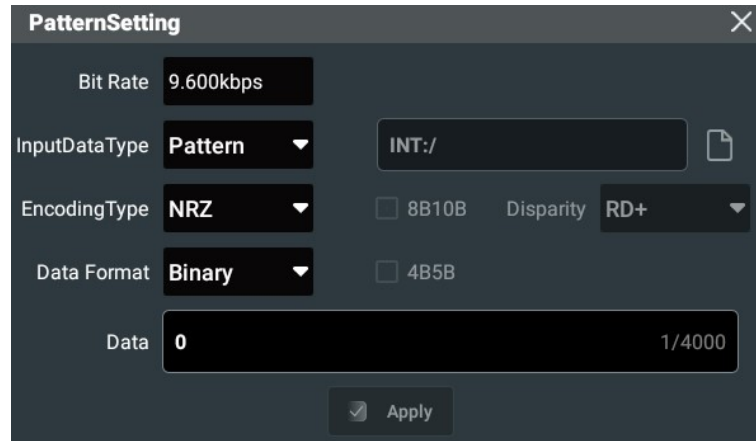

Figure 9.12 Pattern Setting Menu

Set the Output Amplitude Range

In the Pattern Setting Interface (*Figure 9.11*), click or tap the **DM Ampl** or **CM Offset** input field to self-define the output amplitude range. When the output type is set to single-ended, you can click or tap the **Ampl/HighL** or **Offset/LowL** input field to self-define the output amplitude range.

TIP

In HBW differential output, **Pre Ampl** is fixed to "User" and cannot be modified.

Click or tap the **Pre Ampl** drop-down button to select the preset amplitude format for pattern output. After the specified amplitude format is selected, the amplitude range-offset (high level-low level) will be automatically modified to the value corresponding to the amplitude format, as shown in the table below. Please note that in AMP differential output, due to the 50 Ω impedance, after selecting the corresponding preset amplitude, the amplitude range and offset displayed by the instrument are half of the values in the following table.

Table 9.2 Pattern Preset Amplitude (SND, HighZ)

Amplitude Type	Amplitude Range	Offset
TTL	5.0 Vpp	2.5 Vdc
CMOS5.0	5.0 Vpp	2.5 Vdc
CMOS3.3	3.3 Vpp	1.65 Vdc
CMOS2.5	2.5 Vpp	1.25 Vdc
CMOS1.8	1.8 Vpp	900 mVdc

Amplitude Type	Amplitude Range	Offset
ECL	5.2 Vpp	-2.6 Vdc
PECL	800 mVpp	2.0 Vdc

Set the Bit Rate

In the Pattern Setting Menu (*Figure 9.12*), click or tap the **Bit Rate** input field to set the bit rate with the pop-up numeric keypad. The available range is from 1 μ bps to 300 Mbps, and the default value is 9.6 kbps. The bit rate will be displayed in the **Bit Rate** item in the *Figure 9.11* interface.

Set the Input Data Type

In the Pattern Setting Menu (*Figure 9.12*), click or tap the **InputDataType** drop-down button to set the data type to "Pattern" or "File".

- Pattern: set the input data type to self-defined symbol for the pattern generator. When "Pattern" is selected, you can click or tap the Data input field to define the data with the pop-up numeric keypad. The maximum length is 4000 characters for binary and 1000 characters for hexadecimal and KD symbol.
- File: import user-defined symbol via the internal memory/external USB storage device. When "File" is selected, you can click or tap the file path input field or  to select the target file in the displayed storage menu and then click or tap **Load**. After the file is successfully loaded, the data type of the imported file is displayed in the import icon: B (binary), H (hexadecimal), S (KD symbol).

The maximum data length of the imported file is related to the data format of the file. The data length is limited to 64M characters for binary and 12M characters for hexadecimal and KD symbol.

NOTE

DG6000 only supports files of *.txt format. The data in the binary file should start with b, for example, b1100101010. The data in the hexadecimal file should start with h, for example, h123ABE5. The data in the KD symbol file should start with s and be separated by comma, for example, sD1.3,D2.3.

Set the Encoding Type

In the Pattern Setting Menu (*Figure 9.12*), click or tap the **EncodingType** drop-down button to select "NRZ", "RZ", or "Manchester".

- NRZ: Non-Return-to-Zero
- RZ: Unipolar Return-to-Zero



- Manchester: Manchester encoding. Transition from low to high in the middle of bit period represents "0"; transition from high to low in the middle of bit period represents "1".

Set the Data Format

When the input data type is set to "Pattern", you can click or tap the **Data Format** drop-down button to set the pattern type to "Binary", "Hex", or "Symbol".

Input the Data

When the input data type is set to "Pattern", you can click or tap the "Data" input field to set the data with the pop-up numeric keypad.

When the data format is set to "Binary", you can only use "0", "1", "CE", "Back", and "Enter" keys while other keys are disabled. When the data format is set to "Hex", you can use "0-9", "A-F", "CE", "Back", and "Enter" keys while other keys are disabled. When the data format is set to "Symbol", you can use "0-9", "K", "D", ".", ",", "CE", "Back", and "Enter" keys while other keys are disabled.

8B10B Encoding

8B10B encoding is used to encode a byte (8-bit data) to 10-bit data. It is available only when the data format of the input pattern or the imported file is set to "Symbol". Otherwise, it is grayed out. After the 8B10B encoding function is enabled, you can set the polarity of the 8B10B encoding. Disparity is the difference between the number of 1 bits and 0 bits of the first code value after encoding. Available options include RD+ (more 0 bits than 1 bits or equal number of 1 bits and 0 bits) and RD- (more 1 bits than 0 bits or equal number of 1 bits and 0 bits).

4B5B Encoding

4B5B encoding is used to encode 4 bits of data to a 5-bit code. It is available only when the data format of the input pattern or the imported file is set to "Hex". Otherwise, it is grayed out.

9.7 IQ Waveform

In IQ Modulation, the input data is mapped to the corresponding in-phase (I) and quadrature (Q) components through the specified mapping rule (modulation). The two components are then modulated by the carrier to obtain $s(t)$ signal. The block diagram of IQ modulation is as shown in the figure below.

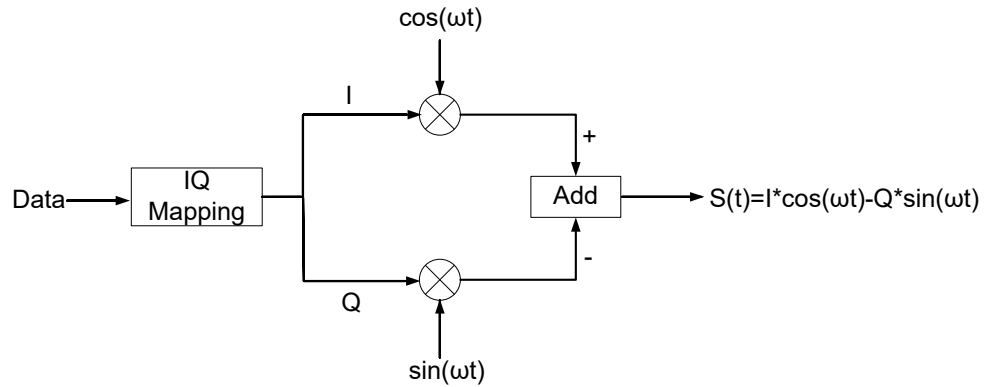

Figure 9.13 Block Diagram of IQ Modulation

When the output type is set to single-ended or HBW differential, you can set the IQ modulation. In the Advanced Waveform Setting Interface, click or tap the "Sub Mode" drop-down button to select "IQ" to enter the IQ Setting Interface, as shown in the figure below.

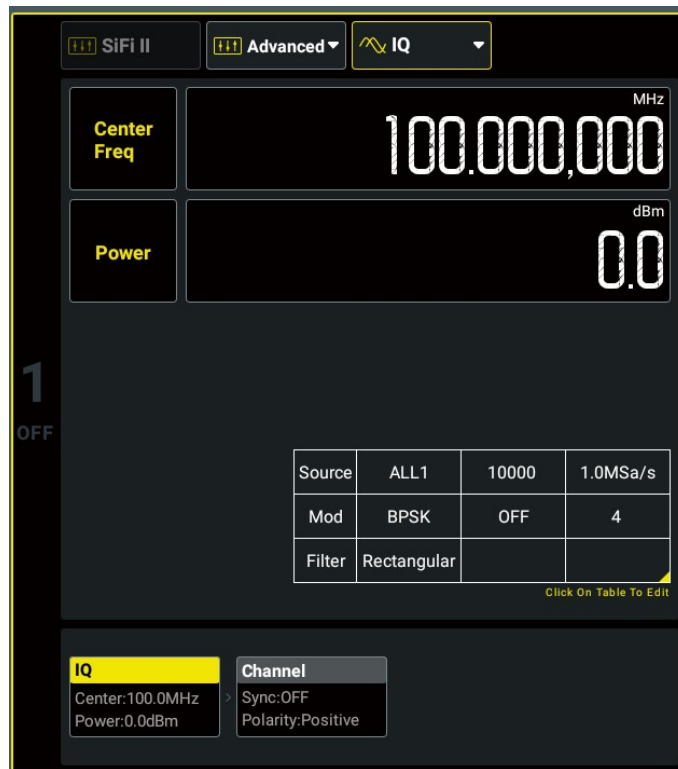

Figure 9.14 IQ Setting Interface



TIP

When the output type is single-ended, IQ modulation requires the resources of two channels. Therefore, for 4-channel models, only CH1/CH2/CH3/CH4 is allowed to enable IQ modulation, and when CH1/CH2/CH3/CH4 enables IQ modulation, its corresponding CH5/CH6/CH7/CH8 is disabled; for 2-channel models, only CH1/CH2 is allowed to enable IQ modulation, and when CH1/CH2 enables IQ modulation, its corresponding CH3/CH4 is disabled.

In the IQ Setting Interface, click or tap the "Waveform Preview/Configuration" area to open the IQ Setting Menu, as shown in the figure below. In this menu, you can set the data source, modulation parameters, and the filter type for the IQ waveform. Click or tap **Apply** to confirm and apply the modifications.

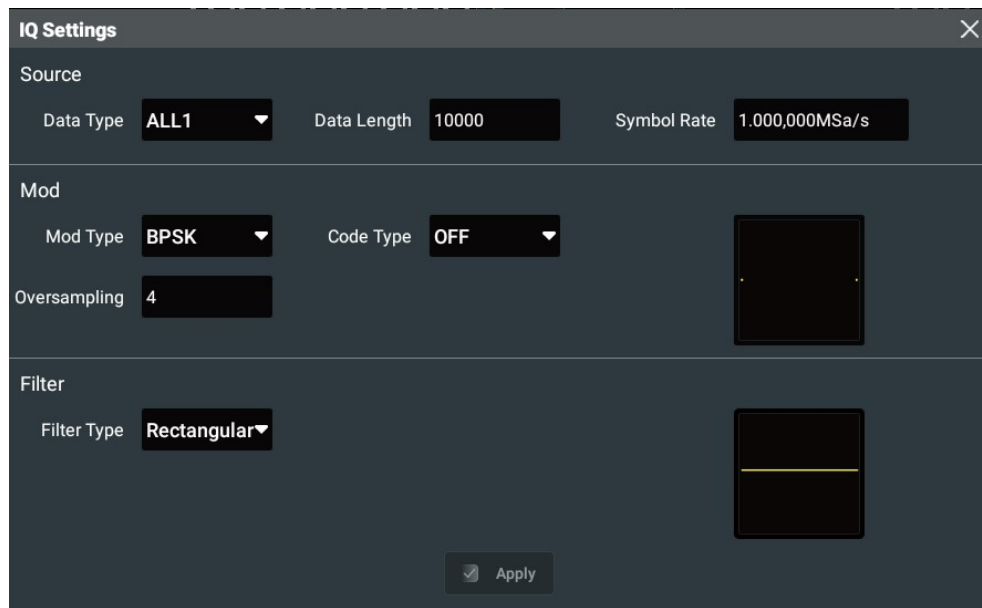

Figure 9.15 IQ Setting Menu

Set the Data Type

In the IQ Setting Menu (*Figure 9.15*), click or tap the **Data Type** drop-down button to select the data type for the IQ waveform.

- ALL1: set the data type to a sequence in which all bits are 1.
- ALL0: set the data type to a sequence in which all bits are 0.
- PRBSn: set the data type to PRBS9, PRBS11, PRBS15, PRBS16, PRBS20, PRBS21, or PRBS23.

Set the Data Length

In the IQ Setting Menu (*Figure 9.15*), click or tap the **Data Length** input field to set the data length with the pop-up numeric keypad. The available range is from 10 to 20M, and the default is 10k. When the data length does not match the modulation scheme, the system automatically adjusts the data length. To ensure the integrity of the input data, it is recommended to match the input data length with the selected modulation scheme. For example, it is recommended to set the data length of 8PSK (symbol length= $\log_2 8=3$) to an integer multiple of 3 and the length of 256QAM (symbol length= $\log_2 256=8$) to an integer multiple of 8.

Set the Symbol Rate

Symbol rate refers to the number of symbols transmitted per second. In the IQ Setting Menu (*Figure 9.15*), click or tap the **SymbolRate** input field to set the symbol rate with the pop-up numeric keypad. The available range is from 100 Sa/s to 100 MSa/s, and the default is 1 MSa/s.

Set the Modulation Type

In the IQ Setting Menu (*Figure 9.15*), click or tap the **Mod Type** drop-down menu to select the IQ scheme. DG6000 supports 8 modulation schemes: BPSK, QPSK, 8PSK, 16QAM, 32QAM, 64QAM, 128QAM, and 256QAM. Based on your selection, the constellation diagram of the corresponding modulation scheme is displayed in the **Mod** area. For example, the constellation diagram of 8PSK is shown in the figure below.



Set the Code

In the IQ Setting Menu (*Figure 9.15*), click or tap the **CodeType** drop-down button to select OFF, Differential (Diff), Differential+Gray (Dgray), or Gray.

Set the Oversampling

Oversampling refers to the interpolation and filtering of the IQ baseband signal to output the signal at a higher sampling rate. If the original IQ baseband signal symbol rate R_s is raised to a signal with a sample rate of $f_s = R \times R_s$ after oversampling, R is the factor by which the signal is oversampled. In the IQ Setting Menu (*Figure 9.15*), click or tap the **Oversampling** input field to set the oversampling. The available range is from 1 to 16, and the default is 4.

TIP

The sampling rate is automatically calculated based on the oversampling and symbol rate. The oversampling x symbol rate must be smaller than or equal to the maximum sampling rate (1.25 GSa/s). Otherwise, the system automatically changes the oversampling to meet the requirements.



Set the Filter

In the IQ Setting Menu (*Figure 9.15*), click or tap the **FilterType** drop-down button to select the filter type.

- **Rectangular:** Window filter. It passes all signals with frequency lower than a given cutoff frequency, and removes all frequency components above the cutoff frequency. Its frequency response is a rectangular function.
- **Cosine:** Cosine filter. When selecting the cosine filter, you need to set the roll-off factor. The available range is from 0.05 to 1, and the default is 0.25.
- **Root:** Root cosine filter. When selecting the root cosine filter, you need to set the roll-off factor. The available range is from 0.05 to 1, and the default is 0.25.

Set the Center Frequency

In the IQ Setting Interface (*Figure 9.14*), click or tap the **CenterFreq** input field to set the center frequency with the pop-up numeric keypad. The available range is from 0 Hz to 500 MHz.

Set the Power

In the IQ Setting Interface (*Figure 9.14*), click or tap the **Power** input field to set the power with the pop-up numeric keypad. In HBW differential output type, the power ranges from -3.9 dBm to 10.0 dBm. In single-ended output type, the range is from -56 dBm to 23.9 dBm and the actual range is related to the center frequency.

10 Arb Build

This series Function/Arbitrary Waveform Generator provides the Arb editing function.

Click or tap  > **Arb Build** to enter the Arb Build Interface, as shown in the figure below.

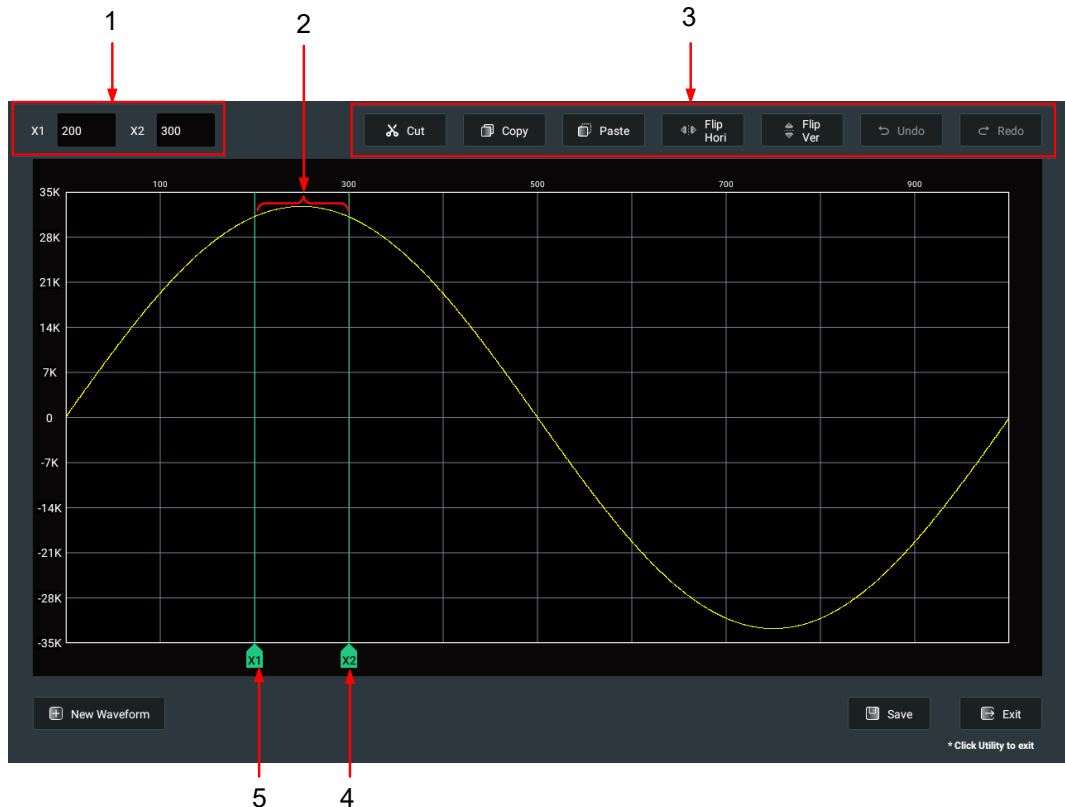

Figure 10.1 Arb Build Interface

1. Cursor horizontal value input fields. The input fields display the horizontal values of the cursor x1 and x2. You can set the two values.
2. Selected Waveform. The waveform between cursor x1 and cursor x2 is the selected waveform. You can edit the selected waveform using the function keys in the menu bar at the top of the interface.
3. Menu bar. You can use the function keys to edit the selected waveform.
4. x2 cursor.
5. x1 cursor.

Create New Arb Waveform

Click or tap **New Waveform** to open the "Waveform" menu. Click or tap the **Function** input field and select the waveform type in the displayed menu. Set the waveform

length, loop, and other parameters. Then click or tap **Apply** to create a new Arb waveform.



TIP

- When the waveform type is set to basic, the maximum of waveform length*loop is 16,384 pts; otherwise, the waveform length is fixed to 16,384 pts and the loop is fixed to 1.
- The waveform parameters that need to be set depend on the waveform type you select.

Edit the Arb Waveform

The newly created waveform will be displayed in the Arb editing area. The selected waveform is between the cursor x1 and the cursor x2, as shown in the figure above. You can select parts of the waveform by dragging the cursor or entering coordinate values in the cursor input field in the upper left corner of the interface to adjust the position of the cursor x1 and cursor x2. You can cut, copy, paste, or flip the selected waveform.

- Cut: Click or tap **Cut** in the menu bar to cut the current waveform to the data cache.
- Copy: Click or tap **Copy** in the menu bar to copy the current waveform to the data cache.
- Paste: Click or tap **Paste** in the menu bar and select the paste location in the pop-up menu. Then click or tap **Apply** to paste the copied or cut waveform to the specified location.

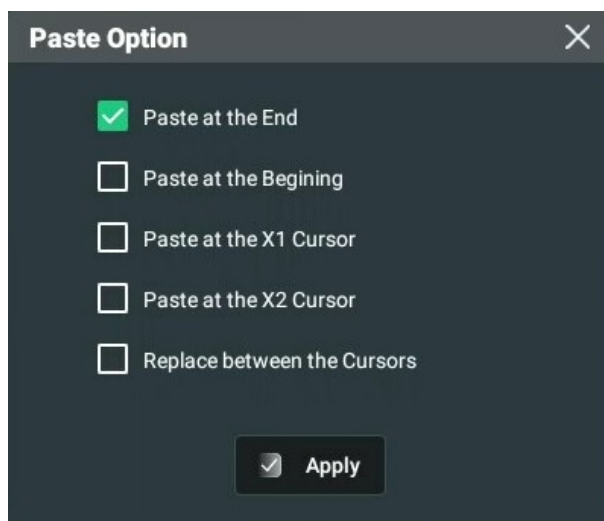

- Flip Horizontal: Click or tap **Flip Hori** in the menu bar to flip the selected waveform horizontally.
- Flip Vertical: Click or tap **Flip Ver** in the menu bar to flip the selected waveform vertically.
- Undo: Click or tap **Undo** in the menu bar to undo the last edit of the Arb waveform. Only one undo operation is allowed.

- Redo: Click or tap **Redo** in the menu bar to cancel the last undo operation. Only one redo operation is allowed.

Save the Arb Waveform

After the Arb editing, you can save the Arb waveform in the internal/external storage menu in *.arb file format.

1. In the Arb Build Interface, click or tap **Save** and the "Store" menu is displayed.
2. Enter the target path in the internal/external memory. Click or tap **Save** and the virtual keypad is displayed.
3. Set the Arb name with the pop-up virtual keypad and then click or tap **Enter** to save the self-defined Arb file. Then you can see the Arb file that you saved under the target path.



TIP

You can also use a PC software (e.g. Ultra Station) to edit the Arb waveform and then use a USB storage device or FTP to transfer the file to the instrument's local memory (C disk).

11 Output Type

This series Function/Arbitrary Waveform Generator provides three output types: SND, HBW, and AMP (default). Click or tap  > **Output Type** to open the menu, as shown in the figure below.

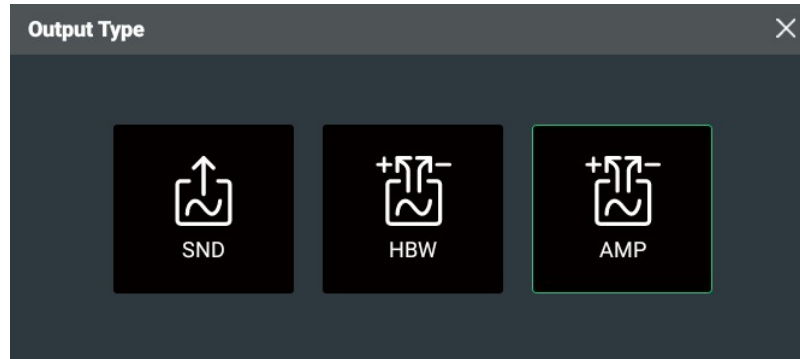

- **SND**: The instrument outputs signals through the front-panel BNC interfaces, and each channel supports two single-ended signal outputs (2-channel models: CH1, CH2, CH3, CH4; 4-channel models: CH1, CH2, CH3, CH4, CH5, CH6, CH7, CH8).
- **HBW**: The instrument outputs high-bandwidth differential signals through a pair of differential output interfaces (SMB) on the front panel.
- **AMP**: The instrument outputs amplitude-amplified differential signals through the front-panel BNC interface.

For the output characteristics of different output types, please refer to the *DG6000 Data Sheet*.



NOTE

- When only one of the pair of SMB differential output interfaces is used to output signals, the other port must be connected to the 50 Ω load.
- In differential output type, the signal amplitude range set is the peak-to-peak value ($V_{pp} = (V_+ - V_-)_{pp}$) of the differential signals. The differential amplitude range set is actually twice the peak-to-peak value of the output signal from a single port (+/-).
- Upon switching the output type, the instrument resets to default values.
- The BNC interface and the SMB interface cannot output singles simultaneously. After the HBW differential output is enabled, the BNC interface will stop outputting signals.

12 Channel Setup

In the user interface, click or tap the Channel Tab to enter the Channel Setup Interface, as shown in the interface below.

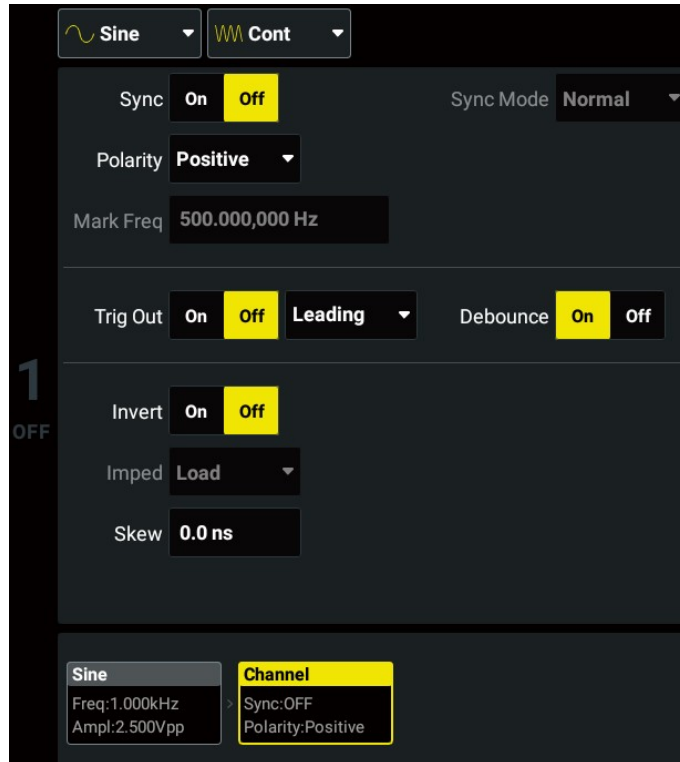

Figure 12.1 Channel Setup Interface

12.1 Sync Signal Setup

This series instrument can output the sync signals of basic waveforms (except noise, DC, and harmonic), sweep waveforms, bursts, modulated waveforms, and Advanced Arb waveforms. The instrument outputs the sync signals of each channel via the front-panel **[Sync Out]** connector. You can set the on/off and output polarity for the sync signals of each channel.

Sync On/Off

Click or tap the **Sync** on/off switch to enable or disable the output of the sync signal. If the Sync function is enabled, the sync signal is output from the front-panel **[Sync Out]** port when the channel output is enabled. For details about the sync signal, refer to [Table 12.1 Sync Signal of Different Output Modes \(Positive Polarity\)](#).

TIP

When the external trigger source or external modulation source is selected, the sync output is disabled. When the trigger output is enabled, the sync output is disabled automatically.



Sync Polarity

It sets the output polarity of the sync signal to trigger an external device that may require rising edge trigger or falling edge trigger. Click or tap the **Polarity** drop-down button to select "Positive" or "Negative".

- **Positive:** outputs normal sync signals.
- **Negative:** outputs inverted sync signals.

Mark Frequency

When the output mode is set to "Sweep", you can set the **sync mode** to "Mark". After the "Mark" function is enabled, the sync signal goes low at the specified mark frequency. For details, please refer to [Mark Frequency](#).

Table 12.1 Sync Signal of Different Output Modes (Positive Polarity)

Output Mode	Descriptions
Continuous Mode	<p>In Continuous mode (except noise, DC, and harmonic), the sync signal is a square waveform with 50% duty cycle. The frequency of the sync signal is related to the waveform output frequency.</p> <ul style="list-style-type: none"> • Output frequency ≤ 30 MHz: sync signal frequency is equal to the frequency of the output signal. • Output frequency ≤ 60 MHz: the sync signal frequency is waveform frequency/2. • Output frequency ≤ 120 MHz: the sync signal frequency is waveform frequency/4. • Output frequency ≤ 1 GHz: the sync signal frequency is waveform frequency/8. <p>Note: When square is selected for the Continuous mode and the fast transition is enabled, or when sine is selected and the output frequency is > 5 MHz, the sync signal has a fixed delay of 8 ns relative to the waveform signal.</p>
Modulation Mode	<p>In Modulation mode, the sync signal is a square waveform with 50% duty cycle. In the first half period of the waveform, the sync signal is a TTL high level.</p> <ul style="list-style-type: none"> • For AM, FM, PM and PWM, the frequency of the sync signal is the modulation frequency. • For ASK, FSK, and PSK, the frequency of the sync signal is the modulation rate. • For SUM, the frequency of the sync signal is the SUM frequency.

Output Mode	Descriptions
	<p>TIP</p> <p>The sync output is disabled when the channel uses external modulation.</p>
Sweep Mode	<p>Sweep Internal Trigger Period = 1 ms + Start Hold Time + Sweep Time + Stop Hold Time + Return Time.</p> <ul style="list-style-type: none"> • Sync mode set to "Normal": When the sweep time starts, the sync signal goes high from a TTL low level and goes low again at the end of the sweep total time. • Sync mode set to "Mark": When the sweep time starts, the sync signal goes high from a TTL low level and goes low again at the mark frequency. For step sweeps, if the mark frequency is not equal to any of the sweep point values, the sync signal becomes a low level at the sweep point which is less than and closest to the mark frequency when sweeping from high frequency to low frequency or at the sweep point which is greater than and closest to the mark frequency when sweeping from low frequency to high frequency. <p>TIP</p> <p>The sync output is disabled when the channel uses the external trigger source.</p>
Burst Mode	<ul style="list-style-type: none"> • Infinite N-Cycle Burst: The sync signal is at a high level for the burst output. • User-defined N-Cycle Burst: The sync signal is a TTL high level at the beginning of the burst. It becomes a TTL low level after a specified number of cycles is completed. When the internal trigger source is selected, the sync signal frequency is the reciprocal of the burst period. Duty cycle is carrier period*cycles/burst period. • Gated Burst: There is no sync signal output. <p>TIP</p> <p>The sync output is disabled when the channel uses the external trigger source.</p>
Advanced Mode	<p>In Advanced mode, the sync signal of the Arb waveform is a square wave with 50% duty cycle, and the frequency of the sync signal is sample rate/waveform points.</p>

12.2 Trigger Output Setup

In Burst or Sweep mode, when the trigger source is set to "Internal" or "Manual", the generator outputs a TTL-compatible signal with the specified edge via the front-panel **[Sync Out]** connector.



NOTE

- In internal trigger, the generator outputs a square waveform with 50% duty cycle via the front-panel **[Sync Out]** connector at the beginning of the burst/sweep.
- In manual trigger, the generator outputs a pulse with greater than 4 μ s pulse width via the **[Sync Out]** connector at the beginning of the burst/sweep.
- When the trigger source is set to External, the trigger output is disabled. When the sync output is enabled, the trigger output is disabled automatically.

Click or tap the **Trig Out** on/off switch to enable or disable the trigger output function. When the trigger output is enabled, you can specify the edge of the trigger output signal.

- Leading: outputs the trigger signal of the leading edge.
- Trailing: outputs the trigger signal of the trailing edge.

12.3 Channel Output Setup

Enable/Disable the Channel Output

You can enable/disable the channel output in the following ways.

- When the output type is set to differential, press the front-panel channel on/off key to enable or disable the corresponding channel output. When the output type is set to single-ended, after selecting the specified channel, press the front-panel channel selection key to enable or disable the corresponding channel output (2-channel models: CH1/CH2; 4-channel models: CH1/CH2/CH3/CH4) or the front-panel channel on/off key to enable or disable the corresponding channel output (2-channel models: CH3/CH4; 4-channel models: CH5/CH6/CH7/CH8).
- Press the front-panel  key to turn on/off the outputs of all channels simultaneously.
- Click or tap the channel identifier at the left side of the parameter configuration area.
- Drag the channel label up to enable the output of the corresponding channel or drag the channel label down to disable the output of the corresponding channel.

Output Polarity

You can use either the normal mode or invert mode to output signals. In the Channel Setup Interface, click or tap the **Invert** on/off switch to enable or disable the invert function. The default is "Off".

The waveform is inverted relative to the offset voltage. As shown in the figure below, relative to the offset voltage, the waveform is inverted.

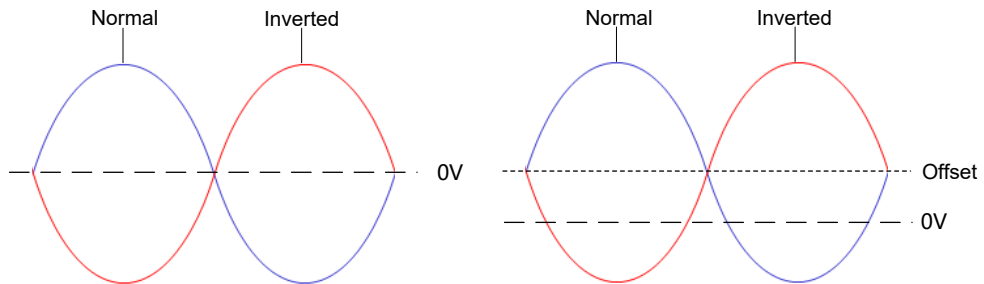

TIP

- Setting the waveform invert does not invert the sync signals related to the waveform. To invert the sync signal, refer to *Sync Polarity*. Set the polarity of the sync signal to "negative".
- The offset voltage remains unchanged when the waveform is inverted.

Output Impedance

The output impedance setting affects the output amplitude range and DC offset. This instrument has a fixed series output impedance of 50 Ω to the front-panel BNC output connector. If the actual load impedance differs from the value specified, the voltage level displayed would not match the voltage level of the device under test. To ensure correct voltage level, the load impedance setting must match the actual load.

When the output type is set to single-ended, click or tap **Imped** drop-down button in the Channel Setup Interface to select "HighZ" or "Load". If "Load" is selected, you can click or tap the **Imped** input field to define the impedance. The range is from 1 Ω to 10 k Ω .



NOTE

- After that, the instrument will adjust the output amplitude range and offset voltage automatically. For example, the current amplitude range is 5 Vpp. At this point, change the output impedance from 50 Ω to HighZ and the amplitude range displayed in the input field will be doubled to 10 Vpp. If the output impedance is changed from HighZ to 50 Ω , the amplitude range will be reduced to half of the previous value (2.5 Vpp). Note that only the displayed values change with the parameter and the actual output from the generator does not change.
- If the impedance is set to "HighZ", the amplitude unit cannot be set to "dBm".
- When the output type is set to differential, or when the output type is single-ended and IQ modulation is enabled, the impedance is fixed to "Load" and cannot be modified.

Debounce Function

When the output of the generator is enabled before the relay has fully settled, initiating the DDS output may result in high-frequency ringing on the signal edges, impacting the test stability.

This instrument provides the debounce function. Click or tap the **Debounce** on/off switch to enable or disable the debounce function. When the debounce function is disabled, the DDS begins outputting the target waveform immediately after the output enable command is issued. If the relay has not fully settled at this point, ringing may occur. When the debounce function is enabled, the corresponding channel first closes the relay (establishing the output path), and after it has stabilized, the DDS then starts outputting the target waveform. This mechanism effectively suppresses ringing in the output waveform.



TIP

- When the output type is differential and the debounce function is enabled, as the two differential terminals are inverted in real time, a level segment will exist before the differential waveform output when the offset is not zero.
- The debounce function is enabled by default, and its status is not affected by the operation of restoring the default value or loading the configuration file.
- When the debounce function is enabled, there will be a period of idle level output before the target signal is output. The rules are as follows:
 - For the square wave with the fast transition enabled, the idle level is fixed to the low level of the square wave.
 - For Burst and Multi-pulse waveforms, the idle level will follow the idle level settings specified in their respective functions.
 - For waveforms other than Burst, Multi-pulse, and Square (fast transition enabled), when the low level is greater than 0 V, the idle level is the low level of the waveform. When the high level is less than 0 V, the idle level is the high level of the waveform. When the low level is less than or equal to 0 V and the high level is greater than or equal to 0 V, the idle level is 0 V.

Note that when the fast transition is enabled, the idle level is fixed to the low level of the square wave.

Channel-to-channel Skew

Channel-to-channel skew is used to control the time difference between multiple output channels for multi-channel synchronization. You can adjust the relative timing of the signal output precisely by setting the delay time for different channels.

In the Channel Setup Interface, click or tap the **Skew** input field to set the channel-to-channel skew. The range is from -200 ns to 200 ns.



TIP

- The actual effective precision of the channel-to-channel skew is 400 ps.

- The channel skew is not affected by the operation of restoring the default value or loading the configuration file.

13 Channel Copy

DG6000 provides the Channel Copy function. It allows you to copy the states and waveform parameters of one channel (source channel) to the other channel (target channel), minimizing repetitive operations in multi-channel configurations. Refer to the following table ([Table 13.1 Multi-channel Operation Parameters](#)) for parameters that can be copied.

Click or tap **Channel Copy** at the bottom of the screen to open the Channel Copy Menu, as shown in the figure below. Click or tap the channel selection drop-down buttons to select the source channel and the target channel respectively. For example, CH1→CH2 indicates selecting CH1 as the source channel and CH2 as the target channel. After that, click or tap **Apply** to copy the states and waveform parameters of the source channel to the target channel.

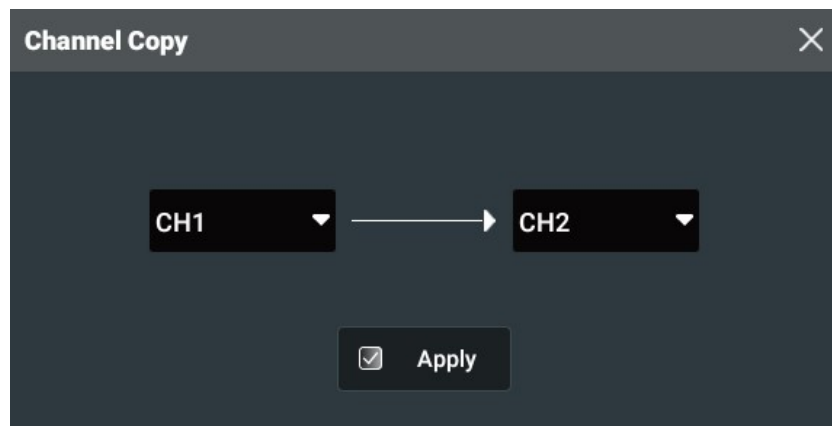

Figure 13.1 Channel Copy Menu



TIP

- If a channel's output mode is set to Advanced or the channel track function is enabled, it cannot be used as the source channel for the channel copy function.
- If a channel is set as the benchmark channel of the Bundled Channels or has channel track or coupling function enabled, it cannot be used as the target channel for the channel copy function. For how to configure the Bundled Channels, please refer to [Bundle By Source Setup](#).
- For 2-channel models, you can only copy from the benchmark channel to the other channel when the output type is set to differential.

Table 13.1 Multi-channel Operation Parameters

(√ indicates available; × indicates not available)

Parameter	Track	Copy
Basic Functions		
Channel On/Off Status	×	×

Parameter	Track	Copy
Output Mode	√	√
Basic Waveform	√	√
Frequency Display Mode	√	√
Frequency Value	√	√
Frequency Coupling	Disabled	Not available when Coupling is on
Period	√	√
Amplitude Range Display Mode	√	√
Amplitude Range Value	√	√
Amplitude Range Unit	√	√
Amplitude Coupling	Disabled	Not available when Coupling is on
Offset	√	√
High Level	√	√
Low Level	√	√
Phase	√	√
Phase Coupling	Disabled	Not available when Coupling is on
Square Duty Cycle	√	√
Square Fast Transition On/Off	√	√
Square Transition Time	√	√
Ramp Symmetry	√	√
Pulse Width Display Mode	√	√
Pulse Width	√	√
Pulse Duty Cycle	√	√
Rising Edge	√	√
Trailing Edge	√	√
Built-in Arb Type	√	√
Harmonic Type	√	√
Harmonic Order	√	√
Harmonic Combination	√	√
Order Harmonic Amplitude	√	√
Order Harmonic Phase	√	√
Combine Harmonic Amplitude List	√	√
Combine Harmonic Phase List	√	√
Burst		
State	√	√
Mode	√	√
(Trigger) Source	√	√
Burst Delay	√	√
Cycles	√	√

Parameter	Track	Copy
Burst Period	√	√
Phase	√	√
Gated Polarity	√	√
Idle Level	√	√
Sweep		
State	√	√
Mode	√	√
(Trigger) Source	√	√
Frequency Display Mode	√	√
Start Frequency	√	√
Stop Frequency	√	√
Center Frequency	√	√
Frequency Span	√	√
No. of Steps	√	√
Start Hold Time	√	√
Stop Hold Time	√	√
Sweep Time	√	√
Return Time	√	√
Mark Frequency	√	√
Modulation		
State	√	√
Modulation Type	√	√
Modulation Source	√	√
Modulating Waveform	√	√
Modulation Frequency	√	√
Modulation Depth	√	√
DSSC	√	√
Frequency Deviation	√	√
Phase Deviation	√	√
Duty Cycle Deviation/Width Deviation Display	√	√
Duty Cycle Deviation	√	√
Width Deviation	√	√
Modulation Rate	√	√
Modulation Port	√	√
Modulation Polarity	√	√
Modulation Amplitude	√	√
Hop Frequency	√	√
Phase	√	√
SUM Waveform	√	√
SUM Frequency	√	√
SUM Ratio	√	√

Parameter	Track	Copy
Channel		
Sync On/Off	√	×
Sync Mode	√	×
Sync Polarity	√	×
Trigger Output On/Off	√	√
Trigger Output Edge	√	√
Invert	√	×
Impedance	√	√
Channel Skew	√	√
Debounce	×	×

14 Bundle By Source Setup

DG6000 supports the Bundle By Source function. The *Align Phase* operation takes effect for all channels that have been added to the Bundled Channels. You can also set the coupling and track functions for channels added to the Bundled Channels. The coupling or track function allows you to pass parameters from one channel to the

other according to your requirements. Click or tap  > **Bundle By Source** to open the Bundle By Source Menu, as shown in the figure below.

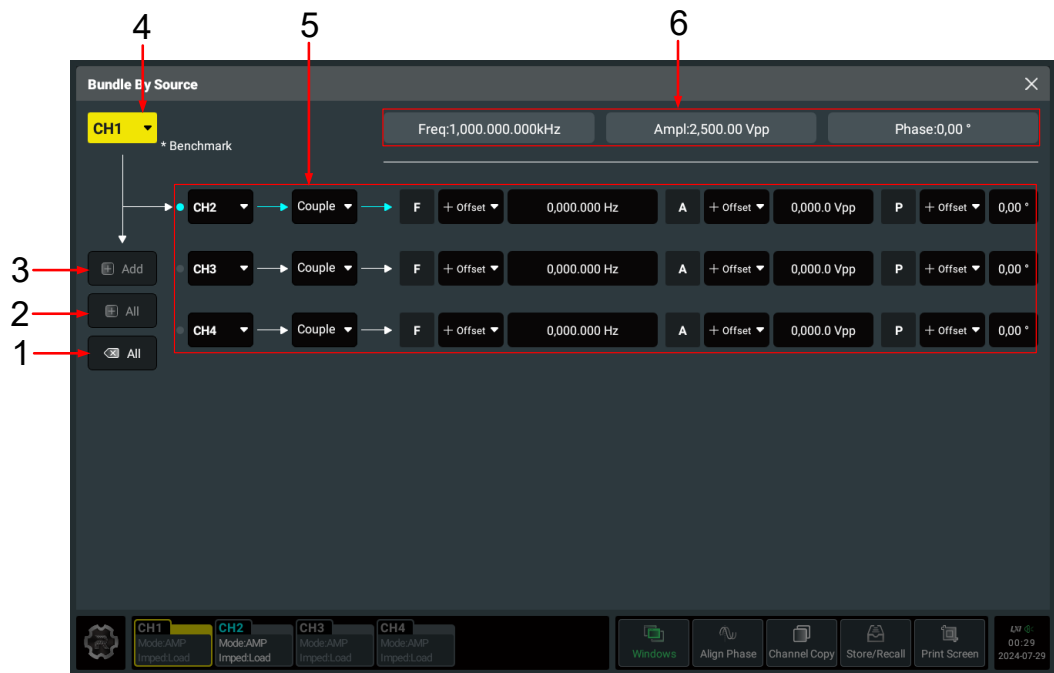

Figure 14.1 Bundle By Source Menu

1. Clear key. If multiple channels have been added to the Bundled Channels, you can click or tap this key to delete all channels (except the benchmark channel).
2. All Channel Add Key. Click or tap this key to add all channels to the Bundled Channels (the benchmark channel is added automatically).
3. Channel Add Key. Click or tap this key and a channel selection menu will be displayed. You can select a channel to add to the Bundled Channels.
4. Benchmark Channel Drop-down Button. Displays the current benchmark channel. You can click or tap the drop-down button to select the specified channel to add to the Bundled Channels and serve as the benchmark channel for the Bundled Channels. Note that switching the benchmark channel turns off the track and coupling functions currently enabled and clears channels other than the benchmark channel in the Bundled Channels.

5. Bundled Channels Setup Area. Displays all target channels that have been added to the Bundled Channels. You can set the coupling and track parameters in this area.
6. Benchmark Channel Parameter Preview. Displays the frequency, amplitude range, and phase parameters of the benchmark channel in real time.

**TIP**

- When a channel is removed from the Bundled Channels, the coupling or track function for that channel is automatically turned off.
- When a channel is added to the Bundled Channels Setup Area, you can also click or tap any channel drop-down button in the area. In the pop-up menu, you can either switch the channel to add to the Bundled Channels or select **Delete** to remove the current channel from the Bundled Channels.

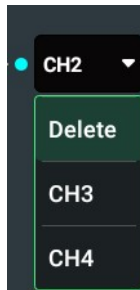

14.1 Coupling Setup

DG6000 supports frequency, amplitude range, and phase coupling. When the Coupling function is enabled, if the frequency, amplitude range, or phase of one channel is changed, the parameter of other coupled channels will be adjusted automatically based on the preset offset or ratio.

In the Bundle By Source Menu, click or tap the Coupling/Track drop-down button to select "Couple". The Coupling Setup Interface is as shown in the figure below (taking adding CH2 as an example).

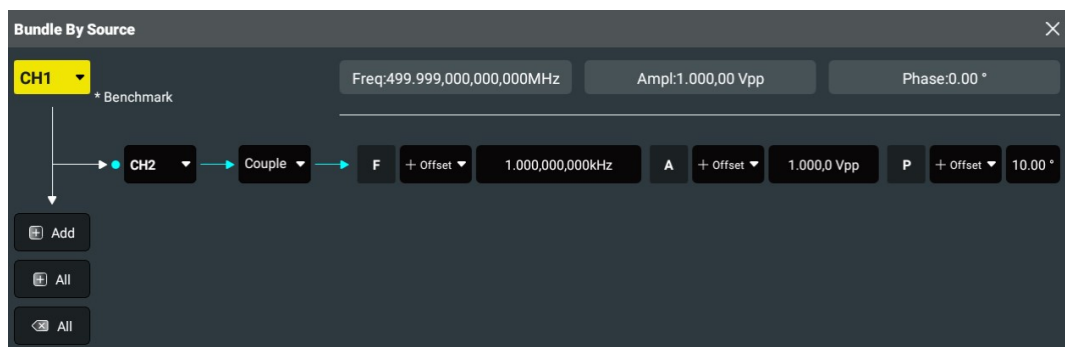

Figure 14.2 Coupling Setup Interface

**NOTE**

The Coupling function is available only when the output mode of both the benchmark channel and the target channel is set to "Continuous". The following table shows the relationship between the coupling mode and the waveform shape.

(√ indicates available; × indicates not available)

Coupling Function	Sine	Square	Ramp	Pulse	Noise	Arb	DC	Harmonic
Frequency Coupling	√	√	√	×	×	×	×	×
Amplitude Range Coupling	√	√	√	×	√	√	×	×
Phase Coupling	√	√	√	×	×	×	×	×

Frequency Coupling (F)

Frequency coupling allows you to couple frequencies between channels, either by a constant offset or ratio between them.

1. Click or tap the **F** drop-down button to select offset or ratio for the frequency coupling.
2. When "Offset" or "Ratio" is selected for the frequency coupling, click or tap the **F** input field to set the offset or ratio.
 - Offset: the frequency offset between the coupled channel and the benchmark channel. Set the frequency of the benchmark channel to F_{basic} and the frequency offset of a coupled channel to F_{offs} , then the frequency of the coupled channel is $F = F_{\text{basic}} + F_{\text{offs}}$.
 - Ratio: frequency ratio of the coupled channel to the benchmark channel. Set the frequency of the benchmark channel to F_{basic} and the frequency ratio of a coupled channel to F_{ratio} , then the frequency of the coupled channel is $F = F_{\text{basic}} * F_{\text{ratio}}$. The ratio ranges from 0.001 to 1000.
3. In the Coupling Setup Interface, click or tap **F** to enable or disable the frequency coupling function for the specified channel. When the function is enabled, **F** is highlighted.

Amplitude Range Coupling (A)



Amplitude range coupling allows you to couple amplitude ranges between channels, either by a constant offset or ratio between them.

1. Click or tap the **A** drop-down button to select offset or ratio for the amplitude range coupling.
2. When "Offset" or "Ratio" is selected for the amplitude range coupling, click or tap the **A** input field to set the offset or ratio.
 - Offset: the amplitude range offset between the coupled channel and the benchmark channel. Set the amplitude range of the benchmark channel to A_{basic} and the amplitude range offset of a coupled channel to A_{offs} , then the amplitude range of the coupled channel is $A = A_{\text{basic}} + A_{\text{offs}}$.
 - Ratio: amplitude range ratio of the coupled channel to the benchmark channel. Set the amplitude range of benchmark channel to A_{basic} and the amplitude range ratio of a coupled channel to A_{ratio} , then the amplitude range of the coupled channel is $A = A_{\text{basic}} * A_{\text{ratio}}$. Amplitude range ratio ranges from 0.001 to 1000. For HBW output, the amplitude range ratio is limited by the maximum and minimum amplitude ranges and is from 0.2 to 5.
3. In the Coupling Setup Interface, click or tap **A** to enable or disable the amplitude range coupling function for the specified channel. When the function is enabled, **A** is highlighted.



NOTE

In various output states, the amplitude range offset is converted and set according to the Vpp value in the HighZ state. Since the impedance is fixed at 50 Ω for AMP and HBW outputs, the actual displayed offset value is half of the offset setting value. For example, when the amplitude range of the benchmark channel is 1 V and the offset value of the amplitude range is +1 V, the amplitude range of the coupled channel is actually displayed as 1.5 V.

Phase Coupling (P)

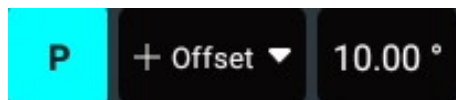

Phase coupling allows you to couple phases between channels, either by a constant offset or ratio between them.

1. Click or tap the **P** drop-down button to select offset or ratio for the phase coupling.

2. When "Offset" or "Ratio" is selected for the phase coupling, click or tap the **P** input field to set the offset or ratio.

- Offset: the phase offset between the coupled channel and the benchmark channel. Set the phase of the benchmark channel to P_{basic} and the phase offset of a coupled channel to P_{offs} , then the phase of the coupled channel is $P = P_{\text{basic}} + P_{\text{offs}}$.
- Ratio: phase ratio of the coupled channel to the benchmark channel. Set the phase of the benchmark channel to P_{basic} and the phase ratio of a coupled channel to P_{ratio} , then the phase of the coupled channel is $P = P_{\text{basic}} * P_{\text{ratio}}$. The ratio ranges from 0.01 to 100.

3. In the Coupling Setup Interface, click or tap **P** to enable or disable the phase coupling function for the specified channel. When the function is enabled, **P** is highlighted.



TIP

- When the Coupling function is enabled, if the frequency, amplitude range, or phase of the coupled channel exceeds the upper/lower limit after calculation according to the ratio or offset, the generator will automatically adjust the waveform parameters of the benchmark channel to avoid parameter overlimit of the benchmark channel and other channels with the coupling/track function enabled. If the adjusted waveform parameters will still exceed the limit, then this ratio or offset is not allowed.
- When the Coupling function is enabled, if parameter overlimit occurs due to waveform switching or parameter adjustments, the system automatically turns off the corresponding coupling switch.
- When the Coupling function is disabled, it cannot be enabled if the coupling parameter exceeds the limit.
- When the Track function is enabled, the Coupling function of the channel is disabled. When the Coupling function is enabled, the channel cannot be used as the target channel for the channel copy function.

14.2 Track Setup

When the Track function is enabled, the parameters of the benchmark channel (see [Table 13.1 Multi-channel Operation Parameters](#)) are copied to the track channel in real time while the track channel cannot be operated (except the channel on/off status) at this point. The modifications to the benchmark channel also apply to the track channel. The Track function makes it easier to configure the same parameters for multiple channels.

In the Bundle By Source Menu, click or tap the Coupling/Track drop-down button to select "Track". The Channel Track Setup Interface is as shown in the figure below (taking adding CH2 as an example).

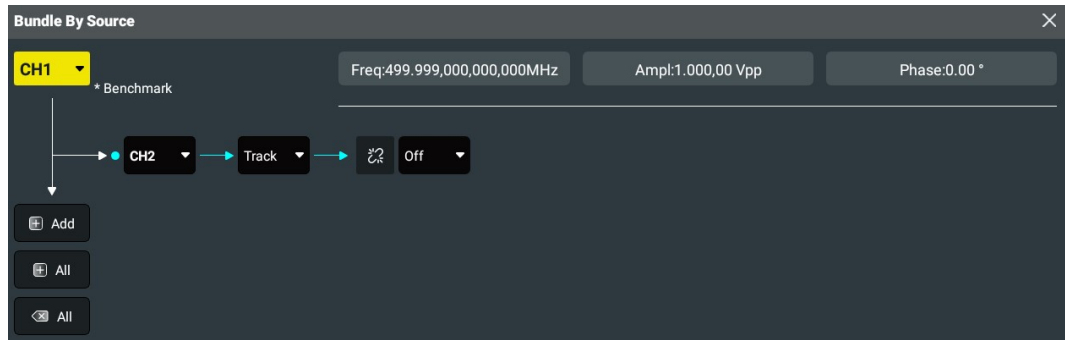

Figure 14.3 Channel Track Setup Interface

In the interface as shown in the figure above, you can click or tap the track status icon to enable or disable the Track function. You can also click or tap the drop-down button to select "On", "Inverted", or "Off" for the Track function. When "On" or "Inverted" is selected, the track status icon is highlighted.

- **On** (🔗): enables the Track function. When the Track function is enabled for the specified channel, the instrument automatically copies the parameters and states (except the channel output on/off state) of the benchmark channel to the channel. When the parameters and states of the benchmark channel are modified, the modifications also apply to target channel. In this way, the benchmark channel and the target channel can output identical signals (output enabled).
- **Inverted** (🔗_{inv}): The Track function is enabled, but the target channel and the benchmark channel have opposite output polarities.

Note that Enabling the "Inverted" function automatically adjusts the "Invert" on/off of the target channel. After disabling the Track function, you need to modify the "Invert" on/off setting of the target channel.

- **Off** (🔗_{off}): disables the Track function. It is the default setting.

TIP

- When the coupling mode (*Coupling Setup*) is enabled, enabling the Track function automatically disables the channel coupling function.
- When the output mode of the benchmark channel is set to "Advanced", the Track function is disabled.



15 Align Phase

DG6000 provides the Align Phase function. Click or tap the **Align Phase** key or press the front-panel **Align** key. The instrument will adjust the phase settings of all channels added to the Bundled Channels and set an internal zero-phase reference point. The align phase function is not available for channels which select external/manual trigger or external modulation. If any channel of the Bundled Channels has the state mentioned above with its output enabled, then the align phase operation will be invalid. You have to remove the channel from the Bundled Channels or modify the channel state before performing the align phase operation. For how to add channels to the Bundled Channels or remove the channels from the Bundled Channels, refer to *Bundle By Source Setup*.

For multiple signals whose frequencies are identical or in multiple, you can use this function to align their phases. For example, the instrument outputs a sine waveform (1 kHz, 5 Vpp) with 0° phase from CH1 and a sine waveform (1 kHz, 5 Vpp) with 180° phase from CH2. Use an oscilloscope to acquire waveforms from two channels and then display the acquired two waveforms. You will see that the waveforms shown on the oscilloscope do not always have a phase deviation of 180° . At this point, click or tap the **Align Phase** key. The waveforms shown on the oscilloscope will have a phase deviation of 180° without any adjustment of the start phase of the generator.

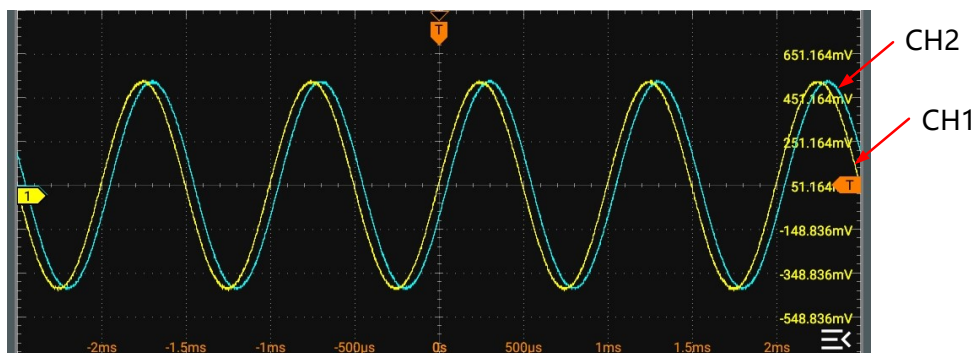

Figure 15.1 Before Aligning Phase

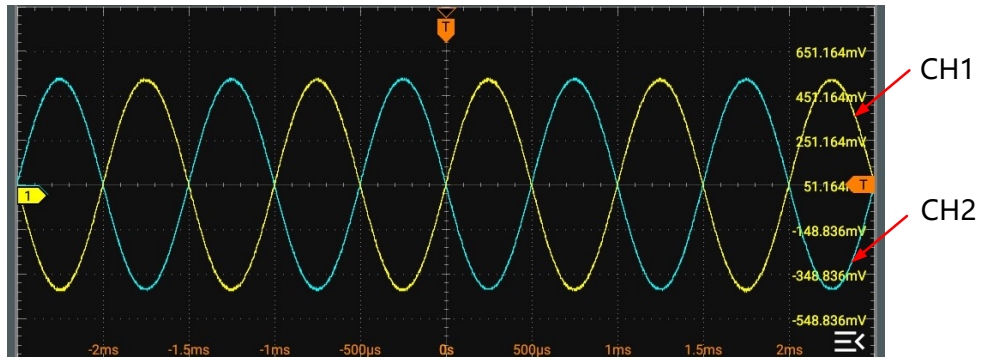



Figure 15.2 After Aligning Phase

16 Storage Management

You can store the screen capture, self-defined sequences and waveforms to the internal memory or external storage device. This series provides a USB HOST interface on the front panel used to connect the USB storage device for external storage. The local directory is "Local Disk (C)" and the external storage device is displayed as "USB Disk (D)".

You can access the "Store" menu in the following ways.

- Click or tap **Store/Recall** at the bottom of the interface to enter the "Store" menu.
- Press the front-panel  key to enter the "Store" menu.



TIP

This instrument can only identify the file whose name contains English letters (including numbers and underscores). The file or folder named by Chinese characters or other characters cannot appear in the storage menu.

16.1 To Select the File

You need to select the desired file/folder(s) before any further operation.

1. Select the Disk

By default, the menu displays the content of "Local Disk(C)". You can switch to the external storage device in the drop-down menu at the upper-left side of the menu. For example, after "USB Disk(D)" is selected, the menu will display the content of the external storage device-D disk.



TIP

Before using the external storage device, please make sure that the USB storage device (FAT32, NTFS or exFAT format) is properly connected.

2. Enter the Target Directory

Click or tap the folder to enter the target directory.

3. Select the File/Folder

Tick the check box next to the file or folder and the box will be displayed as . You can click or tap the box again to cancel the selection. The check box restores to its original state.



TIP

You can also tick the icon at the upper-right side of the menu to select all the files and folders under the current directory. Click or tap  again to cancel the select-all operation.

16.2 To Transfer Files with FTP

Apart from using the USB storage device, you can also use the File Transfer Protocol (FTP) to connect DG6000 to your PC, transferring files in either direction. You can also use the File Explorer of the PC or dedicated FTP transfer software to transfer files. For more stable transmission, it is recommended to use the FTP software. This section takes the Xftp 8 software as an example to illustrate how to transfer files between DG6000 and PC.

Preparations

1. Make sure that the Xftp 8 has been installed on your PC. If not, please visit the official website of the software to download and install it.
2. Make sure that your DG6000 is connected to the LAN. Click or tap  > **Utility** > **I/O** and check the IP address of the instrument from the **IP Address** item.

File Transfer Procedures

1. Create session.

Open the installed Xftp 8 software. Click **File** > **New** and the "Properties of New Session" dialog box is displayed. Configure the following properties and then click **OK** to create a new session.

- Host: Enter the IP address of DG6000.
- Protocol: Select FTP.
- User Name/Password: Enter the user name and password of DG6000. The user name is "admin" and the password is "rigol" by default.

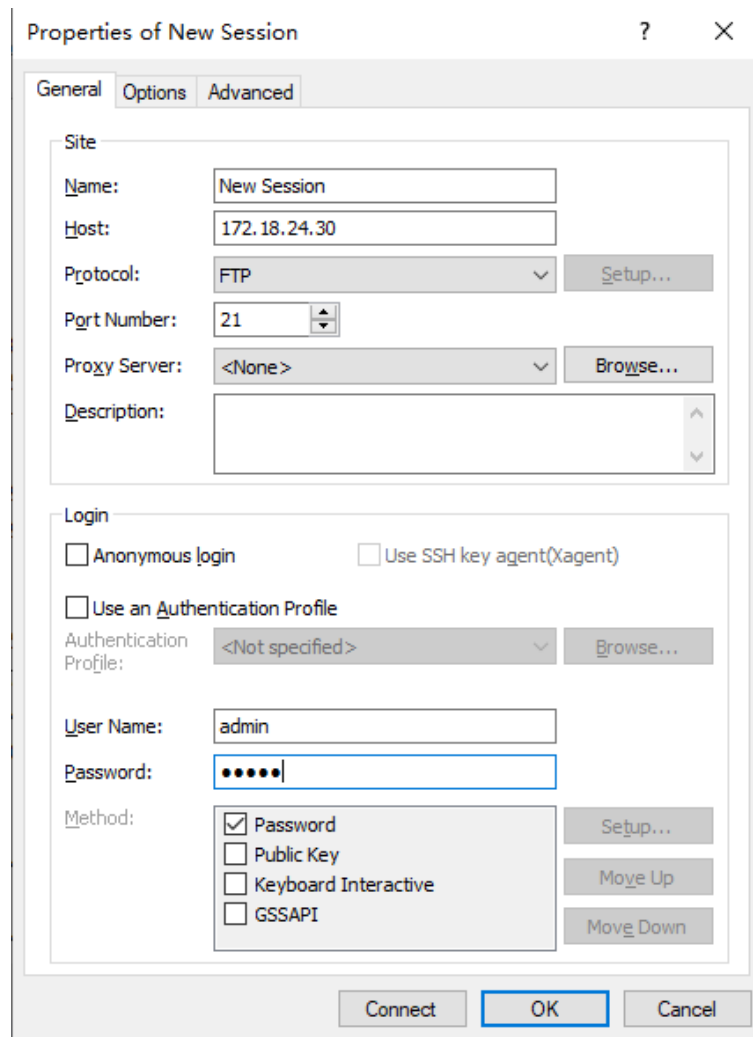

Figure 16.1 Create Session

2. Make connection.

Select the new session and click **Connect**. After connection, you can browse files on your local computer and DG6000 in the Xftp 8 interface.

3. Transfer file.

Drag the selected files from a window to another to upload and download the files between the PC and DG6000.

4. Disconnect.

After the file transfer is complete, you can close the session to disconnect from DG6000.



TIP

You can also use other software to transfer files. For details, see the user manual of the corresponding software.

16.3 To Create New Folder

You can create new folders in the menu. Click or tap **New directory** at the bottom of the menu and set the folder name (Chinese characters not supported) with the pop-up virtual keypad. A new folder will be created under the current path with the file name.

16.4 Cut and Copy

Cut a File to a Specified Directory

Select a specified file. Click or tap **Cut** and then access the target directory. Click or tap **Paste** to complete the operation.

Copy a File to a Specified Directory

Select a specified file. Click or tap **Copy** and then access the target directory. Click or tap **Paste** to complete the operation.

16.5 Rename

Select a specified file. Click or tap **Rename** and set the name with the pop-up virtual keypad. DG6000 does not support Chinese characters.

16.6 Delete

Under the current directory, select the file or folder (empty) that you want to delete. Click or tap **Delete** to delete the selected file or folder. You cannot delete folders that are not empty.



17 Upgrade

You can upgrade the system following the steps below.

1. Ensure that the USB device is correctly connected to the instrument.
2. Then click or tap **Store/Recall** at the bottom of the interface or press the front-panel  key to enter the "Store" menu.
3. Refer to *Storage Management*. Select the upgrade file and then click or tap **Upgrade**. In the pop-up menu, click or tap **OK** to perform the local upgrade operation.

18 System Utility Function Setting

In the "Utility" menu, you can set the I/O parameters and the system-related function parameters. To enter the "Utility" menu, perform the following operations.

- Click or tap the notification area at the lower-right corner of the interface to enter the "Utility" menu.
- Press the front-panel  key to enter the "Utility" menu.
- Click or tap the function navigation icon  at the lower-left corner of the interface, and then select **Utility** to enter the "Utility" menu.

18.1 I/O Setting

In the **Utility** menu, click or tap **I/O** to enter the I/O setting menu to configure the following parameters.

Network Status

Different prompts will be displayed according to the current network connection status.

- Network Config Succeeded!
- Acquiring IP..
- IP Conflict!
- DISCONNECTED!
- DHCP Config Failed
- Read Status Fail!
- CONNECTED
- Invalid IP
- IP lost
- Please wait...

IP Configuration Type

The configuration type of the IP address can be DHCP, Auto IP, or Static IP. In different IP configuration types, the configurations for IP address and other network parameters are different.

- **DHCP**

If "DHCP" is selected, the DHCP server in the current network will assign the network parameters (e.g. IP address, Subnet, Gateway, and DNS) for the instrument.

- **Auto IP**

When "Auto IP" is selected, the instrument will acquire the IP address ranging from "169.254.0.1" to "169.254.255.254" and the subnet mask (255.255.0.0) automatically based on the current network configuration. The "Auto IP" works only when "DHCP" is not selected or connection is failed.

- **Static IP**

If "Static IP" is selected, the instrument is configured with static IP. In this case, you need to disable DHCP and Auto IP manually. Then you need to configure the parameters such as "IP address", "Subnet", "Gateway", and "DNS" manually. At this time, you can self-define the network parameters (e.g. IP address) of the instrument.

- **Set the IP address**

The format of the IP address is nnn.nnn.nnn.nnn. The range of the first segment (nnn) of the address is from 0 to 255 (except 127); wherein, the valid range is from 0 to 223. The range for the other three segments is from 0 to 255. You are recommended to ask your network administrator for an IP address available.

- **Set the subnet mask**

The format of the subnet mask is nnn.nnn.nnn.nnn. Wherein, the range of "nnn" is from 0 to 255. You are recommended to ask your network administrator for a subnet mask available.

- **Set the default gateway**

You can set this parameter in Static IP mode. The format of the gateway is nnn.nnn.nnn.nnn. The range of the first segment (nnn) is from 0 to 223 (except 127), and the range for the other three segments is from 0 to 255. You are recommended to ask your network administrator for a gate address available.

- **Set the DNS address**

You can set this parameter in Static IP mode. The format of the DNS address is "nnn.nnn.nnn.nnn". The range for the first segment (nnn) of the address is from 0 to 223 (except 127); and the range for the other three segments is from 0 to 255. You are recommended to ask your network administrator for an address available.

Generally, you do not need to set the DNS, therefore this parameter setting can be ignored.

**TIP**

- When the three IP configuration types are all turned on, the priority of the parameter configuration from high to low is "DHCP", "Auto IP", and "Static IP".
- The three IP configuration types cannot be all turned off at the same time.

MAC Address

Displays the MAC address by the instrument. For each instrument, the MAC address is unique. When assigning the IP address for the instrument, the system uses the MAC address to identify the instrument.

VISA Address

Displays the VISA address currently used by the instrument.

Reset the Network Parameter Setting

Click or tap **Reset** to cancel the current parameter setting and restore it to the default setting.

Apply the Network Parameter Setting

Click or tap **Apply** to validate the current network parameter setting.

18.2 LXI

In the **Utility** menu, click or tap **LXI** to enter the LXI setting menu and configure the following parameters.

mDNS

Click or tap the mDNS on/off switch to enable or disable the multicast Domain Name System (mDNS). This system is used to provide the function of DNS server for service discovery in a small network without a DNS server.

Host Name

Click or tap the **Host Name** input field to set the host name. A maximum of 28-byte strings can be supported. When mDNS is enabled, you can also input "hostname.local" into the browser address bar to access Web Control.

Service Name

After the mDNS function is enabled, click or tap the **Service Name** input field to set the service name.

18.3 Basic Settings

In the **Utility** menu, click or tap **Setup** to access the basic setting menu.

Language

This instrument supports help information, prompt message, and interface display in Simplified Chinese, Traditional Chinese, and English. Click or tap the drop-down button of **Language** to select the specified system language.

Load Last

You can set the system configuration to be recalled when the instrument is powered on again after power-off. Click or tap the **Load Last** drop-down button to select "Default" or "Last". The default setting is "Last".

- **Last:** returns to the setting of the system at last power-off.
- **Default:** returns to the factory setting of the system.

Power Setting

Click or tap the **Power Set** drop-down button to select "Auto" or "Manual".

- **Manual:** After the instrument is connected to power, you need to press the power key to power on the instrument.
- **Auto:** After the instrument is connected to power, it will be powered on immediately.

This setting is stored in the non-volatile memory. It is not affected by the "restore factory defaults" operation.

Clock Source

This series generator provides an internal clock source (10 MHz) and accepts the external clock source from the rear-panel **[10 MHZ REF IN]** connector. It also outputs the clock source via the **[10 MHZ REF OUT]** connector for the use of other equipment. Click or tap the **Clk Src** drop-down button to select "Internal" or "External". The default setting is "Internal".

When "External" is selected, the instrument will continue to output if no valid signal is applied to the rear-panel **[10 MHZ REF IN]** connector, but the output frequency is unstable.

CAUTION

When using an external source, it is necessary to first connect a valid external 10 MHz clock and then set the **Clk Src** to "External"; otherwise, it may cause abnormal waveform output.

TIP

You can synchronize two or more instruments by setting the clock source.



Number Format

You can set the display format of the decimal point and thousands separator in number parameters. This setting is stored in the non-volatile memory. It is not affected by the "restore factory defaults" operation.

- **Decimal Point:** click or tap the **Decimal** drop-down button to select "." or ",". The default setting is ".".
- **Thousands Separator:** click or tap the **Separator** drop-down button to select ".", ",", "Space", or "None". They cannot be set to "." or "," at the same time.

Brightness

Click or tap the **Brightness** input field to set the brightness of the display.

Trigger Level



Click or tap the **Trig Level** input field to set the valid trigger level. The range is from -8 V to 8 V. A valid trigger event occurs when the input trigger signal crosses the trigger level from below to above (rising edge trigger) or from above to below (falling edge trigger).

Beeper

Click or tap the **Beeper** on/off switch to turn on or off the beeper. When it is on, you can hear the beeper sound when operating the instrument or an error occurs.

Date and Time

Click or tap the **Show Time** on/off switch to turn on/off showing the date and time on the screen. When it is on, the system time is displayed in "hh:mm" format, and the date is displayed in "yyyy-mm-dd" format in the Notification Area at the lower-right corner of the screen. You can self-define the system date and time.

- **Date:** click or tap the **Date** input field and the date setting menu is displayed. Adjust the date and then click or tap **OK** to complete the date setting.
Otherwise, click or tap  to close the menu and cancel the modifications.
- **Time:** click or tap the **Time** input field and the time setting menu is displayed. Adjust the time and then click or tap **OK** to complete the time setting.
Otherwise, click or tap  to close the menu and cancel the modifications.

18.4 About this Instrument

In **Utility** menu, click or tap **About**, and then you can view the model, version, and other information about this instrument.

- **Device Model**
Indicates the product model.

- **Serial number**
Indicates the serial number of the product, the unique identification for the product.
- **Calibration Date**
Indicates the last calibration date.
- **Analog Hardware Version**
Indicates the analog hardware version number of the product.
- **Digital Hardware Version**
Indicates the digital hardware version number of the product.
- **Main Board Version**
Indicates the version number of the main board.
- **Sub Card Version**
Indicates the version number of the daughter card.
- **FGen Subsystem Version**
Indicates the function generator version number.
- **UI Subsystem Version**
Indicates the user interface version number.
- **WebServer Subsystem Version**
Indicates the version number of the network service system.
- **Runtime System Version**
Indicates the version number of the operation system.

18.5 Print Screen

You can capture the current screen and save the image to the memory in different formats. In the **Utility** menu, click or tap **Print Screen** to enter the print screen setting menu. You can set the image format to "BMP" or "PNG".

Then click or tap the **Print Screen** button at the bottom of the interface. The screen image will be stored in the specified format. By default, the screen capture is saved to internal memory.

18.6 Option

In **Utility** menu, click or tap **Options** to view the option installation information. To install options, please refer to *To View the Option Information and the Option Installation*.

18.7 Open Source Acknowledgment

In the **Utility** menu, click or tap **Open Source** to view the open source acknowledgment of this series in the pop-up window.

18.8 Self-check

In **Utility** menu, click or tap **Self Check** to enter the "Self Check" menu. You can test the following self-check items for the device.

Key Test

Click or tap **Key Test** to enter the key test interface (virtual front-panel key).

At this time, you can press the front-panel keys to check whether the virtual keys are highlighted. If yes, it indicates that the keys work normally; if no, it indicates that there's something wrong with the keys. Click or tap **Exit** at the lower-right corner of the interface to exit the key test interface.

Touch Test

Click or tap **Touch Test** to enter the touch screen test interface.

Slide with your finger on the screen. If there is a line displaying at the empty area where you slide on the screen and the box that you tap turns out to be filled with green background, it indicates that the touch function of this area is normal. Click or tap **Exit** at the lower-left corner of the interface to exit the touch screen test interface.

Screen Test

Click or tap **Screen Test** to enter the screen test interface and check whether the defective pixel exists.

There are 15 screen test interfaces. Click or tap the screen to switch to the next screen test interface. Click or tap **Exit** at the upper-left corner of the interface to exit the screen test interface.

19 Preset Function

DG6000 provides one auto memory location (AUTO_RECALL) and five user-defined state memory locations (STATE_1 to STATE_5). You can store the instrument states to the specified state memory locations and recall them when necessary. Stored states include channel parameters, waveform parameters, and system parameters. Click or

tap  > **Preset** to enter the "Preset" menu, as shown in the figure below.

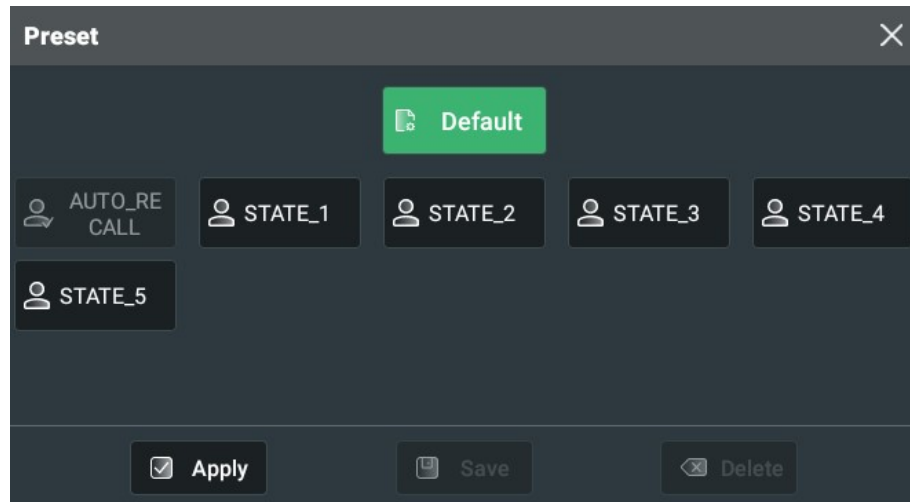

Figure 19.1 Preset Menu

TIP

If *Load Last* is set to "Last", the instrument automatically recalls the system configurations at last power-down (stored in AUTO_RECALL) when it is powered on. Also, the **AUTO_RECALL** is grayed out and cannot be modified.

Restore Default Settings

Click or tap **Default** > **Apply**. Then click or tap **OK** in the pop-up menu to reset the instrument to factory default settings. You can also press the front-panel **Default** key. For the factory default values, refer to *Table 19.1 Factory Settings*.

Store Instrument States

Click or tap one state from **STATE_1** to **STATE_5**. Then click or tap **Save** to save the current system state to the specified location in the internal non-volatile memory. If *Load Last* is set to "Default", you can also store the system state to AUTO_RECALL. If an existing state file has been stored, this operation overwrites the original file.

Recall Instrument States

When a state file has been stored in the specified location, you can select the location and then click or tap **Apply** > **OK** to recall the state file. Please note that the stored state file can only be successfully loaded when the load and save operations are

performed under the same output type. For example, a state saved under the AMP output type cannot be loaded under the HBW output type, and a prompt message "The state file does not match the output type" will be displayed.

Delete State Files

When a state file has been stored in the specified location, you can select the location and then click or tap **Delete** > **OK** to delete the state file.

Table 19.1 Factory Settings

Parameter	Factory Settings
Channel Output	
Basic Waveform	Sine
Output Mode	Continuous
Frequency	1 kHz
Period	1 ms
Amplitude Range	2.5 Vpp
Offset	0 Vdc
Phase	0°
Continuous	
Square Duty Cycle	50%
Square Fast Transition On/Off	Off
Square Transition Time	800 ps
Ramp Symmetry	50%
Pulse Display Type	Duty Cycle
Pulse Duty Cycle	50%
Pulse Width	500 μs
Pulse Leading Edge	1.4 ns
Pulse Trailing Edge	1.4 ns
Harmonic Type	Order
Harmonic Order	2
Harmonic Phase	0°
Harmonic Amplitude	2.5 Vpp
Arb Type	sinc
Burst	
State	Off
Burst Type	N-Cycle
Burst Period	10 ms
Trigger Source	Internal
Cycles	1

Parameter	Factory Settings
Phase	0°
Delay	0 s
Gated Polarity	Positive
Idle Level	1st Pt
Modulation	
AM	
Modulation Source	Internal
Shape	Sine
Modulation Frequency	100 Hz
Modulation Depth	100%
DSSC	OFF
FM	
Modulation Source	Internal
Shape	Sine
Modulation Frequency	100 Hz
Frequency Deviation	100 Hz
PM	
Modulation Source	Internal
Shape	Sine
Modulation Frequency	100 Hz
Phase Deviation	90°
ASK	
Modulation Source	Internal
Polarity	Positive
Modulation Rate	100 Hz
Modulation Amplitude	1 Vpp
FSK	
Modulation Source	Internal
Polarity	Positive
Modulation Rate	100 Hz
Hop Frequency	10 kHz
PSK	
Modulation Source	Internal
Polarity	Positive
Modulation Rate	100 Hz
Phase	180°
Pulse Width Modulation	
Modulation Source	Internal
Shape	Sine
Modulation Frequency	100 Hz
Duty Cycle Deviation	5%

Parameter	Factory Settings
Width Deviation	50 μ s
SUM	
SUM Ratio	50%
SUM Frequency	100 Hz
SUM Waveform	Sine
Sweep	
Sweep Type	Linear Sweep
Trigger Source	Internal
Start Frequency	100 Hz
Stop Frequency	1 kHz
Center Frequency	550 Hz
Frequency Span	900 Hz
Sweep Time	1 s
Return Time	0 s
Start Hold Time	0 s
Stop Hold Time	0 s
Advanced	
Advanced Waveform	Arb
Arb	
Sample Rate	1 MSa/s
Filter Mode	Normal
Sequence	
Sample Rate	1 MSa/s
Filter Mode	Normal
Timer	1 s
External Trigger Mode	Leading Edge
No. of Steps	1
Waveform	Sine
Loop	1
Wait	Off
Event Input	Off
Jump to	Next
Go To	Next
PRBS	
Bit Rate	1 Mbps
PRBS Type	PRBS3
Edge Time	2 ns
Multi-pulse	
Delay	500 ms
Trigger Source	Off

Parameter	Factory Settings
Edge Time	2 ns
Idle Level	Middle
SN	1
Pulse Count	2
H-Width	5 μ s
L-Width	5 μ s
Multi-tone	
Start Frequency	1 MHz
Spacing	1 MHz
Tone Count	2
Gain	0 dB
Phase	0°
Pattern	
Bit Rate	9.6 kbps
Preset Amplitude	User
Input Data Type	Pattern
Encoding Type	NRZ
Data Format	Binary
Data	0
IQ	
Center Frequency	100 MHz
Power	0 dBm
Data Type	ALL1
Length	10,000
Symbol Rate	1 MSa/s
Mod Type	BPSK
Code Type	OFF
Oversampling	4
Filter Type	Rectangular
Alpha/BT	0.25
Bundled Channels	
Benchmark Channel	CH1
Frequency Coupling	Off
Frequency Coupling Mode	Offset
Frequency Coupling Ratio	1
Frequency Coupling Offset	0
Phase Coupling	Off
Phase Coupling Mode	Offset
Phase Coupling Ratio	1
Phase Coupling Offset	0
Amplitude Range Coupling	Off

Parameter	Factory Settings
Amplitude Range Coupling Mode	Offset
Amplitude Range Coupling Ratio	1
Amplitude Range Coupling Offset	0
Track On/Off	Off
Channel Setup	
Sync On/Off	Off
Sync Mode	Normal
Sync Polarity	Positive
Mark Frequency	500 Hz
Trigger Output	Off
Trigger Output Polarity	Leading Edge
Invert	OFF
Impedance	HighZ
Channel Delay	0 ns
System Utility	
Trigger Level	1.65 V
Beeper	On
Clock Source	Internal
Print Screen Format	PNG

20 Remote Control

The following ways of remote control are supported:

- **User-defined Programming**

Users can program and control the instrument by using the SCPI (Standard Commands for Programmable Instruments) commands. For details about the SCPI commands and programming, refer to *Programming Guide* of this product series.

- **PC Software**

You can use the PC software to send SCPI commands to control the instrument remotely. RIGOL Ultra Sigma is recommended. You can download the software from RIGOL official website (<http://www.rigol.com>).

Operation Procedures:

- Set up communication between the instrument and PC.
- Run Ultra Sigma and search for the instrument resource.
- Open the remote command control panel to send commands.

- **Web Control**

This instrument supports Web Control. You can view the display of the real-time interface of the instrument using Web Control. Through the Web Control method, you can migrant the device control to the control terminals (e.g. PC, Mobile, iPad, and other smart terminals) to realize remote control of the instrument. Connect the instrument to the network, then input the IP address of the instrument into the address bar of the browser of your computer. When mDNS is enabled, you can also input "hostname.local" (see *LX*) to use Web Control. You have to log in before using the Web Control to modify network settings. When you first log in to the Web Control, the user name is "admin" and password is "rigol".

This instrument can be connected to the PC via the USB and LAN interface to set up communication and realize remote control through the PC.

This chapter will illustrate how to use the RIGOL Ultra Sigma software to remotely control the instrument via various interfaces.



CAUTION

Before connecting the communication cable, please turn off the instrument to avoid causing damage to the communication interfaces.

20.1 Remote Control via USB

1. Connect the device

Use the USB cable to connect the rear-panel USB DEVICE interface of the instrument to the USB HOST interface of the PC.

2. Search for the device resource

Start up Ultra Sigma and the software will automatically search for the resource currently connected to the PC via the USB interface. You can also click **USB-TMC** to search for the resource.

3. View the device resource

The resources found will appear under the "RIGOL Online Resource" directory, and the model number and USB interface information of the instrument will also be displayed.

4. Control the instrument remotely

Right-click the device resource name and select "SCPI Panel Control" to open the remotely command control panel. Then you can send commands and read data through the panel. For details about the SCPI commands and programming, refer to the Programming Guide of this instrument.

20.2 Remote Control via LAN

1. Connect the device

Use the network cable to connect the instrument to your local area network (LAN).

2. Configure network parameters

Configure the network parameters of the instrument in **Utility>IO** menu.

3. Search for Search device resource

Start up Ultra Sigma and click **LAN** to open the panel as shown in the figure below. Click **Search** and the software searches for the instrument resources currently connected to the LAN and the resources found are displayed at the right section of the window as shown in the figure below. Click **OK** to add it.

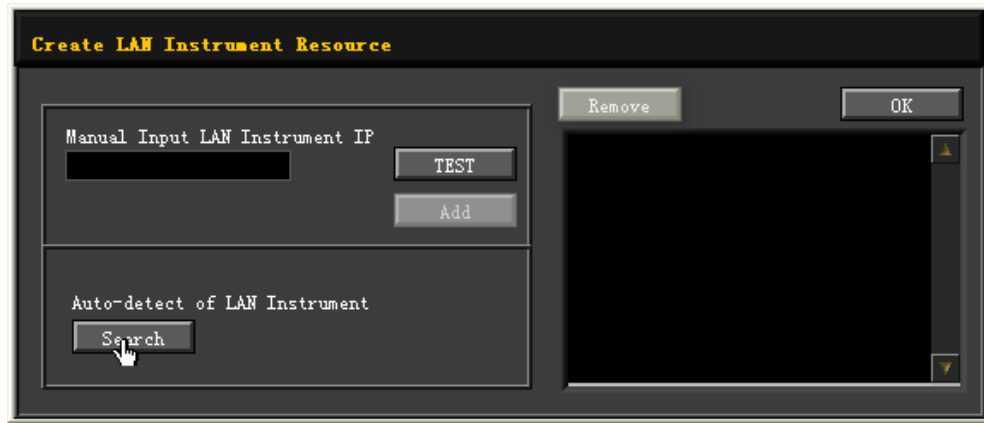

Besides, you can input the IP address of the instrument manually into the text field under "Manual Input LAN Instrument IP", then click **TEST**. If the instrument passes the test, click **Add** to add the instrument to the LAN instrument resource list in the right section; if the instrument fails the test, please check whether the IP address that you input is correct, or use the auto search method to add the instrument resource.

4. View the device resource

The resources found will appear under the "RIGOL Online Resource" directory.

5. Control the instrument remotely

Right-click the device resource name and select "SCPI Panel Control" to open the remotely command control panel. Then you can send commands and read data through the panel.

6. Load LXI webpage

As this instrument conforms to LXI CORE 2011 DEVICE standards, you can load LXI web page through Ultra Sigma (right-click the instrument resource name and select "LXI-Web"). Various important information about the instrument (including the model, manufacturer, serial number, description, MAC address, and IP address) will be displayed on the web page. You can also directly input the IP address of the instrument in the address bar of the PC browser to load the LXI web page.

21 Troubleshooting

1. When I power on the instrument, the instrument stays black and does not display anything.

- a. Check whether the power supply has been connected correctly.
- b. Check whether the power key is really pressed.
- c. Check whether the fuse is blown. If you need to replace the fuse, use only the specified fuse that conforms to the product.
- d. Restart the instrument after finishing the above inspections.
- e. If the problem still persists, please contact RIGOL.

2. The settings are correct but no waveform is generated.

- a. Check whether the output cable is connected to the corresponding channel output terminal tightly.
- b. Check whether the output cable works properly.
- c. Check whether the output cable is connected to the test instrument tightly.
- d. If the problem still persists, please contact RIGOL.

3. The USB storage device cannot be recognized.

- a. Check whether the USB storage device can work normally when connected to other instruments or PC.
- b. Make sure that the USB storage device is FAT32, NTFS, or exFAT type. The instrument doesn't support hardware USB storage device.
- c. After restarting the instrument, insert the USB storage device again to check whether it can work normally.
- d. If the USB storage device still cannot work normally, please contact RIGOL.

4. Performance verification test is failed.

- a. Check whether the generator is within calibration period (1 year).
- b. Check whether the generator has been warmed up for at least 30 minutes before the test.
- c. Check whether the generator is under the specified temperature.
- d. Check whether the test is under strong-magnetism environment.
- e. Check whether the power supplies of the generator and test system have a strong interference.

- f. Check whether the performance of the test device used meets the requirement.
 - g. Make sure that the test device used is within the calibration period.
 - h. Check whether the test device used meets the required conditions of the manual.
 - i. Check whether all the connections are tight.
 - j. Check whether any cable has internal damage.
 - k. Make sure that the operations conform to settings and processes which are required by the performance verification manual.
 - l. Check whether the error calculation has faults.
 - m. Correctly understand the definition of "typical value" for this product: the performance specification of this product under specified conditions.
- 5. The touch-enabled operation does not work.**
- a. Check whether you have locked the touch screen. If yes, unlock the touch screen.
 - b. Check whether the screen or your finger is stained with oil or sweat. If yes, please clean the screen or dry your hands.
 - c. Check whether there is a strong magnetic field around the instrument. If the instrument is close to the strong magnetic field (e.g. a magnet), please move the instrument away from the magnet field.
 - d. If the problem still persists, please contact RIGOL.

22 Appendix

22.1 Appendix A: Options and Accessories

Order Information	Order No.
Model	
500 MHz Bandwidth, 2.5 GSa/s Sample Rate, Dual-channel	DG6052
500 MHz Bandwidth, 2.5 GSa/s Sample Rate, Four-channel	DG6054
1 GHz Bandwidth, 2.5 GSa/s Sample Rate, Dual-channel	DG6102
1 GHz Bandwidth, 2.5 GSa/s Sample Rate, Four-channel	DG6104
Standard Accessories	
Power Cord Conforming to the Standard of the Destination Country	— —
SMB Pin Insertion/extraction Tool	— —
USB Cable	CB-USBA-USBB-FF-150
4/8 BNC Cables	CB-BNC-BNC-MM-100
Option	
512 Mpts/CH Max. Arb Length Upgrade Option	DG6000-2RL
Optional Accessories	
40dB Attenuator (50 Ω , 1 W)	RA5040K
SMB(F) to SMB(F) Cable (1 m)	CB-SMB-SMB-FF-100
SMB(F) to BNC(F) Cable (1 m)	CB-SMB-BNC-FF-100
SMB(F) to BNC(M) Cable (1 m)	CB-SMB-BNC-FM-100
BNC to Alligator Clip Cable	CB-BNC-AC-100-L

22.2 Appendix B: Warranty

RIGOL TECHNOLOGIES CO., LTD. (hereinafter referred to as RIGOL) warrants that the product mainframe and product accessories will be free from defects in materials and workmanship within the warranty period. If a product proves defective within the warranty period, RIGOL guarantees free replacement or repair for the defective product.

To get repair service, please contact your nearest RIGOL sales or service office.

There is no other warranty, expressed or implied, except such as is expressly set forth herein or other applicable warranty card. There is no implied warranty of merchantability or fitness for a particular purpose. Under no circumstances shall RIGOL be liable for any consequential, indirect, ensuing, or special damages for any breach of warranty in any case.

Boost Smart World and Technology Innovation

Industrial Intelligent
Manufacturing



Semiconductors

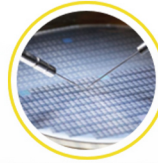

Education &
Research

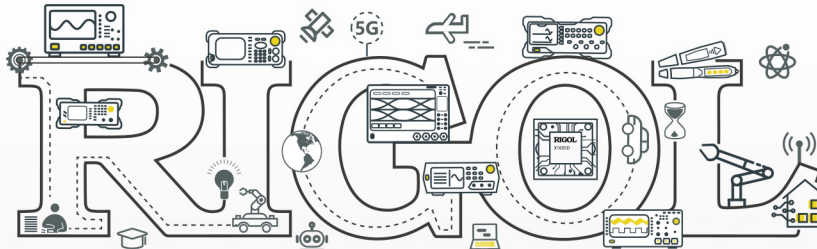

Communication

System Integration

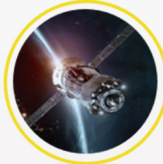

New Energy



- 5G Cellular-5G/WIFI
- UWB/RFID/ ZIGBEE
- Digital Bus/Ethernet
- Optical Communication

- Digital/Analog/RF Chip
- Memory and MCU Chip
- Third-Generation Semiconductor
- Solar Photovoltaic Cells

- New Energy Automobile
- PV/Inverter
- Power Test
- Automotive Electronics

*Provide Testing and Measuring Products
and Solutions for Industry Customers*

HEADQUARTER

RIGOL TECHNOLOGIES CO., LTD.
No.8 Keling Road, New District,
Suzhou, JiangSu, P.R.China
Tel: +86-400620002
Email: info-cn@rigol.com

JAPAN

RIGOL JAPAN CO., LTD.
5F, 3-45-6, Minamiotsuka, Toshima-Ku,
Tokyo, 170-0005, Japan
Tel: +81-3-6262-8932
Fax: +81-3-6262-8933
Email: info.jp@rigol.com

EUROPE

RIGOL TECHNOLOGIES EU GmbH
Friedrichshafener Str. 5
82205 Gilching
Germany
Tel: +49(0)8105-27292-21
Email: info-europe@rigol.com

KOREA

RIGOL KOREA CO., LTD.
5F, 222, Gonghang-daero,
Gangseo-gu, Seoul, Republic of Korea
Tel: +82-2-6953-4466
Fax: +82-2-6953-4422
Email: info.kr@rigol.com

NORTH AMERICA

RIGOL TECHNOLOGIES, USA INC.
10220 SW Nimbus Ave.
Suite K-7
Portland, OR 97223
Tel: +1-877-4-RIGOL-1
Email: sales@rigol.com

For Assistance in Other Countries

Email: info.int@rigol.com