

# DNA6000-R Series

---

## Vector Network Analyzer

### Programming Guide

Apr.2026



## **Guaranty and Declaration**

### **Copyright**

© 2026 RIGOL TECHNOLOGIES CO., LTD. All Rights Reserved.

### **Trademark Information**

RIGOL® is the trademark of RIGOL TECHNOLOGIES CO., LTD.

### **Notices**

- RIGOL products are covered by P.R.C. and foreign patents, issued and pending.
- RIGOL reserves the right to modify or change parts of or all the specifications and pricing policies at the company's sole decision.
- Information in this publication replaces all previously released materials.
- Information in this publication is subject to change without notice.
- RIGOL shall not be liable for either incidental or consequential losses in connection with the furnishing, use, or performance of this manual, as well as any information contained.
- Any part of this document is forbidden to be copied, photocopied, or rearranged without prior written approval of RIGOL.

### **Product Certification**

RIGOL guarantees that this product conforms to the national and industrial standards in China as well as the ISO9001:2015 standard and the ISO14001:2015 standard. Other international standard conformance certifications are in progress.

### **Contact Us**

If you have any problem or requirement when using our products or this manual, please contact RIGOL.

E-mail: [service@rigol.com](mailto:service@rigol.com)

Website: <http://www.rigol.com>

Section	Description	Page
1	Document Overview .....	1
2	Programming Overview .....	3
2.1	SCPI Command Overview .....	3
2.2	Remote Control .....	5
3	IEEE488.2 Common Commands .....	8
3.1	*IDN? .....	9
3.2	*RST .....	10
3.3	*CLS .....	10
3.4	*ESE .....	11
3.5	*ESR? .....	12
3.6	*OPC .....	12
3.7	*RCL .....	13
3.8	*SAV .....	13
3.9	*SRE .....	14
3.10	*STB? .....	14
3.11	*WAI .....	15
3.12	*TST? .....	15
3.13	:GPIB:PARSe:END .....	16
4	:SOURce<cn> Commands .....	17
4.1	:SOURce<cn>:POWer<pn>[:LEVel][:IMMediate][:AMPLitude] .....	17
4.2	:SOURce<cn>:POWer[:LEVel][:AMPLitude] .....	18
4.3	:SOURce<cn>:POWer<pn>:STARt .....	18
4.4	:SOURce<cn>:POWer<pn>:STOP .....	19
5	:Display Commands .....	21
5.1	:DISPlay:TRACe:NEW .....	21
5.2	:Display:MEASure Commands .....	21
5.2.1	:DISPlay:MEASure<mn>:DELeTe .....	21
5.2.2	:DISPlay:MEASure<mn>[:STATe] .....	22
5.2.3	:DISPlay:MEASure<mn>:SELeCt .....	23
5.2.4	:DISPlay:MEASure<mn>:TITLe:DATA .....	23
5.2.5	:DISPlay:MEASure<mn>:TITLe[:STATe] .....	24
5.2.6	:DISPlay:MEASure<mn>:Y[:SCALe]:PDIVision .....	24
5.2.7	:DISPlay:MEASure<mn>:Y[:SCALe]:RLeVel .....	25

5.2.8	:DISPlay:MEASure<mn>:Y[:SCALe]:RPOsition	26
5.3	:DisPlay:CHANnel Commands	26
5.3.1	:DISPlay:CHANnel:NEW	26
5.3.2	:DISPlay:CHANnel<cn>:STATe	27
5.4	:DisPlay:WINDow Commands	28
5.4.1	:DISPlay:WINDow:NEW	28
5.4.2	:DISPlay:WINDow:TRACe:GRATicule:GRID:LTYPE	29
5.4.3	:DISPlay:WINDow<wn>:TRACe<tn>:Y[:SCALe]:AUTO	29
5.4.4	:DISPlay:WINDow<wn>:TRACe<tn>:Y[:SCALe]:PDIVision	30
5.4.5	:DISPlay:WINDow<wn>:TRACe<tn>:Y[:SCALe]:RLEVel	30
5.4.6	:DISPlay:WINDow<wn>:TRACe<tn>:Y[:SCALe]:RPOsition	31
5.4.7	:DISPlay:WINDow<wn>:TRACe<tn>[:STATe]	32
5.4.8	:DISPlay:WINDow<wn>:TRACe<tn>:MEMory[:STATe]	33
5.4.9	:DISPlay:WINDow<wn>[:STATe]	33
5.4.10	:DISPlay:WINDow<wn>:Y:AUTO	34
5.4.11	:DISPlay:WINDow<wn>:Y[:SCALe]:DIVisions?	34
5.4.12	:DISPlay:WINDow<wn>:TITLe:DATA	35
5.4.13	:DISPlay:WINDow<wn>:TITLe[:STATe]	36
5.4.14	:DISPlay:WINDow<wn>:TABLe	36
5.4.15	:DISPlay:WINDow<wn>:CATalog?	37
5.5	:DisPlay:SHEEt Commands	37
5.5.1	:DISPlay:SHEEt:NEW	38
5.5.2	:DISPlay:SHEEt<shnum>:STATe	38
5.5.3	:DISPlay:SHEEt<shnum>:TITLe:DATA	39
5.6	:DISPlay:FSIGn	40
5.7	:DISPlay:LIMit:GLOBal:FAIL?	40
5.8	:DISPlay:LIMit:GLOBal:FAIL:TRACes?	41
6	:SENSe<cn> Commands	42
6.1	:SENSe<cn>:FREQuency Commands	42
6.1.1	:SENSe<cn>:FREQuency:STARt	42
6.1.2	:SENSe<cn>:FREQuency:STOP	43
6.1.3	:SENSe<cn>:FREQuency:CENTer	43
6.1.4	:SENSe<cn>:FREQuency:SPAN	44
6.1.5	:SENSe<cn>:FREQuency:CW	45
6.1.6	:SENSe<cn>:FREQuency:FIXed	45
6.1.7	:SENSe<cn>:FREQuency:DATA?	46
6.2	:SENSe<cn>:SWEep Commands	47

6.2.1	:SENSe<cn>:SWEep:STEP	47
6.2.2	:SENSe<cn>:SWEep:POINts	47
6.2.3	:SENSe<cn>:SWEep:TYPE	48
6.2.4	:SENSe<cn>:SWEep:TIME:AUTO	49
6.2.5	:SENSe<cn>:SWEep:TIME[:STOP]	49
6.2.6	:SENSe<cn>:SWEep:GENeration:POINtsweep	50
6.2.7	:SENSe<cn>:SWEep:DWELl	51
6.2.8	:SENSe<cn>:SWEep:DWELl:SDELay	52
6.2.9	:SENSe<cn>:SWEep:GROups:COUNT	52
6.2.10	:SENSe<cn>:SWEep:MODE	53
6.2.11	:SENSe<cn>:SWEep:TRIGger:MODE	54
6.3	:SENSe<cn>:BANDwidth Commands	55
6.3.1	:SENSe<cn>:BANDwidth[:RESolution]	55
6.3.2	:SENSe<cn>:BWIDth[:RESolution]	55
6.4	:SENSe<cn>:SEGMENT Commands	56
6.4.1	:SENSe<cn>:SEGMENT:DELete:ALL	56
6.4.2	:SENSe<cn>:SEGMENT:SWEep:DWELl:CONTRol	57
6.4.3	:SENSe<cn>:SEGMENT:SWEep:TIME:CONTRol	57
6.4.4	:SENSe<cn>:SEGMENT:SWEep:DeLay:CONTRol	58
6.4.5	:SENSe<cn>:SEGMENT:BWIDth[:RESolution]:CONTRol	59
6.4.6	:SENSe<cn>:SEGMENT:BWIDth:PORT[:RESolution]:CONTRol	59
6.4.7	:SENSe<cn>:SEGMENT:POWEr[:LEVEl]:CONTRol	60
6.4.8	:SENSe<cn>:SEGMENT<sgn>:ADD	61
6.4.9	:SENSe<cn>:SEGMENT<sgn>:DELete	61
6.4.10	:SENSe<cn>:SEGMENT<sgn>[:STATe]	62
6.4.11	:SENSe<cn>:SEGMENT<sgn>:FREQUency:STARt	63
6.4.12	:SENSe<cn>:SEGMENT<sgn>:FREQUency:STOP	63
6.4.13	:SENSe<cn>:SEGMENT<sgn>:SWEep:POINts	64
6.4.14	:SENSe<cn>:SEGMENT<sgn>:SWEep:TIME	65
6.4.15	:SENSe<cn>:SEGMENT<sgn>:SWEep:DWELl	66
6.4.16	:SENSe<cn>:SEGMENT<sgn>:SWEep:DELay	67
6.4.17	:SENSe<cn>:SEGMENT<sgn>:BWIDth[:RESolution]	67
6.4.18	:SENSe<cn>:SEGMENT<sgn>:BWIDth:PORT<pn>[:RESolution]	68
6.4.19	:SENSe<cn>:SEGMENT<sgn>:POWEr[<pn>][:LEVEl]	69
6.5	:SENSe<cn>:CORRection Commands	70
6.5.1	:SENSe<cn>:CORRection[:STATe]	70
6.5.2	:SENSe<cn>:CORRection:RVELOCITY:COAX	71

6.5.3	:SENSe<cn>:CORRection:INTerpolate[:STATe]	72
6.5.4	:SENSe<cn>:CORRection:EXTeNsion:STATe	72
6.5.5	:SENSe<cn>:CORRection:EXTeNsion:RESet	73
6.5.6	:SENSe<cn>:CORRection:EXTeNsion:PORT:UNIT	73
6.5.7	:SENSe<cn>:CORRection:EXTeNsion:PORT<pn>[:TIME]	74
6.5.8	:SENSe<cn>:CORRection:EXTeNsion:PORT<pn>:DIsTance	75
6.5.9	:SENSe<cn>:CORRection:EXTeNsion:PORT<pn>:LDC	76
6.5.10	:SENSe<cn>:CORRection:EXTeNsion:PORT<pn>:SYsVelocity	77
6.5.11	:SENSe<cn>:CORRection:EXTeNsion:PORT<pn>:VELFactor	78
6.5.12	:SENSe<cn>:CORRection:EXTeNsion:PORT<pn>:INCLude<lossid>[:STATe]	79
6.5.13	:SENSe<cn>:CORRection:EXTeNsion:PORT<pn>:FREQUency<lossid>	80
6.5.14	:SENSe<cn>:CORRection:EXTeNsion:PORT<pn>:LOSS<lossid>	81
6.5.15	:SENSe<cn>:CORRection:EXTeNsion:AUTO:PORT	82
6.5.16	:SENSe<cn>:CORRection:EXTeNsion:AUTO:CONFig	83
6.5.17	:SENSe<cn>:CORRection:EXTeNsion:AUTO:START	84
6.5.18	:SENSe<cn>:CORRection:EXTeNsion:AUTO:STOP	85
6.5.19	:SENSe<cn>:CORRection:EXTeNsion:AUTO:LOSS	85
6.5.20	:SENSe<cn>:CORRection:EXTeNsion:AUTO:DCOFFset	86
6.5.21	:SENSe<cn>:CORRection:EXTeNsion:AUTO:MEASure	87
6.5.22	:SENSe<cn>:CORRection:EXTeNsion:AUTO:RESet	87
6.5.23	:SENSe<cn>:CORRection:COLLect:SAVE	88
6.5.24	:SENSe<cn>:CORRection:COLLect:METhod	88
6.5.25	:SENSe<cn>:CORRection:COLLect[:ACQUire]	89
6.5.26	:SENSe<cn>:CORRection:SFORward[:STATe]	90
6.5.27	:SENSe<cn>:CORRection:TSTandards[:STATe]	90
6.5.28	:SENSe<cn>:CORRection:DATA:CDATA?	91
6.5.29	:SENSe:CORRection:COLLect:GUIDed:CONNector:CATalog?	91
6.5.30	:SENSe:CORRection:COLLect:GUIDed:CKIT:CATalog?	92
6.5.31	:SENSe:CORRection:CKIT:INITialize[:IMMediate]	92
6.5.32	:SENSe:CORRection:CKIT:CLear[:IMMediate]	93
6.5.33	:SENSe:CORRection:CKIT:COUnT?	93
6.5.34	:SENSe:CORRection:CKIT:IMPort	94
6.5.35	:SENSe:CORRection:CKIT:EXPort	94
6.5.36	:SENSe:CORRection:CKIT:LOAD	95
6.5.37	:SENSe:CORRection:IMPedance:INPut:MAGNitude	96
6.6	:SENSe<cn>:AVERAge Commands	96
6.6.1	:SENSe<cn>:AVERAge:MODE	96

6.6.2	:SENSe<cn>:AVERAge[:STATe]	97
6.6.3	:SENSe<cn>:AVERAge:COUNT	98
6.6.4	:SENSe<cn>:AVERAge:CLEar	98
6.7	:SENSe<cn>:COUPlE:PARAmeter[:STATe]	99
7	:CALCulate<cn> Commands	101
7.1	:CALCulate<cn>:PARAmeter:CATalog:EXTended?	101
7.2	:CALCulate<cn>:PARAmeter[:DEFine]:EXTended	101
7.3	:CALCulate<cn>:PARAmeter:COUNT	102
7.4	:CALCulate<cn>:PARAmeter:SElect	103
7.5	:CALCulate<cn>:PARAmeter:DELeTe[:NAME]	104
7.6	:CALCulate<cn>:PARAmeter:DELeTe:ALL	104
7.7	:CALCulate<cn>:PARAmeter:MNUMber[:SElect]	105
7.8	:CALCulate<cn>:PARAmeter<mn>:DEFine	105
7.9	:CALCulate<cn>:MEASure<mn>:PARAmeter	106
7.10	:CALCulate<cn>:MEASure<mn>:CONVersion:FUNCTion	107
7.11	:CALCulate<cn>:MEASure<mn>:FORMat	108
7.12	:CALCulate<cn>:FORMat	109
7.13	:CALCulate<cn>:DATA:SNP:PORTs?	110
7.14	:CALCulate<cn>:LIMit:STATe	111
7.15	:CALCulate<cn>:MARKer:AOff	112
7.16	:CALCulate<cn>:MARKer<mk>[:STATe]	112
7.17	:CALCulate<cn>:MARKer<mk>:X	113
7.18	:CALCulate<cn>:MARKer<mk>:Y?	114
7.19	:CALCulate<cn>:MEASure<mn>:DATA Commands	115
7.19.1	:CALCulate<cn>:MEASure<mn>:DATA:FDATA?	115
7.19.2	:CALCulate<cn>:MEASure<mn>:DATA:SDATA?	116
7.19.3	:CALCulate<cn>:MEASure<mn>:DATA:X[:VALues]?	117
7.20	:CALCulate<cn>:MEASure<mn>:HOLD Commands	117
7.20.1	:CALCulate<cn>:MEASure<mn>:HOLD:TYPE	117
7.20.2	:CALCulate<cn>:MEASure<mn>:HOLD:CLEar	118
7.21	:CALCulate<cn>:MEASure<mn>:MATH Commands	119
7.21.1	:CALCulate<cn>:MEASure<mn>:MATH:MEMorize	119
7.21.2	:CALCulate<cn>:MEASure<mn>:MATH:NORMalize	119
7.21.3	:CALCulate<cn>:MEASure<mn>:MATH:MEMory:STATe?	120
7.21.4	:CALCulate<cn>:MEASure<mn>:MATH:FUNCTion	120
7.22	:CALCulate<cn>:MEASure<mn>:GDELay Commands	121
7.22.1	:CALCulate<cn>:MEASure<mn>:GDELay:PERCent	122

7.22.2	:CALCulate<cn>:MEASure<mn>:GDElay:POINts	122
7.22.3	:CALCulate<cn>:MEASure<mn>:GDElay:FREQuency	123
7.23	:CALCulate<cn>:MEASure<mn>:FUNction Commands	124
7.23.1	:CALCulate<cn>:MEASure<mn>:FUNction:STATistics[:STATe]	124
7.23.2	:CALCulate<cn>:MEASure<mn>:FUNction:TYPE	125
7.23.3	:CALCulate<cn>:MEASure<mn>:FUNction:DATA?	126
7.23.4	:CALCulate<cn>:MEASure<mn>:FUNction:DOMain:USER[:RANGe]	127
7.23.5	:CALCulate<cn>:MEASure<mn>:FUNction:DOMain:USER:START	128
7.23.6	:CALCulate<cn>:MEASure<mn>:FUNction:DOMain:USER:STOP	129
7.24	:CALCulate<cn>:MEASure<mn>:MARKer Commands	130
7.24.1	:CALCulate<cn>:MEASure<mn>:MARKer:AOFF	130
7.24.2	:CALCulate<cn>:MEASure<mn>:MARKer<mk>[:STATe]	130
7.24.3	:CALCulate<cn>:MEASure<mn>:MARKer<mk>:COUPLing[:STATe]	131
7.24.4	:CALCulate<cn>:MEASure<mn>:MARKer<mk>:COUPLing:METHod	132
7.24.5	:CALCulate<cn>:MEASure<mn>:MARKer<mk>:DELTA	133
7.24.6	:CALCulate<cn>:MEASure<mn>:MARKer<mk>:DIScrete	134
7.24.7	:CALCulate<cn>:MEASure<mn>:MARKer<mk>:FORMat	134
7.24.8	:CALCulate<cn>:MEASure<mn>:MARKer<mk>:TYPE	136
7.24.9	:CALCulate<cn>:MEASure<mn>:MARKer<mk>:X	137
7.24.10	:CALCulate<cn>:MEASure<mn>:MARKer<mk>:Y?	137
7.24.11	:CALCulate<cn>:MEASure<mn>:MARKer<mk>:FUNction:EXECute	138
7.24.12	:CALCulate<cn>:MEASure<mn>:MARKer<mk>:FUNction[:SElect]	139
7.24.13	:CALCulate<cn>:MEASure<mn>:MARKer<mk>:FUNction:TRACKing	141
7.24.14	:CALCulate<cn>:MEASure<mn>:MARKer<mk>:FUNction:DOMain:USER[:RANGe]	141
7.24.15	:CALCulate<cn>:MEASure<mn>:MARKer<mk>:FUNction:DOMain:USER:START	143
7.24.16	:CALCulate<cn>:MEASure<mn>:MARKer<mk>:FUNction:DOMain:USER:STOP	144
7.24.17	:CALCulate<cn>:MEASure<mn>:MARKer<mk>:FUNction:PEAK:EXCurSION	145
7.24.18	:CALCulate<cn>:MEASure<mn>:MARKer<mk>:FUNction:PEAK:POLarity	146
7.24.19	:CALCulate<cn>:MEASure<mn>:MARKer<mk>:FUNction:PEAK:THReshold	147
7.24.20	:CALCulate<cn>:MEASure<mn>:MARKer<mk>:FUNction:TARGet[:VALue]	148
7.24.21	:CALCulate<cn>:MEASure<mn>:MARKer<mk>:FUNction:TARGet:TRANSition	149
7.24.22	:CALCulate<cn>:MEASure<mn>:MARKer<mk>:FUNction:MULTi:PEAK:EXCurSION	149
7.24.23	:CALCulate<cn>:MEASure<mn>:MARKer<mk>:FUNction:MULTi:PEAK:POLarity	151
7.24.24	:CALCulate<cn>:MEASure<mn>:MARKer<mk>:FUNction:MULTi:PEAK:THReshold	152
7.24.25	:CALCulate<cn>:MEASure<mn>:MARKer<mk>:FUNction:MULTi:TARGet[:VALue]	153
7.24.26	:CALCulate<cn>:MEASure<mn>:MARKer<mk>:FUNction:MULTi:TARGet:TRANSition	154
7.24.27	:CALCulate<cn>:MEASure<mn>:MARKer<mk>:FUNction:MULTi:EXECute	155

7.24.28	:CALCulate<cn>:MEASure<mn>:MARKer<mk>:FUNction:MULTi:SElect	.....155
7.24.29	:CALCulate<cn>:MEASure<mn>:MARKer<mk>:FUNction:MULTi:TRACking	156
7.24.30	:CALCulate<cn>:MEASure<mn>:MARKer<mk>:SET	.....157
7.25	:CALCulate<cn>:MEASure<mn>:LIMit Commands	.....158
7.25.1	:CALCulate<cn>:MEASure<mn>:LIMit[:STATe]	.....159
7.25.2	:CALCulate<cn>:MEASure<mn>:LIMit:SOUNd[:STATe]	.....159
7.25.3	:CALCulate<cn>:MEASure<mn>:LIMit:DISPlay[:STATe]	.....160
7.25.4	:CALCulate<cn>:MEASure<mn>:LIMit:SEGMENT<sgn>:TYPE	.....161
7.25.5	:CALCulate<cn>:MEASure<mn>:LIMit:SEGMENT<sgn>:STIMulus:STARt	.....162
7.25.6	:CALCulate<cn>:MEASure<mn>:LIMit:SEGMENT<sgn>:STIMulus:STOP	.....163
7.25.7	:CALCulate<cn>:MEASure<mn>:LIMit:SEGMENT<sgn>:AMPLitude:STARt	...164
7.25.8	:CALCulate<cn>:MEASure<mn>:LIMit:SEGMENT<sgn>:AMPLitude:STOP	....165
7.25.9	:CALCulate<cn>:MEASure<mn>:LIMit:FAIL?	.....165
7.26	:CALCulate<cn>:MEASure<mn>:DELay Commands	.....166
7.26.1	:CALCulate<cn>:MEASure<mn>:DELay:STATe	.....166
7.26.2	:CALCulate<cn>:MEASure<mn>:DELay:POSition	.....167
7.26.3	:CALCulate<cn>:MEASure<mn>:DELay:DATA?	.....168
7.27	:CALCulate<cn>:MEASure<mn>:DTIME Commands	.....168
7.27.1	:CALCulate<cn>:MEASure<mn>:DTIME:STATe	.....168
7.27.2	:CALCulate<cn>:MEASure<mn>:DTIME:POSition	.....169
7.27.3	:CALCulate<cn>:MEASure<mn>:DTIME:TARGet	.....170
7.27.4	:CALCulate<cn>:MEASure<mn>:DTIME:DATA?	.....171
7.27.5	:CALCulate<cn>:MEASure<mn>:DTIME:LIMit:STATe	.....171
7.27.6	:CALCulate<cn>:MEASure<mn>:DTIME:LIMit:LIMit	.....172
7.27.7	:CALCulate<cn>:MEASure<mn>:DTIME:LIMit:FAIL?	.....173
7.28	:CALCulate<cn>:MEASure<mn>:SMOothing Commands	.....173
7.28.1	:CALCulate<cn>:MEASure<mn>:SMOothing[:STATe]	.....173
7.28.2	:CALCulate<cn>:MEASure<mn>:SMOothing:APERture	.....174
7.28.3	:CALCulate<cn>:MEASure<mn>:SMOothing:POINts	.....175
7.29	:CALCulate<cn>:MEASure<mn>:CORRection:EDELay Commands	.....176
7.29.1	:CALCulate<cn>:MEASure<mn>:CORRection:EDELay:UNIT	.....176
7.29.2	:CALCulate<cn>:MEASure<mn>:CORRection:EDELay:DISTance	.....177
7.29.3	:CALCulate<cn>:MEASure<mn>:CORRection:EDELay[:TIME]	.....178
7.30	:CALCulate<cn>:MEASure<mn>:OFFSet Commands	.....178
7.30.1	:CALCulate<cn>:MEASure<mn>:OFFSet:MAGNitude	.....178
7.30.2	:CALCulate<cn>:MEASure<mn>:OFFSet:MAGNitude:SLOPe	.....179
7.30.3	:CALCulate<cn>:MEASure<mn>:OFFSet:PHASe	.....180

7.31	:CALCulate<cn>:MEASure<mn>:TRANSform Commands	181
7.31.1	:CALCulate<cn>:MEASure<mn>:TRANSform:TIME:STATe	181
7.31.2	:CALCulate<cn>:MEASure<mn>:TRANSform:TIME:START	182
7.31.3	:CALCulate<cn>:MEASure<mn>:TRANSform:TIME:STOP	182
7.31.4	:CALCulate<cn>:MEASure<mn>:TRANSform:TIME:CENTer	183
7.31.5	:CALCulate<cn>:MEASure<mn>:TRANSform:TIME:SPAN	184
7.31.6	:CALCulate<cn>:MEASure<mn>:TRANSform:TIME[:TYPE]	185
7.31.7	:CALCulate<cn>:MEASure<mn>:TRANSform:TIME:LPFRequency	186
7.31.8	:CALCulate<cn>:MEASure<mn>:TRANSform:TIME:MARKer:MODE	186
7.31.9	:CALCulate<cn>:MEASure<mn>:TRANSform:TIME:MARKer:UNIT	187
7.31.10	:CALCulate<cn>:MEASure<mn>:TRANSform:TIME:KBESsel	188
7.31.11	:CALCulate<cn>:MEASure<mn>:TRANSform:TIME:IMPulse:WIDTh	189
7.31.12	:CALCulate<cn>:MEASure<mn>:TRANSform:TIME:WINDow[:TYPE]	190
7.31.13	:CALCulate<cn>:MEASure<mn>:TRANSform:DTFault:STATe	191
7.31.14	:CALCulate<cn>:MEASure<mn>:TRANSform:DTFault:LENGth:UNIT	191
7.31.15	:CALCulate<cn>:MEASure<mn>:TRANSform:DTFault:STOP	192
7.31.16	:CALCulate<cn>:MEASure<mn>:TRANSform:DTFault:LOSS:COAX	193
7.31.17	:CALCulate<cn>:MEASure<mn>:TRANSform:DTFault:VELocity	194
7.31.18	:CALCulate<cn>:MEASure<mn>:TRANSform:COUPle:PARAmeters	194
7.32	:CALCulate<cn>:MEASure<mn>:FILTer Commands	196
7.32.1	:CALCulate<cn>:MEASure<mn>:FILTer:GATE:TIME:STATe	196
7.32.2	:CALCulate<cn>:MEASure<mn>:FILTer:GATE:TIME:START	196
7.32.3	:CALCulate<cn>:MEASure<mn>:FILTer:GATE:TIME:STOP	197
7.32.4	:CALCulate<cn>:MEASure<mn>:FILTer:GATE:TIME:CENTer	198
7.32.5	:CALCulate<cn>:MEASure<mn>:FILTer:GATE:TIME:SPAN	199
7.32.6	:CALCulate<cn>:MEASure<mn>:FILTer:GATE:TIME:SHAPE	199
7.32.7	:CALCulate<cn>:MEASure<mn>:FILTer:GATE:COUPle:PARAmeters	200
7.33	:CALCulate<cn>:FSIMulator Commands	201
7.33.1	:CALCulate<cn>:FSIMulator:STATe	201
7.33.2	:CALCulate<cn>:FSIMulator:SNP:EXTRapolate	202
7.33.3	:CALCulate<cn>:FSIMulator:SENDEd:PMCircuit:STATe	203
7.33.4	:CALCulate<cn>:FSIMulator:SENDEd:PMCircuit:PORT<pn>[:TYPE]	203
7.33.5	:CALCulate<cn>:FSIMulator:SENDEd:PMCircuit:PORT<pn>:USER:FILEname	204
7.33.6	:CALCulate<cn>:FSIMulator:SENDEd:PMCircuit:PORT<pn>:PARAmeters:C	206
7.33.7	:CALCulate<cn>:FSIMulator:SENDEd:PMCircuit:PORT<pn>:PARAmeters:G	207
7.33.8	:CALCulate<cn>:FSIMulator:SENDEd:PMCircuit:PORT<pn>:PARAmeters:L	208
7.33.9	:CALCulate<cn>:FSIMulator:SENDEd:PMCircuit:PORT<pn>:PARAmeters:R	209

7.33.10	:CALCulate<cn>:FSIMulator:SENDEd:PMCircuit:PORT<pn>:SNP:RANGe?	...210
7.33.11	:CALCulate<cn>:FSIMulator:SENDEd:DEEMbed:STATE	.....211
7.33.12	:CALCulate<cn>:FSIMulator:SENDEd:DEEMbed:PORT<pn>[:TYPE]	.....212
7.33.13	:CALCulate<cn>:FSIMulator:SENDEd:DEEMbed:PORT<pn>:USER:FILename	213
7.33.14	:CALCulate<cn>:FSIMulator:SENDEd:DEEMbed:PORT<pn>:SNP:REVerse	....214
7.33.15	:CALCulate<cn>:FSIMulator:SENDEd:DEEMbed:PORT<pn>:SNP:RANGe?	...215
7.33.16	:CALCulate<cn>:FSIMulator:SENDEd:ZCONversion:STATE	.....216
7.33.17	:CALCulate<cn>:FSIMulator:SENDEd:ZCONversion:PORT<pn>:REAL	.....216
7.33.18	:CALCulate<cn>:FSIMulator:SENDEd:ZCONversion:PORT<pn>:IMAG	.....217
7.33.19	:CALCulate<cn>:FSIMulator:SENDEd:ZCONversion:PORT<pn>:Z0[R]	.....218
7.33.20	:CALCulate<cn>:FSIMulator:DRAft:EXTension:PORT<pn>:VELOCITY:FACTOR	.219
7.33.21	:CALCulate<cn>:FSIMulator:BALun:DEVIce	.....220
7.33.22	:CALCulate<cn>:FSIMulator:BALun:TOPology:BALanced[:PPORTs]	.....221
7.33.23	:CALCulate<cn>:FSIMulator:BALun:TOPology:BBALanced[:PPORTs]	.....222
7.33.24	:CALCulate<cn>:FSIMulator:BALun:TOPology:BSSended[:PPORTs]	.....223
7.33.25	:CALCulate<cn>:FSIMulator:BALun:TOPology:SBALanced[:PPORTs]	.....224
7.33.26	:CALCulate<cn>:FSIMulator:BALun:TOPology:SSBalanced[:PPORTs]	.....225
7.33.27	:CALCulate<cn>:FSIMulator:BALun:TOPology:BSSended[:PPORTs]	.....226
8	:INITiate Commands	.....228
8.1	:INITiate:CONTinuous	.....228
9	:LAN Commands	.....229
9.1	:LAN:DHCP	.....229
9.2	:LAN:AUTOip	.....230
9.3	:LAN:MANual	.....230
9.4	:LAN:IPADdress	.....231
9.5	:LAN:SMASK	.....232
9.6	:LAN:DSERver?	.....232
9.7	:LAN:GATeway	.....233
9.8	:LAN:DNS	.....234
9.9	:LAN:MAC?	.....234
9.10	:LAN:STATus?	.....235
9.11	:LAN:VISA?	.....236
9.12	:LAN:MDNS	.....236
9.13	:LAN:APPLY	.....237
9.14	:LAN:HOST:NAME	.....237
9.15	:LAN:DESCription	.....238
10	:MMEMory Commands	.....239

10.1	:MMEMory:STORe:LIMit	239
10.2	:MMEMory:STORe:CORRection	239
10.3	:MMEMory:STORe:STATe	240
10.4	:MMEMory:STORe:CSARchive	241
10.5	:MMEMory:STORe:DATA	241
10.6	:MMEMory:STORe:DATA:SNP	243
10.7	:MMEMory:LOAD:LIMit	244
10.8	:MMEMory:LOAD:CORRection	244
10.9	:MMEMory:LOAD:STATe	245
10.10	:MMEMory:LOAD:CSARchive	246
10.11	:MMEMory:LOAD:DATA:SNP	246
10.12	:MMEMory:CATalog:CORRection?	247
10.13	:MMEMory:CATalog:STATe?	247
10.14	:MMEMory:CATalog:CSARchive?	248
10.15	:MMEMory:CATalog:CSTate?	249
10.16	:MMEMory:CATalog[:File]?	249
10.17	:MMEMory:CATalog<char>? <folder>	250
10.18	:MMEMory:DISK:FORMat	251
10.19	:MMEMory:MDIRectory	251
10.20	:MMEMory:CDIRectory	252
11	:SYSTem Commands	253
11.1	:SYSTem:CHANnels:DELeTe	253
11.2	:SYSTem:BEEPer	253
11.3	:SYSTem:DATE	254
11.4	:SYSTem:TIME	254
11.5	:SYSTem:STIME	255
11.6	:SYSTem:LANGuage	256
11.7	:SYSTem:PSTatus	256
11.8	:SYSTem:RESet	257
11.9	:SYSTem:PWRD	257
11.10	:SYSTem:VERSion?	258
11.11	:SYSTem:LOCKed	258
11.12	:SYSTem:GPIB	259
11.13	:SYSTem:OPTion:INSTall	259
11.14	:SYSTem:OPTion:UNINStall	261
11.15	:SYSTem:OPTion:STATus?	261
11.16	:SYSTem:OPTion:VALid?	262

11.17	:SYSTem:PRESet	263
11.18	:SYSTem:ERRor?	263
11.19	:SYSTem:MACRo:COpy:CHANnel<cn>[:TO]	263
<b>12</b>	<b>:TRIGger Commands</b>	<b>265</b>
12.1	:TRIGger:DElay	265
12.2	:TRIGger[:SEquence]:SOURce	265
12.3	:TRIGger[:SEquence]:SCOpe	266
12.4	:TRIGger[:SEquence]:TYPE	267
12.5	:TRIGger[:SEquence]:SLOPe	267
12.6	:TRIGger:CHANnel<cn>:AUXiliary<an>[:ENABLE]	268
12.7	:TRIGger:CHANnel<cn>:AUXiliary<an>:OPOLarity	269
12.8	:TRIGger:CHANnel<cn>:AUXiliary<an>:POSition	270
12.9	:TRIGger:CHANnel<cn>:AUXiliary<an>:INTerval	270
12.10	:TRIGger:CHANnel<cn>:AUXiliary<an>:DURation	271
<b>13</b>	<b>:TAS Commands</b>	<b>273</b>
13.1	:TAS:STATe	273
13.2	:TAS:PATH	273
13.3	:TAS:DUT	274
13.4	:TAS:DUTConfig	274
<b>14</b>	<b>Other Commands</b>	<b>276</b>
14.1	:CONTRol:AUXiliary:PASSfail:POLicy	276
14.2	:OUTPut[:STATe]	276
14.3	:INITiate<cn>[:IMMEDIATE]	277
14.4	:ABORT	278
<b>15</b>	<b>Programming Examples</b>	<b>279</b>
15.1	Programming Preparations	279
15.2	Excel Programming Examples	279
15.3	LabVIEW Programming Example	283
15.4	Visual Basic Programming Example	288
15.5	Visual C++ Programming Example	290



# 1 Document Overview

This manual is your guide to programming DNA6000-R series vector network analyzer. DNA6000-R series can communicate with the PC via the USB, LAN, or GPIB interface.



## TIP

For the latest version of this manual, download it from the official website of RIGOL (<http://www.rigol.com>).

## Publication Number

PGR03100-1110

## Software Version

00.00.11

Software upgrade might change or add product features. Please acquire the latest version of the manual from RIGOL website or contact RIGOL to upgrade the software.

## Format Conventions in this Manual

### 1. Key

The front panel key is denoted by the menu key icon. For example,  indicates the "System" key.

### 2. Menu

The menu item is denoted by the format of "Menu Name (Bold) + Character Shading" in the manual. For example, **Frequency** indicates clicking **Frequency** to enter the frequency setting menu.

### 3. Operation Procedures

The next step of the operation is denoted by ">" in the manual. For example, **Frequency** > **Center** indicates first clicking **Frequency**, and then clicking **Center**.

## Content Conventions in this Manual

DNA6000-R series vector network analyzer includes the following models. Unless otherwise specified, this manual takes DNA6264-R as an example to illustrate the functions and operation methods of the DNA6000-R series.

Model	Frequency	Number of Channels	Connector
DNA6082-R	5 kHz to 8.5 GHz	2	N-type Female
DNA6084-R	5 kHz to 8.5 GHz	4	N-type Female

Model	Frequency	Number of Channels	Connector
DNA6142-R	5 kHz to 14 GHz	2	N-type Female
DNA6144-R	5 kHz to 14 GHz	4	N-type Female
DNA6202-R	5 kHz to 20 GHz	2	3.5mm Threaded Male Connector
DNA6204-R	5 kHz to 20 GHz	4	3.5mm Threaded Male Connector
DNA6262-R	5 kHz to 26.5 GHz	2	3.5mm Threaded Male Connector
DNA6264-R	5 kHz to 26.5 GHz	4	3.5mm Threaded Male Connector

## 2 Programming Overview

---

### 2.1 SCPI Command Overview

---

SCPI (Standard Commands for Programmable Instruments) is a standardized instrument programming language that is built upon the existing standard IEEE 488.1 and IEEE 488.2 and conforms to various standards, such as the floating point operation rule in IEEE 754 standard, ISO 646 7-bit coded character set for information interchange (equivalent to ASCII programming). The SCPI commands provide a hierarchical tree structure, and consist of multiple subsystems. Each command subsystem consists of one root keyword and one or more sub-keywords.

#### Syntax

The SCPI commands provide a hierarchical tree structure, and consist of multiple subsystems. Each command subsystem consists of one root keyword and one or more sub-keywords.

The command line usually starts with a colon; the keywords are separated by colons, and following the keywords are the parameter settings available. The command ending with a question mark indicates querying a certain function. The keywords of the command and the first parameter is separated by a space.

For example,

```
:SENSe:FREQuency:CENTer <freq>
```

```
:SENSe:FREQuency:CENTer?
```

SENSe is the root keyword of the command. FREQuency and CENTer are the second-level and third-level keywords respectively. The command line starts with ":", and a colon is also used to separate the multiple-level keywords. <freq> represents the parameters available for setting. "?" represents query. The command :SENSe:FREQuency:CENTer and the parameter <freq> are separated by a space.

#### Description

The following symbols are not sent with the commands.

##### 1. Braces { }

The contents in the braces can contain one or multiple parameters. These parameters can be omitted or used for several times. Parameters are usually separated by the vertical bar "|". When using the command, you must select one of the parameters.

##### 2. Vertical Bar |

The vertical bar is used to separate multiple parameters. When using the command, you must select one of the parameters.

In the command `:SYSTEM:BEEPer <bool>`, `<bool>` is a variable parameter. It can be set to `{{1|ON}}{0|OFF}}`. That is, select any one of the four available values for the parameter `<bool>`: OFF, ON, 0, or 1.

### 3. Square Brackets [ ]

The contents in the square brackets can be omitted.

For the command `:TRIGger[:SEquence]:TYPE?`, sending any of the following two commands can achieve the same effect.

```
:TRIGger[:SEquence]:TYPE?
```

```
:TRIGger:TYPE?
```

### 4. Angle Brackets < >

The parameter enclosed in the angle brackets must be replaced by an effective value.

The command line `:TRIGger:DElay 1` is sent for the `:TRIGger:DElay <time>` command.

## Parameter Type

### 1. Bool

The parameter can be set to ON, OFF, 1, or 0. For example,

```
:SYSTEM:BEEPer <bool>
```

```
:SYSTEM:BEEPer?
```

Wherein, `<bool>` can be set to `{{1|ON}}{0|OFF}}`. The query returns 1 or 0.

### 2. Discrete

The parameter can be any of the values listed. For example,

```
:SYSTEM:PStatus <sat>
```

```
:SYSTEM:PStatus?
```

Wherein,

- `<sat>` can be set to Default|OPEN.
- The query returns an abbreviated form: DEF or OPEN.

### 3. Integer

Unless otherwise specified, the parameter can be any integer (NR1 format) within the effective value range.

**CAUTION**

Do not set the parameter to a decimal, otherwise, errors will occur.

For example,

```
:SENSe<cn>:SWEep:POINTs <num>
```

```
:SENSe<cn>:SWEep:POINTs?
```

Wherein, *<num>* can be set to an integer ranging from 1 to 100001. The query returns an integer ranging from 1 to 100001.

**4. Real**

The parameter can be any real number within the effective value range, and this command accepts parameter input in decimal (NR2 format) and scientific notation (NR3 format). For example,

```
:TRIGger:DELaY <time>
```

```
:TRIGger:DELaY?
```

Wherein, *<time>* can be set to any real number ranging from 0 to 3E+0 (3 s). The query returns a real number in scientific notation.

**5. ASCII String**

The parameter can be the combinations of ASCII characters. For example,

```
:LAN:GATeway <string>
```

Wherein, *<string>* can be set to

```
192.168.1.1
```

**Command Abbreviation**

All the commands are case-insensitive. They can all be in upper case or in lower case. If abbreviation is used, you must input all the capital letters in the command. For example,

```
:LAN:IPADdress?
```

can be abbreviated to

```
:LAN:IPAD?
```

## 2.2 Remote Control

This instrument supports Web Control remote operation. Web Control is Web-based remote control operation. With Web control, you can access and operate the LAN-connected instrument via the web page on any smart terminals such as PC, mobile, and iPad, without needing to install any software. The operation procedures are as follows:

1. Connect the instrument to the network

Ensure that the rear-panel LAN interface is connected to the network. Note that the instrument must be connected to the network where the control terminal is located. Then you can operate the instrument in remote way by accessing the network.

2. Obtain the IP address

In the **System** menu, click **IO** to view the IP address of the instrument.

3. Input the IP address of the instrument into the browser address bar, then press Enter to access the web page, as shown in the following figure.

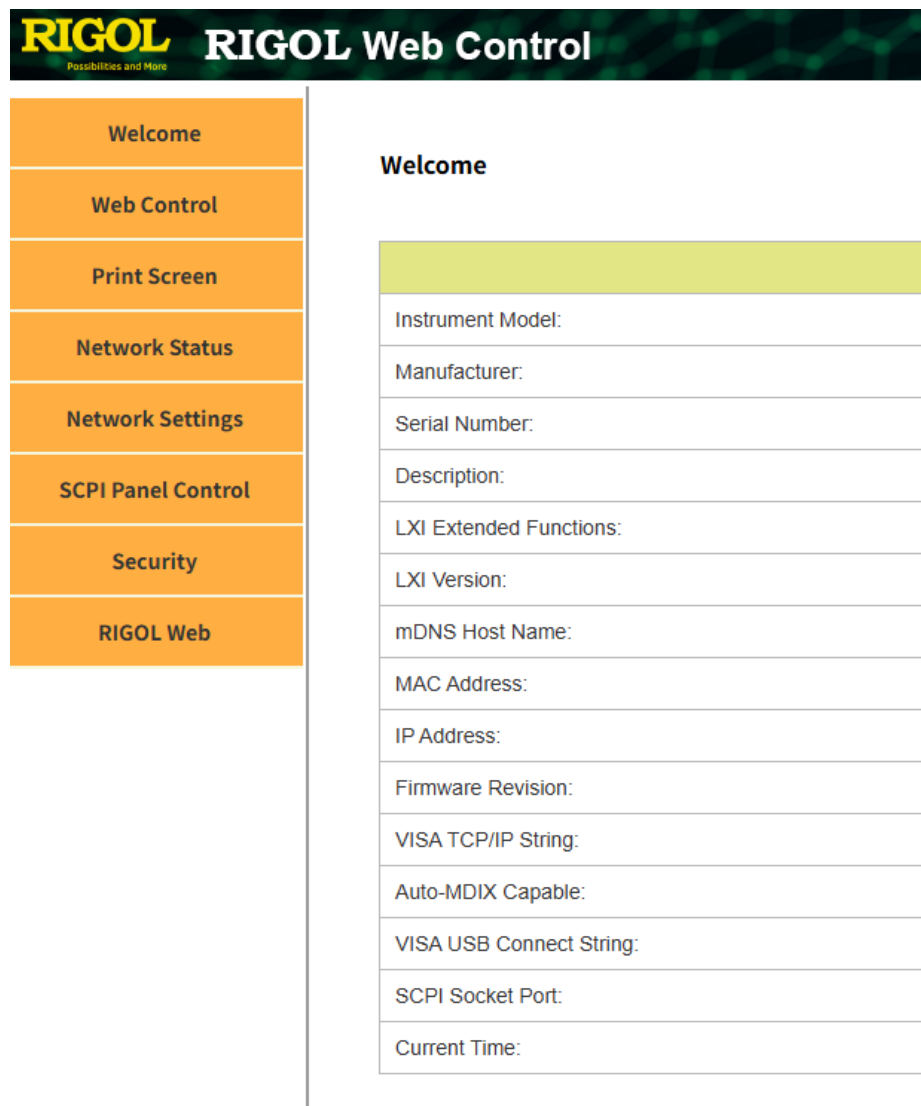

4. Click **Web Control** on the left side of the screen to enter the instrument remote control interface. You can use the mouse to remotely control the instrument in real time, with the same effect as operating the instrument directly.

5. Click **Print Screen**, and you can select "Take Screenshot" or "Record Screen" to capture the current screen shot.

6. Click **Network Settings** to configure the network. Note that login is required when changing the network configuration. When you first log in to the Web Control, use the user name "admin" and the password "rigol"..
7. The SCPI Panel Control function allows the user to send SCPI commands through the web interface for remote programming control of the instrument. Click **SCPI Panel Control** to enter the commands into the SCPI Command input field. After inputting the commands, click the **Send&Read** button to send the command and read the returned value.

You can program and control the instrument by using the SCPI (Standard Commands for Programmable Instruments) commands.

8. Close the browser to exit the instrument remote control interface.

Only one user can access the instrument IP address for remote control operation at a time. First come, first served. Concurrent logins are not allowed. If the connection is interrupted, you can refresh the browser to load the page.



#### **CAUTION**

**Before setting up communication, please turn off the instrument to avoid causing damage to the communication interfaces.**

### 3 IEEE488.2 Common Commands

The IEEE488.2 common commands are used to query the basic information of the instrument or executing basic operations. These commands usually start with "\*", and the command keywords contain 3 characters and are related with status registers.

The standard event status register (SESR) and status byte register (SBR) record the event of a certain type happened during the use of the instrument. IEEE488.2 defines to record one specific type of event for each bit in the status register.

**Table 3.1 Table of the Bit Definition of Standard Event Status Register**

Bit No.	Bit Name	Decimal Value	Description
0	Operation Complete (OPC)	1	"Operation complete" indicates that all pending operations were completed following the execution of the command.
1	Not Used	2	-
2	Query Error (QYE)	4	The instrument tries to read the output buffer but it was empty. Or, a new command line was received before a previous query has been read. Or, both the input buffer and output buffer are full.
3	Device-Specific Error (DDE)	8	Indicates that an error has occurred that is neither a Command Error, a Query Error, nor an Execution Error. A Device-Specific Error is any executed device operation that did not properly complete due to some condition, such as self-check error, calibration error, or other device-specific errors.
4	Execution Error (E)	16	An execution error occurred.
5	Command Error (CME)	32	A command error (command syntax error) has occurred.
6	Not Used	64	-
7	Power On (PON)	128	Indicates that an off-to-on transition has occurred in the device's power supply

Bit No.	Bit Name	Decimal Value	Description
			since last reading or the event register was cleared.

**Table 3.2 Table of the Bit Definition of Status Byte Register**

Bit No.	Bit Name	Decimal Value	Description
0	Not Used	1	-
1	Not Used	2	-
2	Error Queue	4	1 or multiple errors in the error queue
3	Questionable Data Summary	8	Sets 1 or multiple bits (must be the enabled bit) in the questionable data register.
4	Message Available (MAV)	16	Indicates the available data in the output buffer.
5	Standard Event Summary	32	Sets 1 or multiple bits (must be the enabled bit) in the standard event register.
6	Master Summary Status (MSS)	64	Sets 1 or multiple bits (must be the enabled bit) in the Status Byte Register and generate the service request.
7	Operation Status Register	128	Sets 1 or multiple bits (must be the enabled bit) in the Operation Status Register.

### 3.1 \*IDN?

#### Syntax

\*IDN?

#### Description

Queries the ID string of the instrument.

#### Parameter

N/A

**Remarks**

N/A

**Return Format**

The query returns RIGOL TECHNOLOGIES,<model>,<serial number>,<software version>.

- **<model>**: indicates the model number of the instrument.
- **<serial number>**: indicates the serial number of the instrument.
- **<software version>**: indicates the software version of the instrument.

**Example**

N/A

## 3.2 \*RST

**Syntax****\*RST****Description**

Restores the instrument to its factory default settings.

**Parameter**

N/A

**Remarks**

N/A

**Return Format**

N/A

**Example**

N/A

## 3.3 \*CLS

**Syntax****\*CLS****Description**

Clears all the event registers, and also clears the error queue.

**Parameter**

N/A

**Remarks**

N/A

**Return Format**

N/A

**Example**

N/A

## 3.4 \*ESE

**Syntax**`*ESE <maskargument>``*ESE?`**Description**

Sets or queries the enable register of the standard event register set.

**Parameter**

Name	Type	Range	Default
<maskargument>	Integer	0 to 255	0

**Remarks**

For the definitions of the bits in the standard event register, refer to [Table 3.1 Table of the Bit Definition of Standard Event Status Register](#). The value of <maskargument> is the sum of the decimal values of all bits set in the standard event register. For example, to enable Bit 2 (4 in decimal), Bit 3 (8 in decimal), and Bit 7 (128 in decimal), set the <maskargument> to 140 (4+8+128).

**Return Format**

The query returns an integer. The integer equals to the decimal-weighted sum of all the bits set in the register.

**Example**

```
*ESE 16 /*Enables Bit 4 (16 in decimal) in the register.*/
*ESE? /*The query returns the enable value of the register 16.*/
```

## 3.5 \*ESR?

### Syntax

\*ESR?

### Description

Queries and clears the event register of the standard event status register.

### Parameter

N/A

### Remarks

Bit 1 and Bit 6 in the standard event status register (*Table 3.1 Table of the Bit Definition of Standard Event Status Register*) are not used and are always treated as 0; therefore, the range of the returned value is a decimal number corresponding to a binary number X0XXXX0X (X is 1 or 0).

### Return Format

The query returns an integer. The integer equals to the binary-weighted sum of all the bits set in the register.

### Example

N/A

## 3.6 \*OPC

### Syntax

\*OPC

\*OPC?

### Description

The \*OPC command sets bit 0 (Operation Complete, OPC) in the standard event register to 1 after the current operation is finished.

The \*OPC? command queries whether the current operation is finished.

### Parameter

N/A

### Remarks

For the definitions of the bits in the standard event register, refer to *Table 3.1 Table of the Bit Definition of Standard Event Status Register*.

**Return Format**

The query returns 1 after the current operation is finished; otherwise, the query returns 0.

**Example**

N/A

**3.7 \*RCL****Syntax**

**\*RCL**

**Description**

Recalls instrument settings from the specified non-volatile memory. The previous saved settings through the **\*SAV** command will be overwritten.

**Parameter**

N/A

**Remarks**

N/A

**Return Format**

N/A

**Example**

N/A

**3.8 \*SAV****Syntax**

**\*SAV** <value>

**Description**

Saves the current instrument state to the selected register.

**Parameter**

Name	Type	Range	Default
<value>	Integer	0 to 49	0

**Remarks**

N/A

**Return Format**

N/A

**Example**

```
*SAV 1 /*Saves the current instrument state to Register 1.*/
```

**3.9 \*SRE****Syntax**

**\*SRE** <maskargument>

**\*SRE?**

**Description**

Sets or queries the enable register of the status byte register set.

**Parameter**

Name	Type	Range	Default
<maskargument>	Integer	0 to 255	0

**Remarks**

For the definitions of the bits in the status byte register, refer to [Table 3.2 Table of the Bit Definition of Status Byte Register](#). The value of <maskargument> is the sum of the decimal values of all bits set in the status byte register. For example, to enable Bit 2 (4 in decimal), Bit 3 (8 in decimal), and Bit 7 (128 in decimal), set the <maskargument> to 140 (4+8+128).

**Return Format**

The query returns an integer. The integer equals to the decimal-weighted sum of all the bits set in the register.

**Example**

```
*SRE 16 /*Enables Bit 4 (16 in decimal) in the register.*/
*SRE? /*The query returns the enable value of the register 16.*/
```

**3.10 \*STB?****Syntax**

**\*STB?**

**Description**

Queries the event register for the status byte register. After executing the command, the value in the status byte register is cleared.

**Parameter**

N/A

**Remarks**

Bit 0 and Bit 1 in the status byte register (*Table 3.2 Table of the Bit Definition of Status Byte Register*) are not used and are always treated as 0; therefore, the range of the returned value is a decimal number corresponding to a binary number XXXXXX00 (X is 1 or 0).

**Return Format**

The query returns an integer. The integer equals to the decimal-weighted sum of all the bits set in the register.

**Example**

N/A

### 3.11 \*WAI

**Syntax****\*WAI****Description**

Waits for all the pending operations to complete before executing any additional commands.

**Parameter**

N/A

**Remarks**

This operation command does not have any functions, only to be compatible with other devices.

**Return Format**

N/A

**Example**

N/A

### 3.12 \*TST?

**Syntax****\*TST?**

**Description**

Performs a self-test and queries the self-test result.

**Parameter**

N/A

**Remarks**

This command performs a self-test. If the test fails, one or multiple error messages will be displayed.

**Return Format**

The query returns 0 or 1.

- **0**: passed the test.
- **1**: one or multiple tests failed.

**Example**

N/A

### 3.13 :GPIB:PARSe:END

**Syntax**

:GPIB:PARSe:END

**Description**

Sends the "Parse End" command to the GPIB module. After sending this command, the USB-GPIB adapter module can work normally.

**Parameter**

N/A

**Remarks**

N/A

**Return Format**

N/A

**Example**

N/A

## 4 :SOURce<cn> Commands

The :SOURce<cn> commands are used to set and query the source power related parameters. Wherein, <cn> indicates the existing channel number.

### 4.1 :SOURce<cn>:POWer<pn>[:LEVel][:IMMediate][:AMPLitude]

#### Syntax

```
:SOURce<cn>:POWer<pn>[:LEVel][:IMMediate][:AMPLitude] <value>
```

```
:SOURce<cn>:POWer<pn>[:LEVel][:IMMediate][:AMPLitude]?
```

#### Description

Sets the output power for the specified channel.

Queries the output power for the specified channel.

#### Parameter

Name	Type	Range	Default
<cn>	Integer	1 to 500	1
<pn>	Integer	Refer to Remarks	1
<value>	Real	-40 dBm to 10 dBm	-5 dBm

#### Remarks

- For DNA6082-R, DNA6142-R, DNA6202-R, and DNA6262-R, <pn> can be set to 1 or 2.
- For DNA6084-R, DNA6144-R, DNA6204-R, and DNA6264-R, <pn> can be set to 1, 2, 3, or 4.
- Running this command can configure the output power, and this command is valid for all the ports. The parameter <pn> does not have any actual effects.

#### Return Format

The query returns the output power for the specified channel in scientific notation. The unit is dBm.

**Example**

```
:SOURce1:POWer1 0.5 /*Sets the output power on the ports for
Channel 1 to 0.5 dBm.*/
:SOURce1:POWer1? /*The query returns 5.00e-01.*/
```

**4.2 :SOURce<cn>:POWer[:LEVel][:AMPLitude]****Syntax**

```
:SOURce<cn>:POWer[:LEVel][:AMPLitude] <value>
```

```
:SOURce<cn>:POWer[:LEVel][:AMPLitude]?
```

**Description**

Sets the output power for the specified channel.

Queries the output power for the specified channel.

**Parameter**

Name	Type	Range	Default
<cn>	Integer	1 to 500	1
<value>	Real	-40 dBm to 10 dBm	-5 dBm

**Remarks**

Run this command to configure the output power, which is valid for all the ports.

**Return Format**

The query returns the output power for the specified channel in scientific notation. The unit is dBm.

**Example**

```
:SOURce1:POWer 0.5 /*Sets the output power on the ports for Channel
1 to 0.5 dBm.*/
:SOURce1:POWer? /*The query returns 5.00e-01.*/
```

**4.3 :SOURce<cn>:POWer<pn>:STARt****Syntax**

```
:SOURce<cn>:POWer<pn>:STARt <value>
```

```
:SOURce<cn>:POWer<pn>:STARt?
```

**Description**

Sets the start power on all the ports used for the specified channel.

Queries the start power on all the ports used for the specified channel.

**Parameter**

Name	Type	Range	Default
<cn>	Integer	1 to 500	1
<pn>	Integer	Refer to Remarks	1
<value>	Real	-40 dBm to +10 dBm	-20 dBm

**Remarks**

- For DNA6082-R, DNA6142-R, DNA6202-R, and DNA6262-R, <pn> can be set to 1 or 2.
- For DNA6084-R, DNA6144-R, DNA6204-R, and DNA6264-R, <pn> can be set to 1, 2, 3, or 4.
- The parameter <pn> does not function in this command.
- To run this command, first run the *:SENSe<cn>:SWEep:TYPE* command to set the sweep type to Power.

This command exists for backwards compatibility. Use the command *#unique\_26*.

**Return Format**

The query returns the start power of all ports for the specified channel in scientific notation. The unit is dBm.

**Example**

```
:SOURce1:POWer1:START 0.5 /*Sets the start power on the port for
Channel 1 to 0.5 dBm.*/
:SOURce1:POWer1:START? /*The query returns 5.00e-01.*/
```

## 4.4 :SOURce<cn>:POWer<pn>:STOP

**Syntax**

```
:SOURce<cn>:POWer<pn>:STOP <value>
```

```
:SOURce<cn>:POWer<pn>:STOP?
```

**Description**

Sets the stop power on all the ports used for the specified channel.

Queries the stop power on all the ports used for the specified channel.

**Parameter**

Name	Type	Range	Default
<cn>	Integer	1 to 500	1
<pn>	Integer	Refer to Remarks	1
<value>	Real	-40 dBm to +10 dBm	-5 dBm

**Remarks**

- For DNA6082-R, DNA6142-R, DNA6202-R, and DNA6262-R, <pn> can be set to 1 or 2.
- For DNA6084-R, DNA6144-R, DNA6204-R, and DNA6264-R, <pn> can be set to 1, 2, 3, or 4.
- The parameter <pn> does not function in this command.
- To run this command, first run the *:SENSe<cn>:SWEep:TYPE* command to set the sweep type to Power.

This command exists for backwards compatibility. Use the command *#unique\_28*.

**Return Format**

The query returns the stop power of all ports for the specified channel in scientific notation. The unit is dBm.

**Example**

```
:SOURce1:POWer1:STOP 0.5 /*Sets the stop power on the port for
Channel 1 to 0.5 dBm.*/
:SOURce1:POWer1:STOP? /*The query returns 5.00e-01.*/
```

## 5 :Display Commands

### 5.1 :DISPlay:TRACe:NEW

#### Syntax

```
:DISPlay:TRACe:NEW <num>
```

#### Description

Creates a trace, a channel, or a window.

#### Parameter

Name	Type	Range	Default
<num>	Integer	0 to 3	0

#### Remarks

Different values of <num> correspond to different definitions.

- 0: creates a trace (default).
- 1: creates a trace on a new channel.
- 2: creates a trace in a new window.
- 3: creates a trace, a channel, and a window.

#### Return Format

N/A

#### Example

```
:DISPlay:TRACe:NEW 1 /*Creates a channel and adds a new trace on  
the new channel.*/
```

### 5.2 :Display:MEASure Commands

The :Display:MEASure commands are used to set and query measurement trace parameters.

#### 5.2.1 :DISPlay:MEASure<mn>:DELeTe

#### Syntax

```
:DISPlay:MEASure<mn>:DELeTe
```

**Description**

Delete the specified measurement trace.

**Parameter**

Name	Type	Range	Default
<mn>	Integer	1 to 50000	1

**Remarks**

<mn>: indicates the trace number. Each trace corresponds to a unique trace number.

**Return Format**

N/A

**Example**

N/A

## 5.2.2 :DISPlay:MEASure<mn>[:STATe]

**Syntax**

```
:DISPlay:MEASure<mn>[:STATe] <bool>
```

```
:DISPlay:MEASure<mn>[:STATe]?
```

**Description**

Enables or disables the display of the specified measurement trace.

Queries whether to display the specified measurement trace.

**Parameter**

Name	Type	Range	Default
<mn>	Integer	1 to 50000	1
<bool>	Bool	{{1 ON}} {{0 OFF}}	0 OFF

**Remarks**

N/A

**Return Format**

The query returns 1 or 0.

**Example**

```
:DISPlay:MEASure1 ON /*Enables the display of measurement trace 1.*/
```

```
:DISPlay:MEASure1? /*The query returns 1.*/
```

### 5.2.3 :DISPlay:MEASure<mn>:SElect

#### Syntax

```
:DISPlay:MEASure<mn>:SElect
```

#### Description

Activates the measurement for the specified trace. The trace is selected.

#### Parameter

Name	Type	Range	Default
<mn>	Integer	1 to 50000	1

#### Remarks

<mn>: indicates the trace number. Each trace corresponds to a unique trace number.

#### Return Format

N/A

#### Example

N/A

### 5.2.4 :DISPlay:MEASure<mn>:TITLE:DATA

#### Syntax

```
:DISPlay:MEASure<mn>:TITLE:DATA <string>
```

```
:DISPlay:MEASure<mn>:TITLE:DATA?
```

#### Description

Sets the title for the specified measurement trace.

Queries the title for the specified measurement trace.

#### Parameter

Name	Type	Range	Default
<mn>	Integer	1 to 50000	1
<string>	ASCII String	-	-

#### Remarks

The length of the title cannot exceed 70 characters.

**Return Format**

The query returns the title of the specified trace in strings.

**Example**

```
:DISPlay:MEASure1:TITLe:DATA test1 /*Sets the title of measurement
trace 1 to test1.*/
:DISPlay:MEASure1:TITLe:DATA? /*The query returns "test1".*/
```

**5.2.5 :DISPlay:MEASure<mn>:TITLe[:STATe]****Syntax**

```
:DISPlay:MEASure<mn>:TITLe[:STATe] <bool>
```

```
:DISPlay:MEASure<mn>:TITLe[:STATe]?
```

**Description**

Enables or disables the display of the title of the specified measurement trace.

Queries whether to display the title of the specified measurement trace.

**Parameter**

Name	Type	Range	Default
<mn>	Integer	1 to 50000	1
<bool>	Bool	{{1 ON}} {{0 OFF}}	0 OFF

**Remarks**

N/A

**Return Format**

The query returns 1 or 0.

**Example**

```
:DISPlay:MEASure1:TITLe ON /*Enables the display of the title of
measurement trace 1.*/
:DISPlay:MEASure1:TITLe? /*The query returns 1.*/
```

**5.2.6 :DISPlay:MEASure<mn>:Y[:SCALE]:PDIVision****Syntax**

```
:DISPlay:MEASure<mn>:Y[:SCALE]:PDIVision <value>
```

```
:DISPlay:MEASure<mn>:Y[:SCALE]:PDIVision?
```

**Description**

Sets the Y-axis scale of the specified trace.

Queries the Y-axis scale of the specified trace.

#### Parameter

Name	Type	Range	Default
<mn>	Integer	1 to 50000	1
<value>	Real	Refer to Remarks	-

#### Remarks

The value, unit, and default settings of the parameter <value> are related to the data format (`:CALCulate<cn>:MEASure<mn>:FORMat`) of the measurement parameter.

#### Return Format

The query returns the Y-axis scale per division in scientific notation.

#### Example

```
:DISPlay:MEASure1:Y:PDIVision 0.005 /*Sets the Y-axis scale for
the measurement trace 1 to 0.005.*/
:DISPlay:MEASure1:Y:PDIVision? /*The query returns 5.00e-03.*/
```

## 5.2.7 :DISPlay:MEASure<mn>:Y[:SCALE]:RLEVel

#### Syntax

```
:DISPlay:MEASure<mn>:Y[:SCALE]:RLEVel <value>
```

```
:DISPlay:MEASure<mn>:Y[:SCALE]:RLEVel?
```

#### Description

Sets the Y-axis reference value of the specified trace.

Queries the Y-axis reference value of the specified trace.

#### Parameter

Name	Type	Range	Default
<mn>	Integer	1 to 50000	1
<value>	Real	Refer to Remarks	-

#### Remarks

The value and unit of the parameter <value> are related to the data format (`:CALCulate<cn>:MEASure<mn>:FORMat`) of the measurement parameters.

#### Return Format

The query returns the Y-axis reference value of the specified trace in scientific notation.

**Example**

```
:DISPlay:MEASure1:Y:RLEVel 0.5 /*Sets the Y-axis reference value
of measurement trace 1 to 0.5 V.*/
:DISPlay:MEASure1:Y:RLEVel? /*The query returns 5.00e-01.*/
```

**5.2.8 :DISPlay:MEASure<mn>:Y[:SCALE]:RPOsition****Syntax**

```
:DISPlay:MEASure<mn>:Y[:SCALE]:RPOsition <value>
```

```
:DISPlay:MEASure<mn>:Y[:SCALE]:RPOsition?
```

**Description**

Sets the reference position of the specified measurement trace.

Queries the reference position of the specified measurement trace.

**Parameter**

Name	Type	Range	Default
<mn>	Integer	1 to 50000	1
<value>	Real	0 to 10	-

**Remarks**

The default value of the parameter <value> is related to the data format (*:CALCulate<cn>:MEASure<mn>:FORMat*) of the measurement parameter.

**Return Format**

The query returns the reference position of the specified trace in scientific notation.

**Example**

```
:DISPlay:MEASure1:Y:RPOsition 0.005 /*Sets the reference position
of measurement trace 1 to 0.005.*/
:DISPlay:MEASure1:Y:RPOsition? /*The query returns 5.00e-03.*/
```

**5.3 :Display:CHANnel Commands**

The :Display:CHANnel commands are used to set and query the channel related parameters.

**5.3.1 :DISPlay:CHANnel:NEW****Syntax**

```
:DISPlay:CHANnel:NEW <num>
```

**Description**

Adds New Trace + Channel or adds New Trace + Channel + Window.

**Parameter**

Name	Type	Range	Default
<num>	Integer	0 to 1	0

**Remarks**

- 0: Adds New Trace + Channel.
- 1: Adds New Trace + Channel + Window.

**Return Format**

N/A

**Example**

```
:DISPlay:CHANnel:NEW 1 /*Adds New Trace + Channel + WIndow.*/
```

### 5.3.2 :DISPlay:CHANnel<cn>:STATe

**Syntax**

```
:DISPlay:CHANnel<cn>:STATe <bool>
```

```
:DISPlay:CHANnel<cn>:STATe?
```

**Description**

Enables or disables the specified channel.

Queries the on/off status of the specified channel.

**Parameter**

Name	Type	Range	Default
<cn>	Integer	1 to 500	1
<bool>	Bool	{{1 ON}}{0 OFF}}	0 OFF

**Remarks**

- When <bool> is set to ON, the specified channel <cn> is added to the current active window. If no window exists, then a new window is created. If the specified channel <cn> does not exist, then the channel is created. If the specified channel exists, then the channel will be selected as the active channel.

- When <bool> is set to OFF, if the specified channel <cn> already exists, then it will be deleted.

### Return Format

The query returns 1 or 0.

### Example

```
:DISPlay:CHANnel1:STATe ON /*Enables Channel 1 and adds it to the
current window.*/
:DISPlay:CHANnel1:STATe? /*The query returns 1.*/
```

## 5.4 :Display:WINDow Commands

The :Display:WINDow commands are used to set and query the window related function.

### 5.4.1 :DISPlay:WINDow:NEW

#### Syntax

```
:DISPlay:WINDow:NEW <value>
```

#### Description

Adds a window; adds a channel or a trace in the window.

#### Parameter

Name	Type	Range	Default
<value>	Integer	0 to 2	0

#### Remarks

- 0: Adds a new window.
- 1: Adds a trace in a new window.
- 2: Adds a trace and a channel to a new window.

#### Return Format

N/A

#### Example

N/A

## 5.4.2 :DISPlay:WINDow:TRACe:GRATicule:GRID:LTYPE

### Syntax

```
:DISPlay:WINDow:TRACe:GRATicule:GRID:LTYPE <enum>
```

```
:DISPlay:WINDow:TRACe:GRATicule:GRID:LTYPE?
```

### Description

Sets the grid line type of the window.

Queries the grid line type of the window.

### Parameter

Name	Type	Range	Default
<enum>	Discrete	{SOLid DOTTed}	SOLid

### Remarks

- SOLid: the grid is represented in solid line.
- DOTTed: the grid is represented in dotted line.

### Return Format

The query returns SOL or DOTT.

### Example

```
:DISPlay:WINDow:TRACe:GRATicule:GRID:LTYPE DOTTed /*Sets the grid
line type of all the windows to dotted lines.*/
:DISPlay:WINDow:TRACe:GRATicule:GRID:LTYPE? /*The query returns
DOTT.*/
```

## 5.4.3 :DISPlay:WINDow<wn>:TRACe<tn>:Y[:SCALE]:AUTO

### Syntax

```
:DISPlay:WINDow<wn>:TRACe<tn>:Y[:SCALE]:AUTO
```

### Description

Enables or disables the auto scaling of the specified measurement trace in the specified window.

### Parameter

Name	Type	Range	Default
<wn>	Integer	1 to 500	1
<tn>	Integer	1 to 50000	1

**Remarks**

N/A

**Return Format**

N/A

**Example**

N/A

**5.4.4 :DISPlay:WINDow<wn>:TRACe<tn>:Y[:SCALE]:PDIVision****Syntax**

```
:DISPlay:WINDow<wn>:TRACe<tn>:Y[:SCALE]:PDIVision <value>
```

```
:DISPlay:WINDow<wn>:TRACe<tn>:Y[:SCALE]:PDIVision?
```

**Description**

Sets the Y-axis scale per division for the specified trace in the specified window.

Queries the Y-axis scale per division for the specified trace in the specified window.

**Parameter**

Name	Type	Range	Default
<wn>	Integer	1 to 500	1
<tn>	Integer	1 to 50000	1
<value>		Refer to Remarks	-

**Remarks**

The parameter value and its unit are related to the data format of the trace in the specified window.

**Return Format**

The query returns the Y-axis scale value in scientific notation.

**Example**

```
:DISPlay:WINDow1:TRACe1:Y:PDIVision 3 /*Sets the Y scale/div for
Trace 1 in Window 1 to 3.*/
:DISPlay:WINDow1:TRACe1:Y:PDIVision? /*The query returns 3.0e+00.*/
```

**5.4.5 :DISPlay:WINDow<wn>:TRACe<tn>:Y[:SCALE]:RLEVel****Syntax**

```
:DISPlay:WINDow<wn>:TRACe<tn>:Y[:SCALE]:RLEVel <value>
```

```
:DISPlay:WINDow<wn>:TRACe<tn>:Y[:SCALE]:RLEVel?
```

### Description

Sets the Y-axis reference value for the specified trace in the specified window.

Queries the Y-axis reference value for the specified trace in the specified window.

### Parameter

Name	Type	Range	Default
<wn>	Integer	1 to 500	1
<tn>	Integer	1 to 50000	1
<value>		Refer to Remarks	-

### Remarks

The parameter <value> and its unit are related to the data format of the trace in the specified window.

### Return Format

The query returns the Y-axis reference value for the specified trace in the specified window in scientific notation.

### Example

```
:DISPlay:WINDow1:TRACe1:Y:RLEVel 3 /*Sets the Y-axis reference
value to 3.*/
:DISPlay:WINDow1:TRACe1:Y:RLEVel? /*The query returns 3.0e+00.*/
```

## 5.4.6 :DISPlay:WINDow<wn>:TRACe<tn>:Y[:SCALE]:RPOStion

### Syntax

```
:DISPlay:WINDow<wn>:TRACe<tn>:Y[:SCALE]:RPOStion <value>
```

```
:DISPlay:WINDow<wn>:TRACe<tn>:Y[:SCALE]:RPOStion?
```

### Description

Sets the Y-axis reference position for the specified trace in the specified window.

Queries the Y-axis reference position for the specified trace in the specified window.

### Parameter

Name	Type	Range	Default
<wn>	Integer	1 to 500	1
<tn>	Integer	1 to 50000	1

Name	Type	Range	Default
<value>		0 to 10	5

**Remarks**

N/A

**Return Format**

The query returns the Y-axis reference position in scientific notation.

**Example**

```
:DISPlay:WINDow1:TRACe1:Y:RPOsition 3 /*Sets the Y-axis reference
position to 3.*/
:DISPlay:WINDow1:TRACe1:Y:RPOsition? /*The query returns 3.0e+00.*/
```

## 5.4.7 :DISPlay:WINDow<wn>:TRACe<tn>[:STATe]

**Syntax**

```
:DISPlay:WINDow<wn>:TRACe<tn>[:STATe] <bool>
```

```
:DISPlay:WINDow<wn>:TRACe<tn>[:STATe]?
```

**Description**

Enables or disables the display of the specified measurement trace in the specified window.

Queries whether to display the specified measurement trace in the specified window.

**Parameter**

Name	Type	Range	Default
<wn>	Integer	1 to 500	1
<tn>	Integer	1 to 50000	1
<bool>	Bool	{{1 ON}}{0 OFF}}	1 ON

**Remarks**

N/A

**Return Format**

The query returns 1 or 0.

**Example**

```
:DISPlay:WINDow1:TRACe1 ON /*Enables the display of Trace 1 in
Window 1.*/
:DISPlay:WINDow1:TRACe1? /*The query returns 1.*/
```

## 5.4.8 :DISPlay:WINDow<wn>:TRACe<tn>:MEMory[:STATe]

### Syntax

```
:DISPlay:WINDow<wn>:TRACe<tn>:MEMory[:STATe] <bool>
```

```
:DISPlay:WINDow<wn>:TRACe<tn>:MEMory[:STATe] ?
```

### Description

Enables or disables the display of the specified memory trace in the specified window.

Queries whether to display the specified memory trace in the specified window.

### Parameter

Name	Type	Range	Default
<wn>	Integer	1 to 500	1
<tn>	Integer	1 to 50000	1
<bool>	Bool	{{1 ON}}{0 OFF}}	0 OFF

### Remarks

N/A

### Return Format

The query returns 1 or 0.

### Example

```
:DISPlay:WINDow1:TRACe1 ON /*Enables the display of memory trace 1
in the Window1.*/
:DISPlay:WINDow1:TRACe1? /*The query returns 1.*/
```

## 5.4.9 :DISPlay:WINDow<wn>[:STATe]

### Syntax

```
:DISPlay:WINDow<wn>[:STATe] <bool>
```

```
:DISPlay:WINDow<wn>[:STATe] ?
```

### Description

Enables or disables the display of the specified window.

Queries whether the specified window is displayed.

### Parameter

Name	Type	Range	Default
<wn>	Integer	1 to 500	1

Name	Type	Range	Default
<bool>	Bool	{{1 ON}} {{0 OFF}}	0 OFF

**Remarks**

- When <bool> is set to ON, if the specified window with window No. <wn> does not exist, then a new window will be created.
- When <bool> is set to OFF, if the specified window <wn> already exists, then it will be deleted.

**Return Format**

The query returns 1 or 0.

**Example**

```
:DISPlay:WINDow1 ON /*Enables the display of Window1.*/
:DISPlay:WINDow1? /*The query returns 1.*/
```

## 5.4.10 :DISPlay:WINDow<wn>:Y:AUTO

**Syntax**

```
:DISPlay:WINDow:TRACe<wn>:Y:AUTO
```

**Description**

Enables or disables the auto scaling of all the traces in the specified window.

**Parameter**

Name	Type	Range	Default
<wn>	Integer	1 to 500	1

**Remarks**

N/A

**Return Format**

N/A

**Example**

N/A

## 5.4.11 :DISPlay:WINDow<wn>:Y[:SCALE]:DIVisions?

**Syntax**

```
:DISPlay:WINDow<wn>:TRACe<tn>:Y[:SCALE]:DIVisions?
```

**Description**

Queries the Y-axis scale per division for the specified trace in the specified window.

**Parameter**

Name	Type	Range	Default
<wn>	Integer	1 to 500	1

**Remarks**

N/A

**Return Format**

The query returns the Y-axis scale per division in integer.

**Example**

N/A

## 5.4.12 :DISPlay:WINDow<wn>:TITLe:DATA

**Syntax**

```
:DISPlay:WINDow<wn>:TITLe:DATA <string>
```

```
:DISPlay:WINDow<wn>:TITLe:DATA?
```

**Description**

Sets the title of the specified window.

Queries the title of the specified window.

**Parameter**

Name	Type	Range	Default
<wn>	Integer	1 to 500	1
<string>	ASCII String	-	-

**Remarks**

The length of the window title cannot exceed 70 characters.

**Return Format**

The query returns the title of the specified window in strings.

**Example**

```
:DISPlay:WINDow1:TITLe:DATA test1 /*Sets the title of Window1 to test1.*/
:DISPlay:WINDow1:TITLe:DATA? /*The query returns "test1".*/
```

### 5.4.13 :DISPlay:WINDow<wn>:TITLe[:STATe]

#### Syntax

```
:DISPlay:WINDow<wn>:TITLe[:STATe] <bool>
```

```
:DISPlay:WINDow<wn>:TITLe[:STATe]?
```

#### Description

Enables or disables the display of the title of the specified window.

Queries whether the title of the specified window is displayed.

#### Parameter

Name	Type	Range	Default
<wn>	Integer	1 to 500	1
<bool>	Bool	{{1 ON}}{0 OFF}}	0 OFF

#### Remarks

N/A

#### Return Format

The query returns 1 or 0.

#### Example

```
:DISPlay:WINDow1:TITLe ON /*Enables the display of the title of
Window1.*/
:DISPlay:WINDow1:TITLe? /*The query returns 1.*/
```

### 5.4.14 :DISPlay:WINDow<wn>:TABLe

#### Syntax

```
:DISPlay:WINDow<wn>:TABLe <type>
```

```
:DISPlay:WINDow<wn>:TABLe?
```

#### Description

Sets the table type displayed below the specified window.

Queries the table type currently displayed below the specified window.

#### Parameter

Name	Type	Range	Default
<wn>	Integer	1 to 500	1
<type>	Discrete	{OFF MARKer LIMit SEGment}	OFF

**Remarks**

- OFF: no table is displayed.
- MARKer: displays the marker table.
- LIMit: displays the limit test table.
- SEGMENT: displays the segment control table.

**Return Format**

The query returns OFF, MARK, LIM, or SEGM.

**Example**

```
:DISPlay:WINDow1:TABLE MARKer /*Sets the table type displayed
below WINDow1 to MARKer.*/
:DISPlay:WINDow1:TABLE? /*The query returns MARK.*/
```

## 5.4.15 :DISPlay:WINDow<wn>:CATalog?

**Syntax**

```
:DISPlay:WINDow<wn>:CATalog?
```

**Description**

Queries the trace number of the specified window.

**Parameter**

Name	Type	Range	Default
<wn>	Integer	1 to 500	1

**Remarks**

If no trace is found in the specified window, the query returns EMPTY.

**Return Format**

The query returns the trace number in strings, separated by commas.

**Example**

```
:DISPlay:WINDow1:CATalog? /*The query returns 1,2,3,4.*/
```

## 5.5 :Display:SHEet Commands

The :Display:SHEet commands are used to set and query the sheet related parameters.

## 5.5.1 :DISPlay:SHEet:NEW

### Syntax

```
:DISPlay:SHEet:NEW <num>
```

### Description

Creates New Sheet, New Trace + Sheet, or New Trace + Channel + Sheet.

### Parameter

Name	Type	Range	Default
<num>	Integer	0 to 2	1

### Remarks

- 0: New Sheet. Creates a new sheet.
- 1: New Trace + Sheet. Creates a new sheet in a new window and creates a trace.
- 2: New Trace + Channel + Sheet. Creates a new sheet in a new window, creates a new channel and a trace.

### Return Format

N/A

### Example

N/A

## 5.5.2 :DISPlay:SHEet<shnum>:STATe

### Syntax

```
:DISPlay:SHEet<shnum>:STATe <bool>
```

```
:DISPlay:SHEet<shnum>:STATe?
```

### Description

Creates or activates the specified sheet.

Queries the current state of the specified sheet.

### Parameter

Name	Type	Range	Default
<shnum>	Integer	1 to 50000	1
<bool>	Bool	{{1 ON}} {{0 OFF}}	0 OFF

**Remarks**

- When <bool> is set to ON, if the specified sheet exists, then this sheet is the active sheet. If the specified sheet does not exist, then a new sheet will be created and this sheet becomes the activate sheet.
- When <bool> is set to OFF, if the specified sheet already exists, then the sheet will be deleted, but the last sheet will not be deleted.

**Return Format**

The query returns 1 or 0.

**Example**

```
:DISPlay:SHEet1:STATE ON /*Activates Sheet1.*/
:DISPlay:SHEet1:STATE? /*The query returns 1.*/
```

### 5.5.3 :DISPlay:SHEet<shnum>:TITLE:DATA

**Syntax**

```
:DISPlay:SHEet<shnum>:TITLE:DATA <string>
```

```
:DISPlay:SHEet<shnum>:TITLE:DATA?
```

**Description**

Sets the title of the specified sheet.

Queries the title of the specified sheet.

**Parameter**

Name	Type	Range	Default
<shnum>	Integer	1 to 50000	1
<string>	ASCII String	-	"Sheet1"

**Remarks**

The length of the sheet title cannot exceed 70 characters.

**Return Format**

The query returns the sheet title in strings.

**Example**

```
:DISPlay:SHEet1:TITLe:DATA test1 /*Sets the title of Sheet1 to
test1.*/
:DISPlay:SHEet1:TITLe:DATA? /*The query returns "test1".*/
```

## 5.6 :DISPlay:FSIGn

### Syntax

```
:DISPlay:FSIGn <bool>
```

```
:DISPlay:FSIGn?
```

### Description

Enables or disables the display of the global pass/fail results.

Queries the on/off status of the display of the global pass/fail results.

### Parameter

Name	Type	Range	Default
<bool>	Bool	{{1 ON}}{0 OFF}}	0 OFF

### Remarks

N/A

### Return Format

The query returns 1 or 0.

### Example

```
:DISPlay:FSIGn ON /*Enables the display of the global pass/fail
results.*/
:DISPlay:FSIGn? /*The query returns 1.*/
```

## 5.7 :DISPlay:LIMit:GLOBal:FAIL?

### Syntax

```
:DISPlay:LIMit:GLOBal:FAIL?
```

### Description

Queries the test result of the global pass/fail test.

### Parameter

N/A

### Remarks

If the global pass/fail test (:DISPlay:FSIGn) is disabled, the query always returns 0.

### Return Format

The query returns 0 or 1. 1 indicates failed.

**Example**

N/A

## 5.8 :DISPlay:LIMit:GLOBal:FAIL:TRACes?

**Syntax**

```
:DISPlay:LIMit:GLOBal:FAIL:TRACes?
```

**Description**

Queries the trace number of the failed trace in the limit line test.

**Parameter**

N/A

**Remarks**

If the global pass/fail test (:DISPlay:FSIGn) is disabled or no failed traces are found, the query returns no value.

**Return Format**

The query returns the trace number of the failed trace in the limit line test, separated by commas. If no failed traces are found, the query does not return any value.

**Example**

```
:DISPlay:LIMit:GLOBal:FAIL:TRACes? /*The query returns Tr1,Tr3.*/
```

## 6 :SENSe<cn> Commands

<cn> indicates the existing channel number.

### 6.1 :SENSe<cn>:FREQuency Commands

The :SENSe<cn>:FREQuency commands are used to set and query the frequency related parameters.

#### 6.1.1 :SENSe<cn>:FREQuency:START

##### Syntax

```
:SENSe<cn>:FREQuency:START <freq>
```

```
:SENSe<cn>:FREQuency:START?
```

##### Description

Sets the start frequency for the specified channel.

Queries the start frequency for the specified channel.

##### Parameter

Name	Type	Range	Default
<cn>	Integer	1 to 500	1
<freq>	Real	Refer to Remarks	10 MHz

##### Remarks

This command is valid when the sweep type (:SENSe<cn>:SWEep:TYPE) is set to LINear or LOGarithmic.

The range of the <freq> parameter is related to the product model. For the product model, refer to product model table.

##### Return Format

The query returns the start frequency in scientific notation. The unit is Hz.

##### Example

```
:SENSe1:FREQuency:START 10000000 /*Sets the start frequency to 10 MHz.*/
:SENSe1:FREQuency:START? /*The query returns 1.00e+07.*/
```

## 6.1.2 :SENSe<cn>:FREQuency:STOP

### Syntax

```
:SENSe<cn>:FREQuency:STOP <freq>
```

```
:SENSe<cn>:FREQuency:STOP?
```

### Description

Sets the stop frequency for the specified channel.

Queries the stop frequency for the specified channel.

### Parameter

Name	Type	Range	Default
<cn>	Integer	1 to 500	1
<freq>	Real	Refer to Remarks	-

### Remarks

This command is valid when the sweep type (:SENSe<cn>:SWEep:TYPE) is set to LINear or LOGarithmic.

The range of the <freq> parameter is related to the product model. For the product model, refer to product model table.

### Return Format

The query returns the stop frequency in scientific notation. The unit is Hz.

### Example

```
:SENSe1:FREQuency:STOP 10000000 /*Sets the stop frequency to 10 MHz.*/
:SENSe1:FREQuency:STOP? /*The query returns 1.00e+07.*/
```

## 6.1.3 :SENSe<cn>:FREQuency:CENTer

### Syntax

```
:SENSe<cn>:FREQuency:CENTer <freq>
```

```
:SENSe<cn>:FREQuency:CENTer?
```

### Description

Sets the center frequency for the specified channel.

Queries the center frequency for the specified channel.

**Parameter**

Name	Type	Range	Default
<cn>	Integer	1 to 500	1
<freq>	Real	Refer to Remarks	-

**Remarks**

Center frequency is the middle value between the stop frequency (:SENSe<cn>:FREQUENCY:STOP) and the start frequency (:SENSe<cn>:FREQUENCY:START). Modifying the center frequency will affect the start frequency and stop frequency.

**Return Format**

The query returns the center frequency in scientific notation. The unit is Hz.

**Example**

```
:SENSe1:FREQUENCY:CENTer 50000000 /*Sets the center frequency to 50 MHz.*/
:SENSe1:FREQUENCY:CENTer? /*The query returns 5.00e+07.*/
```

**6.1.4 :SENSe<cn>:FREQUENCY:SPAN****Syntax**

```
:SENSe<cn>:FREQUENCY:SPAN <span>
```

```
:SENSe<cn>:FREQUENCY:SPAN?
```

**Description**

Sets the frequency span of the specified channel.

Queries the frequency span of the specified channel.

**Parameter**

Name	Type	Range	Default
<cn>	Integer	1 to 500	1
<freq>	Real	Refer to Remarks	-

**Remarks**

Frequency span is the difference between the stop frequency (:SENSe<cn>:FREQUENCY:STOP) and the start frequency (:SENSe<cn>:FREQUENCY:START). Modifying the frequency span will affect the start frequency and stop frequency.

**Return Format**

The query returns the frequency span in scientific notation. The unit is Hz.

**Example**

```
:SENSe1:FREQuency:SPAN 100000 /*Sets the frequency span to 100 kHz.*/
:SENSe1:FREQuency:SPAN? /*The query returns 1.00e+05.*/
```

**6.1.5 :SENSe<cn>:FREQuency:CW****Syntax**

```
:SENSe<cn>:FREQuency:CW <freq>
```

```
:SENSe<cn>:FREQuency:CW?
```

**Description**

Sets the CW frequency for the specified channel.

Queries the CW frequency for the specified channel.

**Parameter**

Name	Type	Range	Default
<cn>	Integer	1 to 500	1
<freq>	Real	Refer to Remarks	1 GHz

**Remarks**

This command is valid when the sweep type is set to Power (:SENSe<cn>:SWEep:TYPE).

The range of the <freq> parameter is related to the product model. For the product model, refer to product model table.

**Return Format**

The query returns the CW frequency in scientific notation. The unit is Hz.

**Example**

```
:SENSe1:FREQuency:CW 50000000 /*Sets the CW frequency to 50 MHz.*/
:SENSe1:FREQuency:CW? /*The query returns 5.00e+07.*/
```

**6.1.6 :SENSe<cn>:FREQuency:FIXed****Syntax**

```
:SENSe<cn>:FREQuency:FIXed <freq>
```

```
:SENSe<cn>:FREQuency:FIXed?
```

**Description**

Sets the CW frequency for the specified channel.

Queries the CW frequency for the specified channel.

**Parameter**

Name	Type	Range	Default
<cn>	Integer	1 to 500	1
<freq>	Real	Refer to Remarks	1 GHz

**Remarks**

This command has the same function as the `:SENSe<cn>:FREQUENCY:CW` command.

**Return Format**

The query returns the CW frequency in scientific notation. The unit is Hz.

**Example**

```
:SENSe1:FREQUENCY:FIXed 50000000 /*Sets the CW frequency to 50
MHz.*/
:SENSe1:FREQUENCY:FIXed? /*The query returns 5.00e+07.*/
```

**6.1.7 :SENSe<cn>:FREQUENCY:DATA?****Syntax**

```
:SENSe<CN>:FREQUENCY:DATA?
```

**Description**

Queries the frequency list of the specified channel.

**Parameter**

Name	Type	Range	Default
<cn>	Integer	1 to 500	1

**Remarks**

N/A

**Return Format**

The query returns the frequency list in strings, separated by commas.

**Example**

```
:SENSe1:FREQUENCY:DATA? /*The query returns +1.000000000000E
+07,+1.424500000000E+08,...*/
```

## 6.2 :SENSe<cn>:SWEep Commands

The :SENSe<cn>:SWEep commands are used to set and query the sweep parameters.

### 6.2.1 :SENSe<cn>:SWEep:STEP

#### Syntax

```
:SENSe<cn>:SWEep:STEP?
```

#### Description

Queries the frequency step of the specified channel.

#### Parameter

Name	Type	Range	Default
<cn>	Integer	1 to 500	1

#### Remarks

This command is valid when the sweep type (:SENSe<cn>:SWEep:TYPE) is set to Linear.

#### Return Format

The query returns the frequency step of the specified channel in scientific notation. The unit is Hz.

#### Example

```
:SENSe1:SWEep:STEP? /*The query returns 1.00e+07.*/
```

### 6.2.2 :SENSe<cn>:SWEep:POINTs

#### Syntax

```
:SENSe<cn>:SWEep:POINTs <num>
```

```
:SENSe<cn>:SWEep:POINTs?
```

#### Description

Sets the number of sweep points for the specified channel.

Queries the number of sweep points for the specified channel.

#### Parameter

Name	Type	Range	Default
<cn>	Integer	1 to 500	1

Name	Type	Range	Default
<num>	Integer	1 to 100001	201

**Remarks**

Increasing the sweep points cause the sweep time (:SENSe<cn>:SWEep:TIME:AUTO) to increase.

**Return Format**

The query returns the number of sweep points in integer.

**Example**

```
:SENSe1:SWEep:POINTs 1000 /*Sets the number of sweep points for
Channel 1 to 1000.*/
:SENSe1:SWEep:POINTs? /*The query returns 1000.*/
```

### 6.2.3 :SENSe<cn>:SWEep:TYPE

**Syntax**

```
:SENSe<cn>:SWEep:TYPE <type>
```

```
:SENSe<cn>:SWEep:TYPE?
```

**Description**

Sets the sweep type for the specified channel.

Queries the sweep type for the specified channel.

**Parameter**

Name	Type	Range	Default
<cn>	Integer	1 to 500	1
<type>	Discrete	{LINear LOGarithmic POWer SEGMENT}	LINear

**Remarks**

LINear: linear frequency sweep. LOGarithmic: Log frequency sweep. POWer: power sweep. SEGMENT: segment sweep.

**Return Format**

The query returns LIN, LOG, POW, or SEGM.

**Example**

```
:SENSe1:SWEep:TYPE LOGarithmic /*Sets the sweep type to
LOGarithmic.*/
:SENSe1:SWEep:TYPE? /*The query returns LOG.*/
```

## 6.2.4 :SENSe<cn>:SWEep:TIME:AUTO

### Syntax

```
:SENSe<cn>:SWEep:TIME:AUTO <bool>
```

```
:SENSe<cn>:SWEep:TIME:AUTO?
```

### Description

Sets whether to enable auto sweep time for the specified channel.

Queries whether to enable auto sweep time for the specified channel.

### Parameter

Name	Type	Range	Default
<cn>	Integer	1 to 500	1
<bool>	Bool	{{1 ON}}{0 OFF}}	1 ON

### Remarks

When <bool> is set to ON, auto sweep time is selected. When <bool> is set to OFF, manual sweep time is selected.

### Return Format

The query returns 0 or 1.

### Example

```
:SENSe1:SWEep:TIME:AUTO ON /*Enables auto sweep time for Channel 1.*/
:SENSe1:SWEep:TIME:AUTO? /*The query returns 1.*/
```

## 6.2.5 :SENSe<cn>:SWEep:TIME[:STOP]

### Syntax

```
:SENSe<cn>:SWEep:TIME[:STOP] <value>
```

```
:SENSe<cn>:SWEep:TIME[:STOP]?
```

### Description

Sets the sweep time for the analyzer to take to complete one sweep for the specified channel.

Queries the sweep time for the analyzer to take to complete one sweep for the specified channel.

**Parameter**

Name	Type	Range	Default
<cn>	Integer	1 to 500	1
<value>	Real	Refer to Remarks	-

**Remarks**

Running this command can set the sweep time. After completing executing this command, the auto sweep time function (:SENSe<cn>:SWEep:TIME:AUTO) is disabled and switches to manual sweep time setting.

The range of <value> varies with the sweep points (:SENSe<cn>:SWEep:POINTS), IF bandwidth (:SENSe<cn>:BANDwidth[:RESolution]), and dwell time (:SENSe<cn>:SWEep:DWEL).

**Return Format**

The query returns the sweep time in scientific notation. The unit is s.

**Example**

```
:SENSe1:SWEep:TIME 1 /*Sets the sweep time for Channel 1 to 1 s.*/
:SENSe1:SWEep:TIME? /*The query returns 1.00e+00.*/
```

**6.2.6 :SENSe<cn>:SWEep:GENERation:POINTsweep****Syntax**

```
:SENSe<cn>:SWEep:GENERation:POINTsweep <bool>
```

```
:SENSe<cn>:SWEep:GENERation:POINTsweep?
```

**Description**

Enables the point sweep sequence for the specified channel.

Queries whether the point sweep sequence for the specified channel is enabled.

**Parameter**

Name	Type	Range	Default
<cn>	Integer	1 to 500	1
<bool>	Bool	{{1 ON}}{0 OFF}}	0 OFF

**Remarks**

- OFF: If it is set to OFF, the point sweep sequence is disabled. It is standard sweep (STD). The analyzer sweeps all data points for each source port in sequence. First all the data points of Port1, then Port2....
- ON: enables the Point sweep sequence. The analyzer measures all S-parameters at each frequency point before stepping to the next frequency.

**Return Format**

The query returns 0 or 1.

**Example**

```
:SENSe1:SWEep:GENeration:POINTsweep ON /*Enables the point sweep
sequence.*/
:SENSe1:SWEep:GENeration:POINTsweep? /*The query returns 1.*/
```

**6.2.7 :SENSe<cn>:SWEep:DWELI****Syntax**

```
:SENSe<cn>:SWEep:DWELI <value>
```

```
:SENSe<cn>:SWEep:DWELI?
```

**Description**

Sets the dwell time between each sweep point for the specified channel.

Queries the dwell time between each sweep point for the specified channel.

**Parameter**

Name	Type	Range	Default
<cn>	Integer	1 to 500	1
<value>	Real	0 to 20 s	0

**Remarks**

N/A

**Return Format**

The query returns the dwell time between each sweep point in scientific notation. The unit is s.

**Example**

```
:SENSe1:SWEep:DWELl 0.0001 /*Sets the dwell time between each sweep
point of Channel 1 to 0.1 ms.*/
:SENSe1:SWEep:DWELl? /*The query returns 1.00e-04.*/
```

**6.2.8 :SENSe<cn>:SWEep:DWELl:SDELay****Syntax**

```
:SENSe<cn>:SWEep:DWELl:SDELay <value>
```

```
:SENSe<cn>:SWEep:DWELl:SDELay?
```

**Description**

Sets the delay time for the specified channel.

Queries the delay time for the specified channel.

**Parameter**

Name	Type	Range	Default
<cn>	Integer	1 to 500	1
<value>	Real	0 to 20 s	0

**Remarks**

The delay configured by this command does not include the dwell time (:SENSe<cn>:SWEep:DWELl).

**Return Format**

The query returns the delay time in scientific notation. The unit is s.

**Example**

```
:SENSe1:SWEep:DWELl:SDELay 0.0001 /*Sets the delay time for Channel
1 to 0.1 ms.*/
:SENSe1:SWEep:DWELl:SDELay? /*The query returns 1.00e-04.*/
```

**6.2.9 :SENSe<cn>:SWEep:GROups:COUNT****Syntax**

```
:SENSe<cn>:SWEep:GROups:COUNT <num>
```

```
:SENSe<cn>:SWEep:GROups:COUNT?
```

**Description**

Sets the number of trigger times for Groups trigger for the specified channel.

Queries the number of trigger times for Groups trigger for the specified channel.

**Parameter**

Name	Type	Range	Default
<cn>	Integer	1 to 500	1
<num>	Integer	1 to 2000000	1

**Remarks**

This command is valid when the trigger state (*:SENSe<cn>:SWEep:MODE*) is set to GROUps.

**Return Format**

The query returns an integer.

**Example**

```
:SENSe1:SWEep:GROUps:COUNT 10 /*Sets the number of trigger times
for Groups trigger of Channel 1 to 10.*/
:SENSe1:SWEep:GROUps:COUNT? /*The query returns 10.*/
```

## 6.2.10 :SENSe<cn>:SWEep:MODE

**Syntax**

*:SENSe<cn>:SWEep:MODE <type>*

*:SENSe<cn>:SWEep:MODE?*

**Description**

Sets the trigger state of the specified channel.

Queries the trigger state of the specified channel.

**Parameter**

Name	Type	Range	Default
<cn>	Integer	1 to 500	1
<type>	Discrete	{HOLD CONTInuous GROUps SINGLE}	CONT

**Remarks**

- **HOLD:** the channel will not trigger.
- **CONTInuous:** the channel triggers indefinitely and continuously.
- **GROUps:** the channel receives a number of triggers specified by the *:SENSe<cn>:SWEep:GROUps:COUNT* command.
- **SINGLE:** the channel receives one trigger, then goes to Hold state.

**Return Format**

The query returns HOLD, CONT, GRO, or SING.

**Example**

```
:SENSe1:SWEep:MODE SINGLE /*Sets the trigger state to SINGLE.*/
:SENSe1:SWEep:MODE? /*The query returns SING.*/
```

**6.2.11 :SENSe<cn>:SWEep:TRIGger:MODE****Syntax**

```
:SENSe<cn>:SWEep:TRIGger:MODE <type>
```

```
:SENSe<cn>:SWEep:TRIGger:MODE?
```

**Description**

Sets the trigger modes of the specified channel.

Queries the trigger modes of the specified channel.

**Parameter**

Name	Type	Range	Default
<cn>	Integer	1 to 500	1
<type>	Discrete	{CHANnel SWEep POINt}	CHANnel

**Remarks**

- **CHANnel:** Each trigger causes all the traces in the channel to be swept.
- **SWEep:** Each manual or external trigger signal (:TRIGger[:SEQuence]:SOURce) causes all traces that share a source port to be swept.
- **POINt:** Each Manual or External trigger signal causes one data point to be measured.

**Return Format**

The query returns CHAN, SWE, or POIN.

**Example**

```
:SENSe1:SWEep:TRIGger:MODE SWEep /*Sets the trigger mode to SWEep.*/
:SENSe1:SWEep:TRIGger:MODE? /*The query returns SWE.*/
```

## 6.3 :SENSe<cn>:BANDwidth Commands

The :SENSe<cn>:BANDwidth commands are used to set and query the IF Bandwidth related parameters.

### 6.3.1 :SENSe<cn>:BANDwidth[:RESolution]

#### Syntax

```
:SENSe<cn>:BANDwidth[:RESolution] <freq>
```

```
:SENSe<cn>:BANDwidth[:RESolution]?
```

#### Description

Sets the IF bandwidth for the specified channel.

Queries the IF bandwidth for the specified channel.

#### Parameter

Name	Type	Range	Default
<cn>	Integer	1 to 500	1
<freq>	Real	1 Hz to 10 MHz	100 kHz

#### Remarks

N/A

#### Return Format

The query returns the IF bandwidth for the specified channel in scientific notation. The unit is Hz.

#### Example

```
:SENSe1:BANDwidth 100 /*Sets the IF bandwidth for Channel 1 to 100 Hz.*/
:SENSe1:BANDwidth? /*The query returns 1.00e+02.*/
```

### 6.3.2 :SENSe<cn>:BWIDth[:RESolution]

#### Syntax

```
:SENSe<cn>:BWIDth[:RESolution] <freq>
```

```
:SENSe<cn>:BWIDth[:RESolution]?
```

#### Description

Sets the IF bandwidth for the specified channel.

Queries the IF bandwidth for the specified channel.

**Parameter**

Name	Type	Range	Default
<cn>	Integer	1 to 500	1
<freq>	Real	1 Hz to 10 MHz	100 kHz

**Remarks**

This command has the same function as the *:SENSe<cn>:BANDwidth[:RESolution]* command.

**Return Format**

The query returns the IF bandwidth for the specified channel in scientific notation. The unit is Hz.

**Example**

```
:SENSe1:BWIDth 100 /*Sets the IF bandwidth for Channel 1 to 100 Hz.*/
:SENSe1:BWIDth? /*The query returns 1.00e+02.*/
```

## 6.4 :SENSe<cn>:SEGMENT Commands

The :SENSe<cn>:SEGMENT commands are used to set and query the Segment Sweep related parameters.

### 6.4.1 :SENSe<cn>:SEGMENT:DELEte:ALL

**Syntax**

```
:SENSe<cn>:SEGMENT:DELEte:ALL
```

**Description**

Delete all segments from the segment table for the specified channel.

**Parameter**

Name	Type	Range	Default
<cn>	Integer	1 to 500	1

**Remarks**

After completing executing this command, the *:SENSe<cn>:SWEep:TYPE* command is automatically set to LINear.

**Return Format**

N/A

**Example**

N/A

**6.4.2 :SENSe<cn>:SEGMent:SWEEp:DWELL:CONTROL****Syntax**`:SENSe<cn>:SEGMent:SWEEp:DWELL:CONTROL <bool>``:SENSe<cn>:SEGMent:SWEEp:DWELL:CONTROL?`**Description**

Enables or disables the dwell time for each sweep segment.

Queries whether to enable the dwell time for each sweep segment.

**Parameter**

Name	Type	Range	Default
<cn>	Integer	1 to 500	1
<bool>	Bool	{{1 ON}}{0 OFF}}	0 OFF

**Remarks**

When <bool> is set to OFF or 0, you can run the `:SENSe<cn>:SWEEp:DWELL:SDElay` command to set the dwell time for the specified channel.

**Return Format**

The query returns 1 or 0.

**Example**

```
:SENSe1:SEGMent:SWEEp:DWELL:CONTROL ON /*Enables the dwell time for
each sweep segment of Channel 1.*/
:SENSe1:SEGMent:SWEEp:DWELL:CONTROL? /*The query returns 1.*/
```

**6.4.3 :SENSe<cn>:SEGMent:SWEEp:TIME:CONTROL****Syntax**`:SENSe<cn>:SEGMent:SWEEp:TIME:CONTROL <bool>``:SENSe<cn>:SEGMent:SWEEp:TIME:CONTROL?`**Description**

Enables or disables the sweep time for each sweep segment.

Queries whether to enable the sweep time for each sweep segment.

**Parameter**

Name	Type	Range	Default
<cn>	Integer	1 to 500	1
<bool>	Bool	{{1 ON}}{0 OFF}}	1 ON

**Remarks**

If <bool> is set to OFF or 0, the sweep time will not be set each segment. You can run the `:SENSe<cn>:SWEep:TIME[:STOP]` command to set the sweep time for the specified channel.

**Return Format**

The query returns 1 or 0.

**Example**

```
:SENSe1:SEGMENT:SWEep:TIME:CONTROL ON /*Enables the sweep time for
each sweep segment of Channel 1.*/
:SENSe1:SEGMENT:SWEep:TIME:CONTROL? /*The query returns 1.*/
```

## 6.4.4 :SENSe<cn>:SEGMENT:SWEep:DeLay:CONTROL

**Syntax**

```
:SENSe<cn>:SEGMENT:SWEep:DeLay:CONTROL <bool>
```

```
:SENSe<cn>:SEGMENT:SWEep:DeLay:CONTROL?
```

**Description**

Enables or disables the delay time for each sweep segment.

Queries whether to enable the delay time for each sweep segment.

**Parameter**

Name	Type	Range	Default
<cn>	Integer	1 to 500	1
<bool>	Bool	{{1 ON}}{0 OFF}}	0 OFF

**Remarks**

If you set <bool> to ON or 1, then you can run the `:SENSe<cn>:SWEep:DWELL:SDElay` command to set the delay time for the specified channel.

**Return Format**

The query returns 1 or 0.

**Example**

```
:SENSe1:SEGMENT:SWEep:DeLay:CONTRol ON /*Enables the delay time for
each sweep segment for Channel 1.*/
:SENSe1:SEGMENT:SWEep:DeLay:CONTRol? /*The query returns 1.*/
```

**6.4.5 :SENSe<cn>:SEGMENT:BWIDth[:RESolution] :CONTRol****Syntax**

```
:SENSe<cn>:SEGMENT:BWIDth[:RESolution]:CONTRol <bool>
:SENSe<cn>:SEGMENT:BWIDth[:RESolution]:CONTRol?
```

**Description**

Sets whether to set IF bandwidth for each sweep segment.

Queries whether to set IF bandwidth for each sweep segment.

**Parameter**

Name	Type	Range	Default
<cn>	Integer	1 to 500	1
<bool>	Bool	{{1 ON}} {{0 OFF}}	0 OFF

**Remarks**

- ON (or 1): enables to set IF bandwidth for each sweep segment.
- OFF (or 0): disables setting the IF bandwidth for each sweep segment. To set the IF bandwidth, run the `:SENSe<cn>:BANDwidth[:RESolution]` command.

**Return Format**

The query returns 1 or 0.

**Example**

```
:SENSe1:SEGMENT:BWIDth:CONTRol ON /*Enables to set the IF bandwidth
independently for each sweep segment for Channel 1.*/
:SENSe1:SEGMENT:BWIDth:CONTRol? /*The query returns 1.*/
```

**6.4.6 :SENSe<cn>:SEGMENT:BWIDth:PORT[:RESolution]:CONTRol****Syntax**

```
:SENSe<cn>:SEGMENTBWIDth:PORT[:RESolution]:CONTRol <bool>
:SENSe<cn>:SEGMENTBWIDth:PORT[:RESolution]:CONTRol?
```

**Description**

Sets whether to set IF bandwidth for each port of the each sweep segment.

Queries whether to set IF bandwidth for each port of the each sweep segment.

#### Parameter

Name	Type	Range	Default
<cn>	Integer	1 to 500	1
<bool>	Bool	{{1 ON}}{0 OFF}}	0 OFF

#### Remarks

When <bool> is set to ON or 1, it indicates that you can set IF bandwidth for each port independently. When <bool> is set to OFF or 0, you are not allowed to set the IF bandwidth for each port independently.

#### Return Format

The query returns 1 or 0.

#### Example

```
:SENSe1:SEGMENT:BWIDth:PORT1:CONTRol ON /*Enables setting the IF
bandwidth independently for Port 1 in the segment sweep for Channel
1.*/
:SENSe1:SEGMENT:BWIDth:PORT1:CONTRol? /*The query returns 1.*/
```

## 6.4.7 :SENSe<cn>:SEGMENT:POWER[:LEVEL]:CONTROL

#### Syntax

```
:SENSe<cn>:SEGMENT:POWER[:LEVEL]:CONTROL <bool>
```

```
:SENSe<cn>:SEGMENT:POWER[:LEVEL]:CONTROL?
```

#### Description

Enables or disables setting power level for each sweep segment.

Queries whether to set power level for each sweep segment.

#### Parameter

Name	Type	Range	Default
<cn>	Integer	1 to 500	1
<bool>	Bool	{{1 ON}}{0 OFF}}	1 ON

#### Remarks

- ON (or 1): enables setting power level for each sweep segment.

- OFF (or 0): disables setting power level for each sweep segment. You can run the `:SOURce<cn>:POWer<pn>[:LEVel][:IMMEdiate][:AMPLitude]` command to set the power level.

#### Return Format

The query returns 1 or 0.

#### Example

```
:SENSe1:SEGMENT:POWer:CONTRol ON /*Enables setting power level for
the segment sweep for Channel 1.*/
:SENSe1:SEGMENT:POWer:CONTRol? /*The query returns 1.*/
```

## 6.4.8 :SENSe<cn>:SEGMENT<sgn>:ADD

#### Syntax

```
:SENSe<cn>:SEGMENT<sgn>:ADD
```

#### Description

Adds a segment with the specified ID for the specified channel.

#### Parameter

Name	Type	Range	Default
<cn>	Integer	1 to 500	1
<sgn>	Integer	1 to 32	1

#### Remarks

Segment numbers must be sequential. If a new number is added where one currently exists, the existing segment and those following are incremented by one.

#### Return Format

N/A

#### Example

N/A

## 6.4.9 :SENSe<cn>:SEGMENT<sgn>:DELEte

#### Syntax

```
:SENSe<cn>:SEGMENT<sgn>:DELEte
```

#### Description

Deletes the specified segments from the segment table for the specified channel.

**Parameter**

Name	Type	Range	Default
<cn>	Integer	1 to 500	1
<sgn>	Integer	1 to 32	1

**Remarks**

After running this command to delete the specified segment, the remaining sweep segments will be numbered automatically in sequence.

After completing executing this command, the *:SENSe<cn>:SWEep:TYPE* command is automatically set to LINear.

**Return Format**

N/A

**Example**

N/A

## 6.4.10 :SENSe<cn>:SEGMENT<sgn>[:STATe]

**Syntax**

```
:SENSe<cn>:SEGMENT<sgn>[:STATe] <bool>
```

```
:SENSe<cn>:SEGMENT<sgn>[:STATe]?
```

**Description**

Enables or disables the specified sweep segment for the specified channel.

Queries the on/off status of the specified sweep segment for the specified channel.

**Parameter**

Name	Type	Range	Default
<cn>	Integer	1 to 500	1
<sgn>	Integer	1 to 32	1
<bool>	Bool	{{1 ON}}{0 OFF}}	0 OFF

**Remarks**

N/A

**Return Format**

The query returns 1 or 0.

**Example**

```
:SENSe1:SEGMENT1 ON /*Enables Segment 1 for Channel 1.*/  
:SENSe1:SEGMENT1? /*The query returns 1.*/*
```

**6.4.11 :SENSe<cn>:SEGMENT<sgn>:FREQUENCY:START****Syntax**

```
:SENSe<cn>:SEGMENT<sgn>:FREQUENCY:START <freq>
```

```
:SENSe<cn>:SEGMENT<sgn>:FREQUENCY:START?
```

**Description**

Sets the start frequency of the specified sweep segment for the specified channel.

Queries the start frequency of the specified sweep segment for the specified channel.

**Parameter**

Name	Type	Range	Default
<cn>	Integer	1 to 500	1
<sgn>	Integer	1 to 32	1
<freq>	Real	Refer to Remarks	10 MHz

**Remarks**

The range of the <freq> parameter is related to the product model. For the product model, refer to product model table.

After running this command, the start frequency and stop frequency of other segments that are greater than the set value will be modified to this start frequency value.

**Return Format**

The query returns the start frequency of the specified segment in scientific notation. The unit is Hz.

**Example**

```
:SENSe1:SEGMENT1:FREQUENCY:START 10000000 /*Sets the start  
frequency of Segment 1 for Channel 1 to 10 MHz.*/  
:SENSe1:SEGMENT1:FREQUENCY:START? /*The query returns 1.00e+07.*/*
```

**6.4.12 :SENSe<cn>:SEGMENT<sgn>:FREQUENCY:STOP****Syntax**

```
:SENSe<cn>:SEGMENT<sgn>:FREQUENCY:STOP <freq>
```

```
:SENSe<cn>:SEGMENT<sgn>:FREQUENCY:STOP?
```

**Description**

Sets the stop frequency of the specified sweep segment for the specified channel.

Queries the stop frequency of the specified sweep segment for the specified channel.

**Parameter**

Name	Type	Range	Default
<cn>	Integer	1 to 500	1
<sgn>	Integer	1 to 32	1
<freq>	Real	Refer to Remarks	1 GHz

**Remarks**

After running this command, the start frequency and stop frequency of other segments that are greater than the set value will be modified to this stop frequency value.

The range of the <freq> parameter is related to the product model. For the product model, refer to product model table.

**Return Format**

The query returns the stop frequency of the specified segment in scientific notation. The unit is Hz.

**Example**

```
:SENSe1:SEGMENT1:FREQUENCY:STOP 10000000 /*Sets the stop frequency
of the Segment 1 for Channel 1 to 10 MHz.*/
:SENSe1:SEGMENT1:FREQUENCY:STOP? /*The query returns 1.00e+07.*/
```

**6.4.13 :SENSe<cn>:SEGMENT<sgn>:SWEep:POINTs****Syntax**

```
:SENSe<cn>:SEGMENT<sgn>:SWEep:POINTs <num>
```

```
:SENSe<cn>:SEGMENT<sgn>:SWEep:POINTs?
```

**Description**

Sets the number of sweep points for the specified sweep segment for the specified channel.

Queries the number of sweep points for the specified sweep segment for the specified channel.

**Parameter**

Name	Type	Range	Default
<cn>	Integer	1 to 500	1
<sgn>	Integer	1 to 32	1
<num>	Integer	1 to 100001	21

**Remarks**

N/A

**Return Format**

The query returns the number of sweep points in integer.

**Example**

```
:SENSe1:SEGMENT1:SWEep:POINTs 1000 /*Sets the number of sweep
points for Segment 1 of Channel 1 to 1000.*/
:SENSe1:SEGMENT1:SWEep:POINTs? /*The query returns 1000.*/
```

## 6.4.14 :SENSe<cn>:SEGMENT<sgn>:SWEep:TIME

**Syntax**

```
:SENSe<cn>:SEGMENT<sgn>:SWEep:TIME <value>
```

```
:SENSe<cn>:SEGMENT<sgn>:SWEep:TIME?
```

**Description**

Sets the sweep time for the specified sweep segment for the specified channel.

Queries the sweep time for the specified sweep segment for the specified channel.

**Parameter**

Name	Type	Range	Default
<cn>	Integer	Refer to Remarks	1
<sgn>	Integer	1 to 32	1
<value>	Real	Refer to Remarks	-

**Remarks**

Before performing this command, first set the *:SENSe<cn>:SEGMENT:SWEep:TIME:CONTROL* command to ON.

The range of <value> and its default value are determined by the sweep points, IF bandwidth, and sweep dwell time.

**Return Format**

The query returns the sweep time for the segment sweep in scientific notation. The unit is s.

**Example**

```
:SENSe1:SEGMENT1:SWEep:TIME 1 /*Sets the sweep time for Segment 1
of Channel 1 to 1 s.*/
:SENSe1:SEGMENT1:SWEep:TIME? /*The query returns 1.000000000000000e
+00.*/
```

**6.4.15 :SENSe<cn>:SEGMENT<sgn>:SWEep:DWELL****Syntax**

```
:SENSe<cn>:SEGMENT<sgn>:SWEep:DWELL <value>
```

```
:SENSe<cn>:SEGMENT<sgn>:SWEep:DWELL?
```

**Description**

Sets the dwell time for the specified sweep segment for the specified channel.

Queries the dwell time for the specified sweep segment for the specified channel.

**Parameter**

Name	Type	Range	Default
<cn>	Integer	1 to 500	1
<sgn>	Integer	1 to 32	1
<value>	Real	0 s to 20 s	0

**Remarks**

Before performing this command, first set the *:SENSe<cn>:SEGMENT:SWEep:DWELL:CONTROL* command to ON.

**Return Format**

The query returns the dwell time for the specified sweep segment in scientific notation. The unit is s.

**Example**

```
:SENSe1:SEGMENT1:SWEep:DWELL 0.0001 /*Sets the dwell time for
Segment 1 of Channel 1 to 0.1 ms.*/
:SENSe1:SEGMENT1:SWEep:DWELL? /*The query returns 1.00e-04.*/
```

## 6.4.16 :SENSe<cn>:SEGMent<sgn>:SWEep:DELay

### Syntax

```
:SENSe<cn>:SEGMent<sgn>:SWEep:DELay <value>
:SENSe<cn>:SEGMent<sgn>:SWEep:DELay?
```

### Description

Sets the delay time for the specified sweep segment for the specified channel.

Queries the delay time for the specified sweep segment for the specified channel.

### Parameter

Name	Type	Range	Default
<cn>	Integer	1 to 500	1
<sgn>	Integer	1 to 32	1
<value>	Real	0 to 20 s	0

### Remarks

Before performing this command, set the *:SENSe<cn>:SEGMent:SWEep:DeLay:CONTRol* command to ON.

### Return Format

The query returns the delay time for the segment sweep in scientific notation. The unit is s.

### Example

```
:SENSe1:SEGMent1:SWEep:DELay 0.1 /*Sets the delay time for Segment
1 of Channel 1 to 0.1 ms.*/
:SENSe1:SEGMent1:SWEep:DELay? /*The query returns 1.00e-04.*/
```

## 6.4.17 :SENSe<cn>:SEGMent<sgn>:BWIDth[:RESolution]

### Syntax

```
:SENSe<cn>:SEGMent<sgn>:BWIDth[:RESolution] <freq>
:SENSe<cn>:SEGMent<sgn>:BWIDth[:RESolution]?
```

### Description

Sets the IF bandwidth for the specified sweep segment of the specified channel.

Queries the IF bandwidth for the specified sweep segment of the specified channel.

**Parameter**

Name	Type	Range	Default
<cn>	Integer	1 to 500	1
<sgn>	Integer	1 to 32	1
<freq>	Real	1 Hz to 10 MHz	100 kHz

**Remarks**

Before performing this command, first set the *:SENSe<cn>:SEGMENT:BWIDth[:RESolution]:CONTrol* command to ON.

**Return Format**

The query returns the IF bandwidth for the specified channel. The unit is Hz.

**Example**

```
:SENSe1:SEGMENT1:BWIDth 100 /*Sets the IF bandwidth of Segment1 for
Channel 1 to 100 Hz.*/
:SENSe1:SEGMENT1:BWIDth? /*The query returns 1.000000000000000e
+02.*/
```

## 6.4.18 :SENSe<cn>:SEGMENT<sgn>:BWIDth:PORT<pn>[:RESolution]

**Syntax**

```
:SENSe<cn>:SEGMENT<sgn>:BWIDth:PORT<pn>[:RESolution] <freq>
```

```
:SENSe<cn>:SEGMENT<sgn>:BWIDth:PORT<pn>[:RESolution]?
```

**Description**

Sets the IF bandwidth on the specified port of the specified segment for the specified channel.

Queries the IF bandwidth on the specified port of the specified segment for the specified channel.

**Parameter**

Name	Type	Range	Default
<cn>	Integer	1 to 500	1
<sgn>	Integer	1 to 32	1
<pn>	Integer	Refer to Remarks	1
<freq>	Real	1 Hz to 10 MHz	100 kHz

**Remarks**

- For DNA6082-R, DNA6142-R, DNA6202-R, and DNA6262-R, <pn> can be set to 1 or 2.
- For DNA6084-R, DNA6144-R, DNA6204-R, and DNA6264-R, <pn> can be set to 1, 2, 3, or 4.
- Before performing this command, first set the `:SENSe<cn>:SEGMENT:BWIDth:PORT[:RESolution]:CONTRol` command to ON.

**Return Format**

The query returns the IF bandwidth on the specified port of the specified segment for the specified channel in scientific notation. The unit is Hz.

**Example**

```
:SENSe1:SEGMENT1:BWIDth:PORT1 10 /*Sets the IF bandwidth on Port 1
of Segment1 for Channel 1 to 10 Hz.*/
:SENSe1:SEGMENT1:BWIDth:PORT1? /*The query returns 1.00e+01.*/
```

## 6.4.19 :SENSe<cn>:SEGMENT<sgn>:POWER[<pn>][:LEVEL]

**Syntax**

```
:SENSe<cn>:SEGMENT<sgn>:POWER[<pn>][:LEVEL] <value>
```

```
:SENSe<cn>:SEGMENT<sgn>:POWER[<pn>][:LEVEL]?
```

**Description**

Sets the power on the specified port of the specified sweep segment for the specified channel.

Queries the power on the specified port of the specified sweep segment for the specified channel.

**Parameter**

Name	Type	Range	Default
<cn>	Integer	1 to 500	1
<sgn>	Integer	1 to 32	1
<pn>	Integer	Refer to Remarks	1
<value>	Real	-40 dBm to 15 dBm	-5 dBm

**Remarks**

Before performing this command, set the `:SENSe<cn>:SEGMENT:POWer[:LEVel]:CONTRol` command to ON.

This command is valid when the sweep type (`:SENSe<cn>:SWEep:TYPE`) is set to SEGMENT.

- For DNA6082-R, DNA6142-R, DNA6202-R, and DNA6262-R, <pn> can be set to 1 or 2.
- For DNA6084-R, DNA6144-R, DNA6204-R, and DNA6264-R, <pn> can be set to 1, 2, 3, or 4.

**Return Format**

The query returns the port power in scientific notation. The unit is dBm.

**Example**

```
:SENSe1:SEGMENT1:POWer 10 /*Sets the power on Port 1 of Segment 1
for Channel 1 to 10 dBm.*/
:SENSe1:SEGMENT1:POWer? /*The query returns 1.00e+01.*/
```

## 6.5 :SENSe<cn>:CORRection Commands

The `:SENSe<cn>:CORRection` commands are used to set and query the calibration related parameters.

### 6.5.1 :SENSe<cn>:CORRection[:STATE]

**Syntax**

```
:SENSe<cn>:CORRection[:STATE] <bool>
```

```
:SENSe<cn>:CORRection[:STATE]?
```

**Description**

Enables or disables the correction for the specified channel.

Queries the on/off status of correction for the specified channel.

**Parameter**

Name	Type	Range	Default
<cn>	Integer	1 to 500	1
<bool>	Bool	{{1 ON}}{0 OFF}}	0 OFF

**Remarks**

Before calibration, run the `:CALCulate<cn>:MEASure<mn>:PARAmeter` command to select the measurement item first.

After completing the calibration or loading the calibration files successfully, correction is performed automatically, and its state turns out to be ON. If the instrument is not calibrated, correction cannot be enabled.

**Return Format**

The query returns 1 or 0.

**Example**

```
:SENSe1:CORRection ON /*Enables the correction for Channel 1.*/
:SENSe1:CORRection? /*The query returns 1.*/
```

## 6.5.2 :SENSe<cn>:CORRection:RVELOCITY:COAX

**Syntax**

```
:SENSe<cn>:CORRection:RVELOCITY:COAX <value>
```

```
:SENSe<cn>:CORRection:RVELOCITY:COAX?
```

**Description**

Sets the velocity factor for electrical delay.

Queries the velocity factor for electrical delay.

**Parameter**

Name	Type	Range	Default
<cn>	Integer	1 to 500	1
<value>	Real	0 to 1	0.66

**Remarks**

- This command will also change the velocity factor in DTF and TDA. To set or query the velocity factor in DTF and TDA, run the `:CALCulate<cn>:MEASure<mn>:TRANSform:DTFault:VELOCITY` command.
- This command takes effects on velocity factor for all the channels and ports.

**Return Format**

The query returns the velocity factor in scientific notation.

**Example**

```
:SENSe1:CORRection:RVELOCITY:COAX 0.7 /*Sets the velocity factor
for electrical delay to 0.7.*/
:SENSe1:CORRection:RVELOCITY:COAX? /*The query returns 7.00e-01.*/
```

**6.5.3 :SENSe<cn>:CORRection:INTerpolate[:STATe]****Syntax**

```
:SENSe<cn>:CORRection:INTerpolate[:STATe] <bool>
```

```
:SENSe<cn>:CORRection:INTerpolate[:STATe]?
```

**Description**

Enables or disables the interpolation for the specified channel.

Queries the on/off status of interpolation for the specified channel.

**Parameter**

Name	Type	Range	Default
<cn>	Integer	1 to 500	1
<bool>	Bool	{{1 ON}} {{0 OFF}}	1 ON

**Remarks**

N/A

**Return Format**

The query returns 1 or 0.

**Example**

```
:SENSe1:CORRection:INTerpolate ON /*Enables the interpolation for
Channel 1.*/
:SENSe1:CORRection:INTerpolate? /*The query returns 1.*/
```

**6.5.4 :SENSe<cn>:CORRection:EXTension:STATe****Syntax**

```
:SENSe<cn>:CORRection:EXTension:STATe <bool>
```

```
:SENSe<cn>:CORRection:EXTension:STATe?
```

**Description**

Enables or disables the port extension for each port of the specified channel.

Queries the on/off status of the port extension for each port of the specified channel.

**Parameter**

Name	Type	Range	Default
<cn>	Integer	1 to 500	1
<bool>	Bool	{{1 ON}} {{0 OFF}}	0 OFF

**Remarks**

N/A

**Return Format**

The query returns 1 or 0.

**Example**

```
:SENSe1:CORRection:EXTension:STATe ON /*Enables the port extension
for Channel 1.*/
:SENSe1:CORRection:EXTension:STATe? /*The query returns 1.*/
```

**6.5.5 :SENSe<cn>:CORRection:EXTension:RESet****Syntax**

```
:SENSe<cn>:CORRection:EXTension:RESet
```

**Description**

Clears the delay and loss data of the port to prepare for a new measurement.

**Parameter**

Name	Type	Range	Default
<cn>	Integer	1 to 500	1

**Remarks**

N/A

**Return Format**

N/A

**Example**

N/A

**6.5.6 :SENSe<cn>:CORRection:EXTension:PORT:UNIT****Syntax**

```
:SENSe<cn>:CORRection:EXTension:PORT:UNIT <enum>
```

```
:SENSe<cn>:CORRection:EXTension:PORT:UNIT?
```

**Description**

Sets the delay distance unit for the port extension for the specified channel.

Queries the delay distance unit for the port extension for the specified channel.

**Parameter**

Name	Type	Range	Default
<cn>	Integer	1 to 500	1
<enum>	Discrete	{METer FEET INCH}	METer

**Remarks**

The parameter <enum> can be set to METer, FEET, or INCH.

**Return Format**

The query returns MET, FEET, or INCH.

**Example**

```
:SENSe1:CORRection:EXTension:PORT:UNIT FEET /*Sets the delay
distance unit to FEET.*/
:SENSe1:CORRection:EXTension:PORT:UNIT? /*The query returns FEET.*/
```

## 6.5.7 :SENSe<cn>:CORRection:EXTension:PORT<pn>[:TIME]

**Syntax**

```
:SENSe<cn>:CORRection:EXTension:PORT<pn>[:TIME] <value>
```

```
:SENSe<cn>:CORRection:EXTension:PORT<pn>[:TIME]?
```

**Description**

Sets the delay time for the port extension of the specified port for the specified channel.

Queries the delay time for the port extension of the specified port for the specified channel.

**Parameter**

Name	Type	Range	Default
<cn>	Integer	1 to 500	1
<pn>	Integer	Refer to Remarks	1
<value>	Real	-1 to 1	0

**Remarks**

This command is valid when the port extension is enabled (*:SENSe<cn>:CORRection:EXTension:STATE*).

- For DNA6082-R, DNA6142-R, DNA6202-R, and DNA6262-R, <pn> can be set to 1 or 2.
- For DNA6084-R, DNA6144-R, DNA6204-R, and DNA6264-R, <pn> can be set to 1, 2, 3, or 4.

**Return Format**

The query returns the delay time in port extension in scientific notation. The unit is s.

**Example**

```
:SENSe1:CORRection:EXTension:PORT1 0.01 /*Sets the delay time of
Port 1 extension for Channel 1 to 0.01 s.*/
:SENSe1:CORRection:EXTension:PORT1? /*The query returns 1.00e-02.*/
```

## 6.5.8 :SENSe<cn>:CORRection:EXTension:PORT<pn>:DISTance

**Syntax**

```
:SENSe<cn>:CORRection:EXTension:PORT<pn>:DISTance <value>
```

```
:SENSe<cn>:CORRection:EXTension:PORT<pn>:DISTance?
```

**Description**

Sets the delay distance for the port extension for the specified channel.

Queries the delay distance for the port extension for the specified channel.

**Parameter**

Name	Type	Range	Default
<cn>	Integer	1 to 500	1
<pn>	Integer	Refer to Remarks	1
<value>	Real	Refer to Remarks	-

**Remarks**

This command is valid when the port extension is enabled (*:SENSe<cn>:CORRection:EXTension:STATE*).

Before running this command, first run the *:SENSe<cn>:CORRection:EXTension:PORT:UNIT* command to set the distance unit.

- For DNA6082-R, DNA6142-R, DNA6202-R, and DNA6262-R, <pn> can be set to 1 or 2.
- For DNA6084-R, DNA6144-R, DNA6204-R, and DNA6264-R, <pn> can be set to 1, 2, 3, or 4.

### Return Format

The query returns the delay distance in port extension in scientific notation. The unit is m.

### Example

```
:SENSe1:CORRection:EXTension:PORT1 0.000001 /*Sets the delay
distance of Port 1 for Channel 1 to 0.001 mm.*/
:SENSe1:CORRection:EXTension:PORT1:DIStance? /*The query returns
1.00e-05.*/
```

## 6.5.9 :SENSe<cn>:CORRection:EXTension:PORT<pn>:LDC

### Syntax

```
:SENSe<cn>:CORRection:EXTension:PORT<pn>:LDC <value>
```

```
:SENSe<cn>:CORRection:EXTension:PORT<pn>:LDC?
```

### Description

Sets the loss at DC for the specified port and channel.

Queries the loss at DC for the specified port and channel.

### Parameter

Name	Type	Range	Default
<cn>	Integer	1 to 500	1
<pn>	Integer	Refer to Remarks	1
<value>	Real	-90 dB to 90 dB	0

### Remarks

This command is valid when the port extension is enabled (`:SENSe<cn>:CORRection:EXTension:STATE`).

Note that this command will affect all the measurements on the specified channel.

- For DNA6082-R, DNA6142-R, DNA6202-R, and DNA6262-R, <pn> can be set to 1 or 2.

- For DNA6084-R, DNA6144-R, DNA6204-R, and DNA6264-R, <pn> can be set to 1, 2, 3, or 4.

### Return Format

The query returns the loss at DC for the specified port in scientific notation. The unit is dB.

### Example

```
:SENSe1:CORRection:EXTension:PORT1:LDC 10 /*Sets the cable loss for
Port1 to 10 dB.*/
:SENSe1:CORRection:EXTension:PORT1:LDC? /*The query returns 1.00e
+01.*/
```

## 6.5.10 :SENSe<cn>:CORRection:EXTension:PORT<pn>:SYSVelocity

### Syntax

```
:SENSe<cn>:CORRection:EXTension:PORT<pn>:SYSVelocity <bool>
```

```
:SENSe<cn>:CORRection:EXTension:PORT<pn>:SYSVelocity?
```

### Description

Enables or disables the coupling state between port extension velocity factor and the system velocity factor.

Queries the coupling state between port extension velocity factor and the system velocity factor.

### Parameter

Name	Type	Range	Default
<cn>	Integer	1 to 500	1
<pn>	Integer	Refer to Remarks	1
<bool>	Bool	{{1 ON}}{0 OFF}}	0 OFF

### Remarks

- For DNA6082-R, DNA6142-R, DNA6202-R, and DNA6262-R, <pn> can be set to 1 or 2.
- For DNA6084-R, DNA6144-R, DNA6204-R, and DNA6264-R, <pn> can be set to 1, 2, 3, or 4.

- When the coupling relationship between the port extension velocity factor and the system velocity factor is enabled, modifying the port extension velocity factor will also change the velocity factor in electrical delay, DTF, and TDA settings. To query the velocity factor for port extension, run the `:SENSe<cn>:CORRection:EXTension:PORT<pn>:SYSVelocity` command; to query the velocity factor for DTF, run the `:CALCulate<cn>:MEASure<mn>:TRANSform:DTFault:VELOCITY` command.
- When the coupling relationship between the port extension velocity factor and the system velocity factor is disabled, modifying the port extension velocity factor will not change the velocity factor in other functions.

#### Return Format

The query returns 1 or 0.

#### Example

```
:SENSe1:CORRection:EXTension:PORT1:SYSVelocity ON /*Enables the
coupling to system velocity factor for Port 1 in Channel 1.*/
:SENSe1:CORRection:EXTension:PORT1:SYSVelocity? /*The query returns
1.*/
```

## 6.5.11 :SENSe<cn>:CORRection:EXTension:PORT<pn>:VELFactor

#### Syntax

```
:SENSe<cn>:CORRection:EXTension:PORT<pn>:VELFactor <value>
```

```
:SENSe<cn>:CORRection:EXTension:PORT<pn>:VELFactor?
```

#### Description

Sets the velocity factor for the port extension of the specified port for the specified channel.

Queries the velocity factor for the port extension of the specified port for the specified channel.

#### Parameter

Name	Type	Range	Default
<cn>	Integer	1 to 500	1
<pn>	Integer	Refer to Remarks	1
<value>	Real	0 to 1	0.66

**Remarks**

This command is valid when the port extension is enabled  
(*:SENSe<cn>:CORRection:EXTension:STATE*).

- For DNA6082-R, DNA6142-R, DNA6202-R, and DNA6262-R, <pn> can be set to 1 or 2.
- For DNA6084-R, DNA6144-R, DNA6204-R, and DNA6264-R, <pn> can be set to 1, 2, 3, or 4.

**Return Format**

The query returns the port extension velocity factor in scientific notation.

**Example**

```
:SENSe1:CORRection:EXTension:PORT1:VELFactor 0.7 /*Sets the port
extension velocity factor for Port 1 in Channel 1 to 0.7.*/
:SENSe1:CORRection:EXTension:PORT1:VELFactor? /*The query returns
7.00e-01.*/
```

## 6.5.12 :SENSe<cn>:CORRection:EXTension:PORT<pn>:INCLude<lossid>[:STATE]

**Syntax**

```
:SENSe<cn>:CORRection:EXTension:PORT<pn>:INCLude<lossid>[:STATE]
<bool>
```

```
:SENSe<cn>:CORRection:EXTension:PORT<pn>:INCLude<lossid>[:STATE]?
```

**Description**

Enables or disables the specified Freq and Loss pair number and for the specified port of the specified channel.

Queries the on/off status for Freq and Loss pair number and for the specified port of the specified channel.

**Parameter**

Name	Type	Range	Default
<cn>	Integer	1 to 500	1
<pn>	Integer	Refer to Remarks	1
<lossid>	Integer	1 to 2	1
<bool>	Bool	{{1 ON}}{0 OFF}}	0 OFF

**Remarks**

<lossid> corresponds to two groups of loss values at specific frequencies.

- For DNA6082-R, DNA6142-R, DNA6202-R, and DNA6262-R, <pn> can be set to 1 or 2.
- For DNA6084-R, DNA6144-R, DNA6204-R, and DNA6264-R, <pn> can be set to 1, 2, 3, or 4.

**Return Format**

The query returns 1 or 0.

**Example**

```
:SENSe1:CORRection:EXTension:PORT1:INCLude1 ON /*Enables the Loss1
at Freq1 for Port 1 of Channel 1.*/
:SENSe1:CORRection:EXTension:PORT1:INCLude1? /*The query returns
1.*/
```

## 6.5.13 :SENSe<cn>:CORRection:EXTension:PORT<pn>:FREQuency<lossid>

**Syntax**

```
:SENSe<cn>:CORRection:EXTension:PORT<pn>:FREQuency<lossid> <value>
```

```
:SENSe<cn>:CORRection:EXTension:PORT<pn>:FREQuency<lossid>?
```

**Description**

Sets the frequency value for the Freq and Loss pair number and for the specified port of the specified channel.

Queries the frequency value for the Freq and Loss pair number and for the specified port of the specified channel.

**Parameter**

Name	Type	Range	Default
<cn>	Integer	1 to 500	1
<pn>	Integer	Refer to Remarks	1
<lossid>	Integer	1 or 2	1
<value>	Real	Refer to Remarks	0

**Remarks**

This command is valid when the port extension is enabled (`:SENSe<cn>:CORRection:EXTension:STate`).

To set or query the port extension cable loss, run the `:SENSe<cn>:CORRection:EXTension:PORT<pn>:LOSS<lossid>` command.

- For DNA6082-R, DNA6142-R, DNA6202-R, and DNA6262-R, <pn> can be set to 1 or 2.
- For DNA6084-R, DNA6144-R, DNA6204-R, and DNA6264-R, <pn> can be set to 1, 2, 3, or 4.
- <lossid> indicates the Freq and Loss pair number. It can be set to 1 or 2.
- <value> indicates the frequency value. Its range is related to the product model.

For details about the product model.

**Return Format**

The query returns the frequency value for the Freq and Loss pair number and for the specified port of the specified channel in scientific notation. The unit is Hz.

**Example**

```
:SENSe1:CORRection:EXTension:PORT1:FREQuency1 5000 /*Sets the
frequency value for the Freq1@Loss1 pair for Port1 of Channel to 5
kHz.*/
:SENSe1:CORRection:EXTension:PORT1:FREQuency1? /*The query returns
5.00e+03.*/
```

## 6.5.14 :SENSe<cn>:CORRection:EXTension:PORT<pn>:LOSS<lossid>

**Syntax**

```
:SENSe<cn>:CORRection:EXTension:PORT<pn>:LOSS<lossid> <value>
:SENSe<cn>:CORRection:EXTension:PORT<pn>:LOSS<lossid>?
```

**Description**

Sets the loss value for the Freq and Loss pair number and for the specified port of the specified channel.

Queries the loss value for the Freq and Loss pair number and for the specified port of the specified channel.

**Parameter**

Name	Type	Range	Default
<cn>	Integer	1 to 500	1
<pn>	Integer	Refer to Remarks	1
<lossid>	Integer	1 or 2	1
<value>	Real	-90 to 90	0

**Remarks**

This command is valid when the port extension is enabled (*:SENSe<cn>:CORRection:EXTension:STate*).

- For DNA6082-R, DNA6142-R, DNA6202-R, and DNA6262-R, <pn> can be set to 1 or 2.
- For DNA6084-R, DNA6144-R, DNA6204-R, and DNA6264-R, <pn> can be set to 1, 2, 3, or 4.
- <lossid> indicates the Freq and Loss pair number. It can be set to 1 or 2.

**Return Format**

The query returns the loss value for the Freq and Loss pair number and for the specified port of the specified channel in scientific notation. The unit is dB.

**Example**

```
:SENSe1:CORRection:EXTension:PORT1:LOSS1 5 /*Sets the Loss1 value
for the Freq1@Loss1 pair for Port 1 of Channel 1 to 5 dB.*/
:SENSe1:CORRection:EXTension:PORT1:LOSS1? /*The query returns 5.00e
+00.*/
```

**6.5.15 :SENSe<cn>:CORRection:EXTension:AUTO:PORT****Syntax**

```
:SENSe<cn>:CORRection:EXTension:AUTO:PORT<pn> <bool>
```

```
:SENSe<cn>:CORRection:EXTension:AUTO:PORT<pn>?
```

**Description**

Enables or disables the APE function for the specified port of the specified channel.

Queries the on/off status of the APE function for the specified port of the specified channel.

**Parameter**

Name	Type	Range	Default
<cn>	Integer	1 to 500	1
<pn>	Integer	Refer to Remarks	1
<bool>	Bool	{{1 ON}} {{0 OFF}}	1 ON

**Remarks**

N/A

**Return Format**

The query returns 1 or 0.

**Example**

```
:SENSe1:CORRection:EXTension:AUTO:PORT1 ON /*Enables APE for Port 1
of Channel 1.*/
:SENSe1:CORRection:EXTension:AUTO:PORT1? /*The query returns 1.*/
```

## 6.5.16 :SENSe<cn>:CORRection:EXTension:AUTO:CONFig

**Syntax**

```
:SENSe<cn>:CORRection:EXTension:AUTO:CONFig <type>
:SENSe<cn>:CORRection:EXTension:AUTO:CONFig?
```

**Description**

Sets the frequency span mode of the APE function for the specified port of the specified channel.

Queries the frequency span mode of the APE function for the specified port of the specified channel.

**Parameter**

Name	Type	Range	Default
<cn>	Integer	1 to 500	1
<type>	Discrete	CSPN AMKR USPN	CSPN

**Remarks**

- CSPN: Current span.
- AMKR: Active marker.
- USPN: User span.

**Return Format**

The query returns CSPN, AMKR, or USPN.

**Example**

```
:SENSe1:CORRection:EXTeNsion:AUTO:CONFIg USPN /*Sets the frequency
span mode of the APE function for the specified port of the
specified channel to User Span.*/
:SENSe1:CORRection:EXTeNsion:AUTO:CONFIg? /*The query returns
USPN.*/
```

**6.5.17 :SENSe<cn>:CORRection:EXTeNsion:AUTO:START****Syntax**

```
:SENSe<cn>:CORRection:EXTeNsion:AUTO:START <value>
```

```
:SENSe<cn>:CORRection:EXTeNsion:AUTO:START?
```

**Description**

Sets the start frequency of the user-defined span for the APE function of the specified channel.

Queries the start frequency of the user-defined span for the APE function of the specified channel.

**Parameter**

Name	Type	Range	Default
<cn>	Integer	1 to 500	1
<value>	Real	Refer to Remarks	10 MHz

**Remarks**

This command takes effect when the APE frequency range mode (*:SENSe<cn>:CORRection:EXTeNsion:AUTO:CONFIg*) is set to USPN (User Span).

The range of the <freq> parameter is related to the product model. For the product model, refer to the product model table.

**Return Format**

The query returns the stop frequency in scientific notation. The unit is Hz.

**Example**

```
:SENSe1:CORRection:EXTeNsion:AUTO:START 100000000 /*Sets the start
frequency of the user-defined frequency span for the APE function
for CH1 to 100 MHz.*/
:SENSe1:CORRection:EXTeNsion:AUTO:START? /*The query returns 1.00e
+07.*/
```

## 6.5.18 :SENSe<cn>:CORRection:EXTension:AUTO:STOP

### Syntax

```
:SENSe<cn>:CORRection:EXTension:AUTO:STOP <freq>
:SENSe<cn>:CORRection:EXTension:AUTO:STOP?
```

### Description

Sets the stop frequency of the user-defined span for the APE function of the specified channel.

Queries the stop frequency of the user-defined span for the APE function of the specified channel.

### Parameter

Name	Type	Range	Default
<cn>	Integer	1 to 500	1
<freq>	Real	Refer to Remarks	-

### Remarks

This command takes effect when the APE frequency range mode (*:SENSe<cn>:CORRection:EXTension:AUTO:CONFig*) is set to USPN (User Span).

The range of the <freq> parameter is related to the product model. For the product model, refer to the product model table.

### Return Format

The query returns the stop frequency in scientific notation. The unit is Hz.

### Example

```
:SENSe1:CORRection:EXTension:AUTO:STOP 100000000 /*Sets the stop
frequency of the user-defined frequency span for Channel 1 to 100
MHz.*/
:SENSe1:CORRection:EXTension:AUTO:STOP? /*The query returns 1.00e
+07.*/
```

## 6.5.19 :SENSe<cn>:CORRection:EXTension:AUTO:LOSS

### Syntax

```
:SENSe<cn>:CORRection:EXTension:AUTO:LOSS <bool>
:SENSe<cn>:CORRection:EXTension:AUTO:LOSS?
```

### Description

Enables or disables the loss state for the APE function for the specified port of the specified channel.

Queries the on/off status of loss for the APE function for the specified port of the specified channel.

#### Parameter

Name	Type	Range	Default
<cn>	Integer	1 to 500	1
<bool>	Bool	{{1 ON}} {{0 OFF}}	0 OFF

#### Remarks

N/A

#### Return Format

The query returns 1 or 0.

#### Example

```
:SENSe1:CORRection:EXTension:AUTO:LOSS ON /*Enables the loss for the
APE function for Channel 1.*/
:SENSe1:CORRection:EXTension:AUTO:LOSS? /*The query returns 1.*/
```

## 6.5.20 :SENSe<cn>:CORRection:EXTension:AUTO:DCOffset

#### Syntax

```
:SENSe<cn>:CORRection:EXTension:AUTO:DCOffset <bool>
```

```
:SENSe<cn>:CORRection:EXTension:AUTO:DCOffset?
```

#### Description

Enables or disables the adjustment for mismatch for the APE function for the specified port of the specified channel.

Queries the on/off status of the adjustment for mismatch for the APE function for the specified port of the specified channel.

#### Parameter

Name	Type	Range	Default
<cn>	Integer	1 to 500	1
<bool>	Bool	{{1 ON}} {{0 OFF}}	0 OFF

#### Remarks

This command is valid when the "Include Losses" is enabled (`:SENSe<cn>:CORRection:EXTension:AUTO:LOSS`) for APE.

**Return Format**

The query returns 1 or 0.

**Example**

```
:SENSe1:CORRection:EXTension:AUTO:DCOFFset ON /*Enables the APE
adjustment for mismatch.*/
:SENSe1:CORRection:EXTension:AUTO:DCOFFset? /*The query returns 1.*/
```

**6.5.21 :SENSe<cn>:CORRection:EXTension:AUTO:MEASure****Syntax**

```
:SENSe<cn>:CORRection:EXTension:AUTO:MEASure <type>
```

**Description**

Sets the specified channel to perform the APE function for the specified port of the specified channel.

**Parameter**

Name	Type	Range	Default
<cn>	Integer	1 to 500	1
<type>	Discrete	OPEN SHORT	OPEN

**Remarks**

N/A

**Return Format**

N/A

**Example**

```
:SENSe1:CORRection:EXTension:AUTO:MEASure OPEN /*Performs to
measure OPEN for the APE function.*/
/*The query returns 1.*/
```

**6.5.22 :SENSe<cn>:CORRection:EXTension:AUTO:RESet****Syntax**

```
:SENSe<cn>:CORRection:EXTension:AUTO:RESet
```

**Description**

Clears the delay and loss data of the port to prepare for a new measurement in the APE function.

**Parameter**

Name	Type	Range	Default
<cn>	Integer	1 to 500	1

**Remarks**

N/A

**Return Format**

N/A

**Example**

N/A

**6.5.23 :SENSe<cn>:CORRection:COLLect:SAVE****Syntax**

:SENSe&lt;cn&gt;:CORRection:COLLect:SAVE

**Description**

Saves the calibration results.

**Parameter**

Name	Type	Range	Default
<cn>	Integer	1 to 500	1

**Remarks**

N/A

**Return Format**

N/A

**Example**

N/A

**6.5.24 :SENSe<cn>:CORRection:COLLect:METHod****Syntax**

:SENSe&lt;cn&gt;:CORRection:COLLect:METHod &lt;char&gt;

:SENSe&lt;cn&gt;:CORRection:COLLect:METHod?

**Description**

Sets the basic calibration method for the specified channel.

Queries the basic calibration method for the specified channel.

#### Parameter

Name	Type	Range	Default
<cn>	Integer	1 to 500	1
<char>	Discrete	NONE BASic RESP RPOWer	NONE

#### Remarks

N/A

#### Return Format

The query returns NONE, BAS, RESP, or RPOW.

#### Example

```
:SENSe1:CORRection:COLLect:METhod /*Sets the basic calibration
method for CH1 to RESP.*/
:SENSe1:CORRection:COLLect:METhod? /*The query returns RESP.*/
```

## 6.5.25 :SENSe<cn>:CORRection:COLLect[:ACQuire]

#### Syntax

```
:SENSe<cn>:CORRection:COLLect[:ACQuire] <char>
```

#### Description

Acquires the standards data.

#### Parameter

Name	Type	Range	Default
<cn>	Integer	1 to 500	1
<char>	String	-	-

#### Remarks

N/A

#### Return Format

N/A

#### Example

N/A

## 6.5.26 :SENSe<cn>:CORRection:SFORward[:STATe]

### Syntax

```
:SENSe<cn>:CORRection:SFORward[:STATe] <bool>
```

```
:SENSe<cn>:CORRection:SFORward[:STATe]?
```

### Description

Sets whether the direction of the basic calibration for the specified channel is forward.

Queries whether the direction of the basic calibration for the specified channel is forward.

### Parameter

Name	Type	Range	Default
<cn>	Integer	1 to 500	1
<bool>	Bool	{{1 ON}}{0 OFF}}	0 OFF

### Remarks

N/A

### Return Format

The query returns 1 or 0.

### Example

```
:SENSe1:CORRection:SFORward ON /*Sets the direction of the basic
calibration for Channel 1 to Forward.*/
:SENSe1:CORRection:SFORward? /*The query returns 1.*/
```

## 6.5.27 :SENSe<cn>:CORRection:TSTandards[:STATe]

### Syntax

```
:SENSe<cn>:CORRection:TSTandards[:STATe] <bool>
```

```
:SENSe<cn>:CORRection:TSTandards[:STATe]?
```

### Description

Sets whether the specified channel calibration uses two sets of standards.

Queries whether the specified channel calibration uses two sets of standards.

### Parameter

Name	Type	Range	Default
<cn>	Integer	1 to 500	1

Name	Type	Range	Default
<bool>	Bool	{{1 ON}} {{0 OFF}}	0 OFF

**Remarks**

N/A

**Return Format**

The query returns 1 or 0.

**Example**

```
:SENSe1:CORRection:TSTandards ON /*Enables Channel 1 calibration to
use two sets of standards.*/
:SENSe1:CORRection:TSTandards? /*The query returns 1.*/
```

## 6.5.28 :SENSe<cn>:CORRection:DATA:CDATA?

**Syntax**

```
:SENSe<CN>:CORRection:DATA:CDATA?
```

**Description**

Queries the corrected data after trace calibration.

**Parameter**

Name	Type	Range	Default
<cn>	Integer	1 to 500	1

**Remarks**

N/A

**Return Format**

The query returns the corrected data after trace calibration in strings.

## 6.5.29 :SENSe:CORRection:COLLect:GUIDed:CONNector:CATalog?

**Syntax**

```
:SENSe:CORRection:COLLect:GUIDed:CONNector:CATalog?
```

**Description**

Queries the valid connector types supported for the available calibration kits.

**Parameter**

N/A

**Remarks**

N/A

**Return Format**

The query returns a list of valid connector types in strings, separated by commas. For example, APC 3.5,Type F (75),Type N (75),APC 2.4,Type N (50),7-16,APC 7.

**Example**

N/A

### 6.5.30 :SENSe:CORRection:COLLect:GUIDed:CKIT:CATalog?

**Syntax**

```
:SENSe:CORRection:COLLect:GUIDed:CKIT:CATalog? <connector>
```

**Description**

Queries the valid calibration kits that use the specified type of the connector.

**Parameter**

Name	Type	Range	Default
<connector>	ASCII Strings	-	-

**Remarks**

<connector> indicates the type of the connector. To query the valid connector types, run the *:SENSe:CORRection:COLLect:GUIDed:CONNector:CATalog?* command.

**Return Format**

The query returns the valid calibration kits that use the specified type of the connector, separated by commas. For example, 85052D/85033D/E.

**Example**

```
:SENSe:CORRection:COLLect:GUIDed:CKIT:CATalog? APC 3.5
```

### 6.5.31 :SENSe:CORRection:CKIT:INITialize[:IMMediate]

**Syntax**

```
:SENSe:CORRection:CKIT:INITialize[:IMMediate]
```

**Description**

Restores all the installed calibration kits to the factory defaults.

**Parameter**

N/A

**Remarks**

This command can also delete all the existing user-defined calibration kits. If you want to use them, first run the `:SENSe:CORRection:CKIT:EXPort` command to save the calibration kits.

**Return Format**

N/A

**Example**

N/A

### 6.5.32 :SENSe:CORRection:CKIT:CLEAr[:IMMediate]

**Syntax**

```
:SENSe:CORRection:CKIT:CLEAr[:IMMediate] <kit>
```

**Description**

Deletes the installed calibration kits.

**Parameter**

Name	Type	Range	Default
<kit>	ASCII Strings	-	-

**Remarks**

<kit> indicates "Kit Name" specified in the Standard Cal Kits list.

**Return Format**

N/A

**Example**

```
:SENSe:CORRection:CKIT:CLEAr 85056D
```

### 6.5.33 :SENSe:CORRection:CKIT:COUNT?

**Syntax**

```
:SENSe:CORRection:CKIT:COUNT?
```

**Description**

Queries the number of installed calibration kits.

**Parameter**

N/A

**Remarks**

N/A

**Return Format**

The query returns the number of installed calibration kits in integer.

**Example**

N/A

**6.5.34 :SENSe:CORRection:CKIT:IMPoRT****Syntax**

```
:SENSe:CORRection:CKIT:IMPoRT <file_name>
```

**Description**

Loads the specified calibration kit (\*.xkt file) from the specified path and appends the imported kit to the end of the kits list.

**Parameter**

Name	Type	Range	Default
<file_name>	ASCII Strings	-	-

**Remarks**

<file\_name> indicates the saved path and filename.

**Return Format**

N/A

**Example**

```
:SENSe:CORRection:CKIT:IMPoRT NewCalKit.xkt /*Loads the calibration kit file named NewCalKit.xkt.*/
```

**6.5.35 :SENSe:CORRection:CKIT:EXPoRT****Syntax**

```
:SENSe:CORRection:CKIT:EXPoRT <kit>,<file_name>
```

**Description**

Saves the specified calibration kits as a file suffixed with "\*.xkt" to the specified path.

**Parameter**

Name	Type	Range	Default
<kit>	ASCII Strings	-	-
<file_name>	ASCII Strings	-	-

**Remarks**

This command is used to archive or move a user-defined or modified calibration kits to a different VNA. After exporting the calibration kits, use the *:SENSe:CORRection:CKIT:IMPort* command to make the calibration kit available for use on the other VNA.

<kit> indicates "Kit Name" specified in the Standard Cal Kits list to be exported.

<file\_name> indicates the path and filename of the calibration kit file to be saved.

**Return Format**

N/A

**Example**

```
:SENSe:CORRection:CKIT:EXPort 85054D,NewCalKit.xkt /*Saves the
calibration kit 85054D as a file named NewCalKit.xkt to the default
path.*/
```

**6.5.36 :SENSe:CORRection:CKIT:LOAD****Syntax**

```
:SENSe:CORRection:CKIT:LOAD <file_name>
```

**Description**

Loads the specified file suffixed with "\*.xkw" from the specified path to the calibration kits workspace.

**Parameter**

Name	Type	Range	Default
<file_name>	ASCII Strings	-	-

**Remarks**

<file\_name> indicates the path and filename to be loaded.

**Return Format**

N/A

**Example**

```
:SENSe:CORRection:CKIT:LOAD NewFile.xkw /*Loads the file
NewFile.xkw.*/
```

**6.5.37 :SENSe:CORRection:IMPedance:INPut:MAGNitude****Syntax**

```
:SENSe:CORRection:IMPedance:INPut:MAGNitude <value>
```

```
:SENSe:CORRection:IMPedance:INPut:MAGNitude?
```

**Description**

Sets the system impedance of VNA.

Queries the system impedance of VNA.

**Parameter**

Name	Type	Range	Default
<value>	Real	0.001 $\Omega$ to 1000 $\Omega$	50 $\Omega$

**Remarks**

N/A

**Return Format**

The query returns the system impedance in scientific notation. The unit is  $\Omega$ .

**Example**

```
:SENSe:CORRection:IMPedance:INPut:MAGNitude 100 /*Sets the system
impedance to 100  $\Omega$ .*/
:SENSe:CORRection:IMPedance:INPut:MAGNitude? /*The query returns
1.00+02e.*/
```

**6.6 :SENSe<cn>:AVERage Commands**

The :SENSe<cn>:AVERage commands are used to set and query the Averaging relevant parameters for measurement.

**6.6.1 :SENSe<cn>:AVERage:MODE****Syntax**

```
:SENSe<cn>:AVERage:MODE <type>
```

```
:SENSe<cn>:AVERage:MODE?
```

**Description**

Sets the average type for the specified channel.

Queries the average type for the specified channel.

#### Parameter

Name	Type	Range	Default
<cn>	Integer	1 to 500	1
<type>	Discrete	{POINT SWEep}	SWEep

#### Remarks

- POINT: Point Averaging. Each data point is measured for a specified number of times, then averaged, before going to the next data point.
- SWEep: Sweep Averaging. Computes averaging on subsequent sweeps until the required number of averaging sweeps are performed.

#### Return Format

The query returns POIN or SWE.

#### Example

```
:SENSe1:AVERAge:MODE SWEep /*Sets the average type for Channel 1 to SWEep.*/
:SENSe1:AVERAge:MODE? /*The query returns SWE.*/
```

## 6.6.2 :SENSe<cn>:AVERAge[:STATe]

#### Syntax

```
:SENSe<cn>:AVERAge[:STATe] <bool>
```

```
:SENSe<cn>:AVERAge[:STATe]?
```

#### Description

Enables or disables Average state for the specified channel.

Queries the on/off status of the Average state for the specified channel.

#### Parameter

Name	Type	Range	Default
<cn>	Integer	1 to 500	1
<bool>	Bool	{{1 ON}} {{0 OFF}}	0 OFF

#### Remarks

N/A

**Return Format**

The query returns 1 or 0.

**Example**

```
:SENSe1:AVERAge ON /*Enables the Average state for Channel 1.*/
:SENSe1:AVERAge? /*The query returns 1.*/
```

**6.6.3 :SENSe<cn>:AVERAge:COUNT****Syntax**

```
:SENSe<cn> :AVERAge:COUNT <count>
```

```
:SENSe<cn> :AVERAge:COUNT?
```

**Description**

Sets the number of sweep averaging times for the specified channel.

Queries the number of sweep averaging times for the specified channel.

**Parameter**

Name	Type	Range	Default
<cn>	Integer	1 to 500	1
<count>	Integer	1 to 65535	1

**Remarks**

To run this command, first set the `:SENSe<cn>:AVERAge[:STATe]` to ON to enable the average state.

**Return Format**

The query returns the average count in integer.

**Example**

```
:SENSe1:AVERAge:COUNT 10 /*Sets the average count for Channel 1
measurement to 10.*/
:SENSe1:AVERAge:COUNT? /*The query returns 10.*/
```

**6.6.4 :SENSe<cn>:AVERAge:CLEAr****Syntax**

```
:SENSe<cn> :AVERAge:CLEAr
```

**Description**

Clears the measurement data of the specified channel and restarts averaging again for a new set of measurements.

**Parameter**

Name	Type	Range	Default
<cn>	Integer	1 to 500	1

**Remarks**

N/A

**Return Format**

N/A

**Example**

N/A

## 6.7 :SENSe<cn>:COUPle:PARAmeter[:STATe]

**Syntax**

```
:SENSe<cn>:COUPle:PARAmeter[:STATe] <bool>
```

```
:SENSe<cn>:COUPle:PARAmeter[:STATe]?
```

**Description**

Enables or disables the coupling state in the time domain setup for the specified channel.

Queries the on/off status of coupling in the time domain setup for the specified channel.

**Parameter**

Name	Type	Range	Default
<cn>	Integer	1 to 500	1
<bool>	Bool	{{1 ON}} {{0 OFF}}	1 ON

**Remarks**

- **ON:** enables the coupling state. When it is enabled, modifications of the transform parameters and gating parameters for the current active trace are global to all the traces of the current channel.
- **OFF:** disables the coupling state. When it is disabled, modifications of the transform parameters and gating parameters for the current active trace will not affect the other traces of the current channel.

- To select the transform parameters to be coupled, run  
the *:CALCulate<cn>:MEASure<mn>:TRANSform:COUple:PARAmeters*
- To select the time gating parameters to be coupled, run  
the *:CALCulate<cn>:MEASure<mn>:FILTer:GATE:COUple:PARAmeters*

### Return Format

The query returns 1 or 0.

### Example

```
:SENSe1:COUple:PARAmeter ON /*Enables the coupling state in the  
time domain setup for Channel 1.*/  
:SENSe1:COUple:PARAmeter? /*The query returns 1.*/
```

## 7 :CALCulate<cn> Commands

In the :CALCulate<cn> commands, <cn> indicates the existing channel number.

### 7.1 :CALCulate<cn>:PARAmeter:CATalog:EXTended?

#### Syntax

```
:CALCulate<cn>:PARAmeter:CATalog:EXTended? <type>
```

#### Description

Queries all of the measurement trace names and parameters for the specified channel.

#### Parameter

Name	Type	Range	Default
<cn>	Integer	1 to 500	1
<type>	Discrete	{NORMAL DISPlay DEFine}	NORMAL

#### Remarks

- DISPlay/NORMAL:** If the trace title is enabled (`:DISPlay:MEASure<mn>:TITLe[:STATe]`), then the returned name is the same as the trace title. If the trace title is disabled, then the returned name is the same as the trace measurement parameter name.
- DEFine:** The returned name is always the same as the trace measurement parameter name, no matter the trace title is enabled or disabled.

#### Return Format

The query returns the trace names and parameters of the trace measurement in strings, separated by commas.

#### Example

```
:CALCulate1:PARAmeter:CATalog:EXTended? DISPlay /*The query returns CH1_S11_1,S11.*/
```

### 7.2 :CALCulate<cn>:PARAmeter[:DEFine]:EXTended

#### Syntax

```
:CALCulate<cn>:PARAmeter[:DEFine]:EXTended <Mname>,<param>
```

**Description**

Creates the trace title and measurement parameter trace for the specified channel.

**Parameter**

Name	Type	Range	Default
<cn>	Integer	1 to 500	1
<Mname>	ASCII String	Refer to Remarks	-
<param>	ASCII String	Refer to Remarks	-

**Remarks**

- <Mname> indicates the title of the measurement trace. After completing the creation of the trace title, you can run the `:DISPlay:MEASure<mn>:TITLe:DATA` command to query the measurement trace title.
- <param> indicates the measurement S-parameter to be created. For example, S21, S12, S11, and S22.

**Return Format**

N/A

**Example**

```
:CALCulate1:PARAmeter:EXTended Tr1,S21 /*Creates Tr1 trace for S21
measurement parameter.*/
```

## 7.3 :CALCulate<cn>:PARAmeter:COUNT

**Syntax**

```
:CALCulate<cn>:PARAmeter:COUNT <param>
```

```
:CALCulate<cn>:PARAmeter:COUNT?
```

**Description**

Sets the number of traces created for the specified channel.

Queries the number of traces created for the specified channel.

**Parameter**

Name	Type	Range	Default
<cn>	Integer	1 to 500	1

Name	Type	Range	Default
<param>	Integer	1 to 50000	-

**Remarks**

N/A

**Return Format**

The query returns the number of traces created for the specified channel in integer.

**Example**

```
:CALCulate1:PARAmeter:COUNT 5 /*Sets the number of traces created
for CH1 to 5.*/
:CALCulate1:PARAmeter:COUNT? /*The query returns 5.*/
```

## 7.4 :CALCulate<cn>:PARAmeter:SElect

**Syntax**

```
:CALCulate<cn>:PARAmeter:SElect <Mname>
```

```
:CALCulate<cn>:PARAmeter:SElect?
```

**Description**

Selects the trace of the specified channel.

Queries the trace of the specified channel.

**Parameter**

Name	Type	Range	Default
<cn>	Integer	1 to 500	1
<Mname>	String	-	-

**Remarks**

N/A

**Return Format**

The query returns the trace in the form of channel No.\_S-parameter\_trace number in strings.

**Example**

```
:CALCulate1:PARAmeter:SElect 1 /*Selects Trace 1.*/
:CALCulate1:PARAmeter:SElect? /*The query returns CH1_S11_1.*/
```

## 7.5 :CALCulate<cn>:PARAmeter:DELeTe[:NAME]

### Syntax

```
:CALCulate<cn>:PARAmeter:DELeTe[:NAME] <Mname>
```

### Description

Deletes the specified trace for the specified channel.

### Parameter

Name	Type	Range	Default
<cn>	Integer	1 to 500	1
<Mname>	String	-	-

### Remarks

The naming rule for the parameter <Mname> is as follows: CH<n>\_S11\_<tr>. Where, <n> indicates the channel number; <tr> indicates the trace number.

### Return Format

N/A

### Example

```
:CALCulate1:PARAmeter:DELeTe Tracel /*Deletes Tr 1 of S11 measurement for CH1.*/
```

## 7.6 :CALCulate<cn>:PARAmeter:DELeTe:ALL

### Syntax

```
:CALCulate<cn>:PARAmeter:DELeTe:ALL
```

### Description

Deletes the specified channel and all the traces of the specified channel.

### Parameter

Name	Type	Range	Default
<cn>	Integer	1 to 500	1

### Remarks

N/A

### Return Format

N/A

**Example**

```
:CALCulate1:PARAmeter:DELeTe:ALL /*Deletes Channel 1 and its
trace(s).*/
```

**7.7 :CALCulate<cn>:PARAmeter:MNUMber[:SElect]****Syntax**

```
:CALCulate<cn>:PARAmeter:MNUMber[:SElect] <mn>
```

```
:CALCulate<cn>:PARAmeter:MNUMber[:SElect]?
```

**Description**

Selects the specified trace of the specified channel.

Queries the selected trace and channel.

**Parameter**

Name	Type	Range	Default
<cn>	Integer	1 to 500	1
<mn>	Integer	1 to 50000	-

**Remarks**

<mn> must be an existing trace; otherwise this command does not take effect.

**Return Format**

The query returns the number of traces created for the specified channel in integer.

**Example**

```
:CALCulate1:PARAmeter:MNUMber 5 /*Selects Trace 5 for CH1.*/
:CALCulate1:PARAmeter:MNUMber? /*The query returns 5.*/
```

**7.8 :CALCulate<cn>:PARAmeter<mn>:DEFine****Syntax**

```
:CALCulate<cn>:PARAmeter<mn>:DEFine <string>
```

```
:CALCulate<cn>:PARAmeter<mn>:DEFine?
```

**Description**

Sets the S-parameter measurement for the specified trace.

Queries the S-parameter measurement for the specified trace.

**Parameter**

Name	Type	Range	Default
<cn>	Integer	1 to 500	1
<mn>	Integer	1 to 50000	1
<string>	String	-	-

**Remarks**

<mn> must be a trace number that already exists.

**Return Format**

The query returns the S-parameters in strings.

**Example**

```
:CALCulate1:PARAmeter1:DEFine S21 /*Sets the S-parameter of Trace
1 for CH1 to S21.*/
:CALCulate1:PARAmeter1:DEFine? /*The query returns S21.*/
```

## 7.9 :CALCulate<cn>:MEASure<mn>:PARAmeter

**Syntax**

```
:CALCulate<cn>:MEASure<mn>:PARAmeter <string>
```

```
:CALCulate<cn>:MEASure<mn>:PARAmeter?
```

**Description**

Configures the S parameter for the specified trace.

Queries the S parameter for the specified trace.

**Parameter**

Name	Type	Range	Default
<cn>	Integer	1 to 500	1
<mn>	Integer	1 to 50000	1
<string>	ASCII String	Refer to Remarks	S11

**Description**

<string> is the measurement parameters to be created. It can be set to S11, S12, S21, and S22.

- Balance S parameters (e.g. Sdd11, Sds21, with case-sensitive)

- Imbalance (Imb/Imb1/Imb2, based on the selected topology type)
- Common mode rejection ratio (CMRR/CMRR1/CMRR2, based on the selected topology type)

### Return Format

The query returns the measurement parameters in strings. For example, S11, S12, S21, or S22.

### Example

```
:CALCulate1:MEASure1:PARAmeter S12 /*Configures the measurement
parameter for Trace 1.*/
:CALCulate1:MEASure1:PARAmeter? /*The query returns S12.*/
```

## 7.10 :CALCulate<cn>:MEASure<mn>:CONVersion:FUNCTION

### Syntax

```
:CALCulate<cn>:MEASure<mn>:CONVersion:FUNCTION <type>
```

```
:CALCulate<cn>:MEASure<mn>:CONVersion:FUNCTION?
```

### Description

Sets the parameter conversion type for the specified measurement trace.

Queries the parameter conversion type for the specified measurement trace.

### Parameter

Name	Type	Range	Default
<cn>	Integer	1 to 500	1
<mn>	Integer	1 to 50000	1
<type>	Discrete	{OFF ZREFlection ZTRansmit ZTSHunt YREFlection YTRansmit YTSHunt INVersion CONJugation}	OFF

### Remarks

- OFF: disables the parameter conversion.
- ZREFlection: Z-Reflect, impedance (Zr) in reflection measurement.
- ZTRansmit: Z-Transmit, impedance (Zt) in transmission measurement.
- ZTSHunt: Z-Trans-Shunt, impedance (Zt) transmission shunt

- YREFlection: Y-Reflect, admittance (Yr) in reflection measurement.
- YTRansmit: Y-Transmit, admittance (Yt) in transmission measurement.
- YTSHunt: Y-Trans-Shunt, admittance (Yt) in transmission measurement.
- INVersion: 1/S, inverse S-Parameter.
- CONJugation: Conjugation, complex conjugate number.

### Return Format

The query returns OFF, ZREF, ZTR, ZTSH, YREF, YTR, YTSH, INV, or CONJ.

### Example

```
:CALCulate1:MEASure1:CONVersion:FUNction ZREFlection /*Sets the
parameter conversion type to ZREFlection.*/
:CALCulate1:MEASure1:CONVersion:FUNction? /*The query returns
ZREF.*/
```

## 7.11 :CALCulate<cn>:MEASure<mn>:FORMat

### Syntax

```
:CALCulate<cn>:MEASure<mn>:FORMat <type>
```

```
:CALCulate<cn>:MEASure<mn>:FORMat?
```

### Description

Sets the format type of the specified measurement trace.

Queries the format type of the specified measurement trace.

### Parameter

Name	Type	Range	Default
<cn>	Integer	1 to 500	1
<mn>	Integer	1 to 50000	1
<type>	Discrete	{MLOGarithmic MLINear PHASe UPHase  IMAGinary REAL POLar SMITH SADMittance SWR  GDELay PPHase}	MLOGarithmic

### Remarks

- MLOGarithmic: indicates log magnitude.
- MLINear: indicates linear magnitude.
- PHASe: indicates phase.

- UPHase: indicates unwrapped phase.
- IMAGinary: indicates Imaginary.
- REAL: indicates Real.
- POLar: indicates Polar format.
- SMITH: indicates Smith chart.
- SADMittance: indicates Inverted Smith.
- SWR: indicates standing wave ratio.
- GDELay: indicates group delay.
- PPHase: indicates positive phase.

### Return Format

The query returns MLOG, MLIN, PHAS, UPH, IMAG, REAL, POL, SMIT, SADM, SWR, GDEL, or PPH.

### Example

```
:CALCulate1:MEASure1:FORMat MLINear /*Sets the data format of
measurement trace 1 to MLINear.*/
:CALCulate1:MEASure1:FORMat? /*The query returns MLIN.*/
```

## 7.12 :CALCulate<cn>:FORMat

### Syntax

```
:CALCulate<cn>:FORMat <type>
```

```
:CALCulate<cn>:FORMat?
```

### Description

Sets the format type of the selected trace for the specified channel.

Queries the format type of the selected trace for the specified channel.

### Parameter

Name	Type	Range	Default
<cn>	Integer	1 to 500	1
<type>	Discrete	{MLOGarithmic MLINear PHASe UPHase  IMAGinary REAL POLar SMITH SADMittance SWR  GDELay PPHase}	MLOGarithmic

**Remarks**

- MLOGarithmic: indicates log magnitude.
- MLINear: indicates linear magnitude.
- PHASe: indicates phase.
- UPHase: indicates unwrapped phase.
- IMAGinary: indicates Imaginary.
- REAL: indicates Real.
- POLar: indicates Polar format.
- SMITH: indicates Smith chart.
- SADMittance: indicates Inverted Smith.
- SWR: indicates standing wave ratio.
- GDELay: indicates group delay.
- PPHase: indicates positive phase.

This command takes effect for the currently selected trace if the specified channel is the currently selected channel. If the specified channel is not the currently selected channel, this command only takes effect for the trace with the minimal number for the channel.

**Return Format**

The query returns MLOG, MLIN, PHAS, UPH, IMAG, REAL, POL, SMIT, SADM, SWR, GDEL, or PPH.

**Example**

```
:CALCulate1:FORMat MLINear /*Sets the data format for the trace of
Channel 1 to MLINear*/
:CALCulate1:FORMat? /*The query returns MLIN.*/
```

## 7.13 :CALCulate<cn>:DATA:SNP:PORTs?

**Syntax**

```
:CALCulate<cn>:DATA:SNP:PORTs? <ports>
```

**Description**

Queries multi-port data.

**Parameter**

Name	Type	Range	Default
<cn>	Integer	1 to 500	1
<ports>	ASCII String	Refer to Remarks	-

**Remarks**

<ports>: indicates the port number. The port number is separated by vertical bar (|).

**Return Format**

The query returns multi-port data in strings, separated by commas.

**Example**

```
:CALCulate1:DATA:SNP:PORTs? 1|2 /*The query returns +1.000000000000E+07,+1.424500000000E+08,...*/
```

## 7.14 :CALCulate<cn>:LIMit:STATe

**Syntax**

```
:CALCulate<cn>:LIMit:STATe <bool>
```

```
:CALCulate<cn>:LIMit[:STATe]?
```

**Description**

Enables or disables the limit test for the specified channel.

Queries the on/off status of the limit test for the specified channel.

**Parameter**

Name	Type	Range	Default
<cn>	Integer	1 to 500	1
<bool>	Bool	{{1 ON}} {{0 OFF}}	0 OFF

**Remarks**

N/A

**Return Format**

The query returns 1 or 0.

**Example**

```
:CALCulate1:LIMit:STATe ON /*Enables the limit test for Channel 1.*/  
:CALCulate1:LIMit? /*The query returns 1.*/*
```

## 7.15 :CALCulate<cn>:MARKer:AOff

### Syntax

```
:CALCulate<cn>:MARKer:AOff
```

### Description

Disables all the markers on the trace of the specified channel.

### Parameter

Name	Type	Range	Default
<cn>	Integer	1 to 500	1

### Remarks

When the marker couple function is disabled (`:CALCulate<cn>:MEASure<mn>:MARKer<mk>:COUpling[:STATe]`), if the specified channel is the currently selected channel, this command takes effect for the currently selected trace. If the specified channel is not the currently selected channel, this command only takes effect for the trace with the minimum number for the channel.

### Return Format

N/A

### Example

N/A

## 7.16 :CALCulate<cn>:MARKer<mk>[:STATe]

### Syntax

```
:CALCulate<cn>:MARKer<mk>[:STATe] <bool>
```

### Description

Enables or disables the state of the specified marker on the selected trace for the specified channel.

### Parameter

Name	Type	Range	Default
<cn>	Integer	1 to 500	1
<mk>	Integer	1 to 16	1
<bool>	Bool	{{1 ON}}{0 OFF}}	0 OFF

**Remarks**

When the marker couple function is disabled (`:CALCulate<cn>:MEASure<mn>:MARKer<mk>:COUPling[:STATe]`), if the specified channel is the currently selected channel, this command takes effect for the currently selected trace. If the specified channel is not the currently selected channel, this command only takes effect for the trace with the minimum number for the channel.

**Return Format**

N/A

**Example**

```
:CALCulate1:MARKer1 ON /*Enables Marker 1 on the trace of Channel 1.*/
```

## 7.17 :CALCulate<cn>:MARKer<mk>:X

**Syntax**

```
:CALCulate<cn>:MARKer<mk>:X <value>
```

```
:CALCulate<cn>:MARKer<mk>:X?
```

**Description**

Sets the Marker X value of the specified marker on the trace of the specified channel.

Queries the Marker X value of the specified marker on the trace of the specified channel.

**Parameter**

Name	Type	Range	Default
<cn>	Integer	1 to 500	1
<mk>	Integer	1 to 16	1
<value>	Real	Refer to Remarks	0

**Remarks**

When the marker couple function is disabled (`:CALCulate<cn>:MEASure<mn>:MARKer<mk>:COUPling[:STATe]`), if the specified channel is the currently selected channel, this command takes effect for the currently selected trace. If the specified channel is not the currently selected channel, this command only takes effect for the trace with the minimum number for the channel.

The parameter <value> is any X-axis position within the marker measurement span. Its unit is related to the sweep type.

**Return Format**

The query returns the Marker X value of the specified marker on the trace of the specified channel. The unit is Hz or dBm.

**Example**

```
:CALCulate1:MARKer1:X -10 /*Sets the Marker X value of Marker 1 to
-10 dBm.*/
:CALCulate1:MARKer1:X? /*The query returns -1.00e+01.*/
```

**7.18 :CALCulate<cn>:MARKer<mk>:Y?****Syntax**

```
:CALCulate<cn>:MARKer<mk>:Y?
```

**Description**

Queries the Y-axis value of the specified marker on the selected trace of the specified channel.

**Parameter**

Name	Type	Range	Default
<cn>	Integer	1 to 500	1
<mk>	Integer	1 to 16	1

**Remarks**

When the marker couple function is disabled (*:CALCulate<cn>:MEASure<mn>:MARKer<mk>:COUPling[:STATe]*), if the specified channel is the currently selected channel, this command takes effect for the currently selected trace. If the specified channel is not the currently selected channel, this command only takes effect for the trace with the minimum number for the channel.

If it is the Delta marker (*:CALCulate<cn>:MEASure<mn>:MARKer<mk>:DELTA*), the queried data are relative to the reference marker.

The format of the returned value depends on the current format setting (*:CALCulate<cn>:MEASure<mn>:FORMat*).

The query always returns two numbers:

- For Smith and Polar format, the query returns in (real, imaginary) format.
- For linear phase and log phase, the query returns in (real, imaginary) format.
- For other formats, the query returns in (return value, 0) format.

To accurately read the Y-axis value of the marker with trace smoothing applied (*:CALCulate<cn>:MEASure<mn>:SMOothing[:STATe]*), the queried marker format

must match the display format (*:CALCulate<cn>:MEASure<mn>:FORMat*) of the measurement. Otherwise, the returned values are data not having been smoothed. For example, when reading the value for smoothing in group delay format, the display format and the marker format must be set to group delay.

### Return Format

The query returns the Y-axis value of the specified marker in strings.

### Example

```
:CALCulate1:MARKer1:Y? /*The query returns -6.28006525289E+01,+
0.000000000000E+00.*/
```

## 7.19 :CALCulate<cn>:MEASure<mn>:DATA Commands

The :CALCulate<cn>:MEASure<mn>:DATA commands are used to query the measurement data.

### 7.19.1 :CALCulate<cn>:MEASure<mn>:DATA:FDATA?

#### Syntax

```
:CALCulate<cn>:MEASure<mn>:DATA:FDATA?
```

#### Description

Queries the formatted measurement data of the specified measurement trace.

#### Parameter

Name	Type	Range	Default
<cn>	Integer	1 to 500	1
<mn>	Integer	1 to 50000	1

#### Remarks

- The query returns the corrected data when the correction is enabled; returns uncorrected data when the correction is disabled. To query the on/off status of correction, run the *:SENSe<cn>:CORRection[:STATe]* command.
- Format of the read data is the same as the data format of the trace. It returns two numbers per data point for Polar and Smith Chart format; returns one number per data point for all other formats. To query the data format, run the *:CALCulate<cn>:MEASure<mn>:FORMat* command.

**Return Format**

The query returns the formatted measurement data of the specified measurement trace in strings, separated by commas.

**Example**

```
:CALCulate1:MEASure1:DATA:FDATA?
/*The query returns +2.54078560020E+02,+1.57106224633E
+02,+1.52015516428E+02,+2.88356598962E+02,+5.96257668697E
+02,+1.63830039657E+03,+2.07158456347E+02,+1.14220907764E+02...*/
```

**7.19.2 :CALCulate<cn>:MEASure<mn>:DATA:SDATA?****Syntax**

```
:CALCulate<cn>:MEASure<mn>:DATA:SDATA?
```

**Description**

Queries the raw measurement data of the specified measurement trace.

**Parameter**

Name	Type	Range	Default
<cn>	Integer	1 to 500	1
<mn>	Integer	1 to 50000	1

**Remarks**

- The query returns two numbers per data point.
- The query returns the corrected data when the correction is enabled; returns uncorrected data when the correction is disabled. To query the on/off status of correction, run the `:SENSe<cn>:CORRection[:STATE]` command.

**Return Format**

The query returns the raw measurement data of the specified measurement trace in strings, separated by commas.

**Example**

```
:CALCulate1:MEASure1:DATA:SDATA?
/*The query returns -1.00561120086E
+00,+9.16885742909E-02,-9.64400034902E-01,+3.14083834752E-01,-8.9519
5231649E-01,+4.73009288675E-01,-8.07400742735E-01,+6.14844129671E-01
...*/
```

### 7.19.3 :CALCulate<cn>:MEASure<mn>:DATA:X[:VALues]?

#### Syntax

```
:CALCulate<cn>:MEASure<mn>:DATA:X[:VALues]?
```

#### Description

Queries the X-axis stimulus value of the specified measurement trace.

#### Parameter

Name	Type	Range	Default
<cn>	Integer	1 to 500	1
<mn>	Integer	1 to 50000	1

#### Remarks

N/A

#### Return Format

The query returns the X-axis stimulus value of the specified measurement trace in strings, separated by commas.

#### Example

```
:CALCulate1:MEASure1:DATA:X?
/*The query returns +1.000000000000E+07,+5.245000000000E
+07,+9.490000000000E+07,+1.373500000000E+08,+1.798000000000E
+08,+2.222500000000E+08,+2.647000000000E+08,+3.071500000000E+080E
+08...*/
```

## 7.20 :CALCulate<cn>:MEASure<mn>:HOLD Commands

The :CALCulate<cn>:MEASure<mn>:HOLD commands are used to set and query the trace hold function parameters.

### 7.20.1 :CALCulate<cn>:MEASure<mn>:HOLD:TYPE

#### Syntax

```
:CALCulate<cn>:MEASure<mn>:HOLD:TYPE <type>
```

```
:CALCulate<cn>:MEASure<mn>:HOLD:TYPE?
```

#### Description

Sets the trace hold type of the specified measurement trace.

Queries the trace hold type of the specified measurement trace.

**Parameter**

Name	Type	Range	Default
<cn>	Integer	1 to 500	1
<mn>	Integer	1 to 50000	1
<type>	Discrete	{OFF MINimum MAXimum}	OFF

**Remarks**

- OFF: disables the trace hold function.
- MINimum: Sets Trace Hold to store the lowest measured data points.
- MAXimum: Sets Trace Hold to store the highest measured data points.

**Return Format**

The query returns OFF, MIN, or MAX.

**Example**

```
:CALCulate1:MEASure1:HOLD:TYPE MAXimum /* Sets Trace Hold to store
the highest measured data points.*/
:CALCulate1:MEASure1:HOLD:TYPE? /*The query returns MAX.*/
```

## 7.20.2 :CALCulate<cn>:MEASure<mn>:HOLD:CLEAr

**Syntax**

```
:CALCulate<cn>:MEASure<mn>:HOLD:CLEAr
```

**Description**

Sets to restart the trace hold function of the specified measurement trace.

**Parameter**

Name	Type	Range	Default
<cn>	Integer	1 to 500	1
<mn>	Integer	1 to 50000	1

**Remarks**

This command restarts the trace hold function and then launch the measurement based on the currently selected trace hold type.

**Return Format**

N/A

**Example**

N/A

**7.21 :CALCulate<cn>:MEASure<mn>:MATH Commands**

The :CALCulate<cn>:MEASure<mn>:MATH commands are used to set and query the Math operation function parameters.

**7.21.1 :CALCulate<cn>:MEASure<mn>:MATH:MEMorize****Syntax**

```
:CALCulate<cn>:MEASure<mn>:MATH:MEMorize
```

**Description**

Stores the measurement data of the specified measurement trace into memory.

**Parameter**

Name	Type	Range	Default
<cn>	Integer	1 to 500	1
<mn>	Integer	1 to 50000	1

**Remarks**

N/A

**Return Format**

N/A

**Example**

N/A

**7.21.2 :CALCulate<cn>:MEASure<mn>:MATH:NORMalize****Syntax**

```
:CALCulate<cn>:MEASure<mn>:MATH:NORMalize
```

**Description**

Performs Normalization operation on the measurement data of the specified measurement trace.

**Parameter**

Name	Type	Range	Default
<cn>	Integer	1 to 500	1
<mn>	Integer	1 to 50000	1

**Remarks**

N/A

**Return Format**

N/A

**Example**

N/A

**7.21.3 :CALCulate<cn>:MEASure<mn>:MATH:MEMory:STATe?****Syntax**

:CALCulate&lt;cn&gt;:MEASure&lt;mn&gt;:MATH:MEMory:STATe?

**Description**

Queries the status of the memory trace of the specified trace for the specified channel.

**Parameter**

Name	Type	Range	Default
<cn>	Integer	1 to 500	1
<mn>	Integer	1 to 50000	1

**Remarks**

N/A

**Return Format**

The query returns 0 (not stored) or 1 (have been stored).

**Example**

:CALCulate1:MEASure1:MATH:MEMory:STATe? /\*The query returns 1.\*/

**7.21.4 :CALCulate<cn>:MEASure<mn>:MATH:FUNCTion****Syntax**

:CALCulate&lt;cn&gt;:MEASure&lt;mn&gt;:MATH:FUNCTion &lt;type&gt;

:CALCulate<cn>:MEASure<mn>:MATH:FUNction?

### Description

Performs math operation on the data of the specified trace and trace data in the memory.

Queries the math operation type on the data of the specified trace and trace data in the memory.

### Parameter

Name	Type	Range	Default
<cn>	Integer	1 to 500	1
<mn>	Integer	1 to 50000	1
<type>	Discrete	{NORMal ADD SUBTract MULTiply DIVide}	NORMal

### Remarks

- NORMal: no math operation is performed on the current measurement data.
- ADD: Performs Data + Memory operation.
- SUBTract: Performs Data - Memory operation.
- MULTiply: Performs Data \* Memory operation.
- DIVide: Performs Data / Memory operation.

### Return Format

The query returns NORM, ADD, SUBT, MULT, or DIV.

### Example

```
:CALCulate1:MEASure1:MATH:FUNction ADD /*Adds data of measurement
trace 1 and the data in the memory.*/
:CALCulate1:MEASure1:MATH:FUNction? /*The query returns ADD.*/
```

## 7.22 :CALCulate<cn>:MEASure<mn>:GDElay Commands

The CALCulate<cn>:MEASure<mn>:GDElay commands are used to set and query the Group Delay function parameters.

Group delay is the time delay of the amplitude envelope of a signal as it passes through a device or network. It represents the rate of change of phase shift with respect to frequency, indicating how different frequency components within a signal experience different transmission delays through the device.

The group delay is a measure of phase distortion. It describes the transit time of a signal through a device versus frequency.

## 7.22.1 :CALCulate<cn>:MEASure<mn>:GDElay:PERCent

### Syntax

```
:CALCulate<cn>:MEASure<mn>:GDElay:PERCent <value>
```

```
:CALCulate<cn>:MEASure<mn>:GDElay:PERCent?
```

### Description

Sets the percent of span for the specified measurement trace.

Queries the percent of span for the specified measurement trace.

### Parameter

Name	Type	Range	Default
<cn>	Integer	1 to 500	1
<mn>	Integer	1 to 50000	1
<value>	Real	0% to 100%	5%

### Remarks

Only when the data format of the measurement trace is set to group delay (*:CALCulate<cn>:MEASure<mn>:FORMat*), can this command be valid.

With the sweep frequency range and sweep points (*:SENSe<cn>:SWEep:POINTs*) unchanged, changing any value among the percent of span, aperture points (*:CALCulate<cn>:MEASure<mn>:GDElay:POINTs*), and aperture frequency (*:CALCulate<cn>:MEASure<mn>:GDElay:FREQuency*) will affect the other two parameters.

### Return Format

The returns the percent of span in scientific notation. Its unit is %.

### Example

```
:CALCulate1:MEASure1:GDElay:PERCent 25 /*Sets the percent of span to 25%.*/
:CALCulate1:MEASure1:GDElay:PERCent? /*The query returns 2.50e+01.*/
```

## 7.22.2 :CALCulate<cn>:MEASure<mn>:GDElay:POINTs

### Syntax

```
:CALCulate<cn>:MEASure<mn>:GDElay:POINTs <value>
```

```
:CALCulate<cn>:MEASure<mn>:GDElay:POINTs?
```

**Description**

Sets the number of adjacent points to average in the group delay for the specified measurement trace.

Queries the number of adjacent points to average in the group delay for the specified measurement trace.

**Parameter**

Name	Type	Range	Default
<cn>	Integer	1 to 500	1
<mn>	Integer	1 to 50000	1
<value>	Integer	2 to 100001	11

**Remarks**

Only when the data format of the measurement trace is set to group delay (:CALCulate<cn>:MEASure<mn>:FORMat), can this command be valid.

With the sweep frequency range and sweep points (:SENSe<cn>:SWEep:POINTs) unchanged, changing any value among the percent of span (:CALCulate<cn>:MEASure<mn>:GDELay:PERCent), aperture points, and aperture frequency (:CALCulate<cn>:MEASure<mn>:GDELay:FREQuency) will affect the other two parameters.

**Return Format**

The query returns the number of adjacent points to average in the group delay in integer.

**Example**

```
:CALCulate1:MEASure1:GDELay:POINTs 20 /*Sets the number of adjacent
points to average in the group delay for the measurement trace 1 to
20.*/
:CALCulate1:MEASure1:GDELay:POINTs? /*The query returns 20.*/
```

**7.22.3 :CALCulate<cn>:MEASure<mn>:GDELay:FREQuency****Syntax**

```
:CALCulate<cn>:MEASure<mn>:GDELay:FREQuency <freq>
```

```
:CALCulate<cn>:MEASure<mn>:GDELay:FREQuency?
```

**Description**

Sets the group delay frequency for the specified measurement trace.

Queries the group delay frequency for the specified measurement trace.

**Parameter**

Name	Type	Range	Default
<cn>	Integer	1 to 500	1
<mn>	Integer	1 to 50000	1
<freq>	Real	0 Hz to 26.5 GHz	0 Hz

**Remarks**

Only when the data format of the measurement trace is set to group delay (:CALCulate<cn>:MEASure<mn>:FORMat), can this command be valid.

With the sweep frequency range and sweep points (:SENSe<cn>:SWEep:POINTs) unchanged, changing any value among the percent of span (:CALCulate<cn>:MEASure<mn>:GDELay:PERCent), aperture points, and aperture frequency (:CALCulate<cn>:MEASure<mn>:GDELay:POINTs) will affect the other two parameters.

The range of the <freq> parameter is related to the product model. For the product model, refer to product model table.

**Return Format**

The query returns the group delay frequency in scientific notation. Its unit is Hz.

**Example**

```
:CALCulate1:MEASure1:GDELay:FREQuency 1000 /*Sets the group delay
frequency for the measurement trace 1 to 1 kHz.*/
:CALCulate1:MEASure1:GDELay:FREQuency? /*The query returns 1.00e
+03.*/
```

## 7.23 :CALCulate<cn>:MEASure<mn>:FUNction Commands

:CALCulate<cn>:MEASure<mn>:FUNction commands are used to query the relevant data and statistics information of the measurement trace.

### 7.23.1 :CALCulate<cn>:MEASure<mn>:FUNction:STATistics[:STATe]

**Syntax**

```
:CALCulate<cn>:MEASure<mn>:FUNction:STATistics[:STATe] <bool>
```

```
:CALCulate<cn>:MEASure<mn>:FUNction:STATistics[:STATe]?
```

**Description**

Enables or disables the display of trace statistics for the specified measurement trace.  
 Queries whether to display the trace statistics for the specified measurement trace.

**Parameter**

Name	Type	Range	Default
<cn>	Integer	1 to 500	1
<mn>	Integer	1 to 50000	1
<bool>	Bool	{{1 ON}}{0 OFF}}	0 OFF

**Remarks**

- ON: displays the trace statistics.
- OFF: hides the trace statistics.

**Return Format**

The query returns 1 or 0.

**Example**

```
:CALCulate1:MEASure1:FUNCTION:STATISTICS ON /*Enables the display
of trace statistics for measurement trace 1.*/
:CALCulate1:MEASure1:FUNCTION:STATISTICS? /*The query returns 1.*/
```

**7.23.2 :CALCulate<cn>:MEASure<mn>:FUNCTION:TYPE****Syntax**

```
:CALCulate<cn>:MEASure<mn>:FUNCTION:TYPE <type>
:CALCulate<cn>:MEASure<mn>:FUNCTION:TYPE?
```

**Description**

Sets the trace statistics data type of the specified measurement trace.  
 Queries the trace statistics data type of the specified measurement trace.

**Parameter**

Name	Type	Range	Default
<cn>	Integer	1 to 500	1
<mn>	Integer	1 to 50000	1
<type>	Discrete	{PTPeak STDEV MEAN MIN MAX}	PTPeak

**Remarks**

- PTPeak: Peak to Peak. It indicates the difference between the max. and min. data points on the trace.
- STDEV: Standard deviation. It indicates standard deviation of all data points on the trace.
- MEAN: mean (average) of all data points on the trace.
- MIN: Lowest data points on the trace.
- MAX: Highest data points on the trace.

**Return Format**

The query returns PTP, STDEV, MEAN, MIN, or MAX.

**Example**

```
:CALCulate1:MEASure1:FUNCTion:TYPE MAX /*Sets the statistics type
of measurement trace 1 to MAX.*/
:CALCulate1:MEASure1:FUNCTion:TYPE? /*The query returns MAX.*/
```

### 7.23.3 :CALCulate<cn>:MEASure<mn>:FUNCTion:DATA?

**Syntax**

```
:CALCulate<cn>:MEASure<mn>:FUNCTion:DATA?
```

**Description**

Queries statistics data of the specified measurement trace.

**Parameter**

Name	Type	Range	Default
<cn>	Integer	1 to 500	1
<mn>	Integer	1 to 50000	1

**Remarks**

Related to the data format (*:CALCulate<cn>:MEASure<mn>:FORMat*) of the measurement trace and the statistics type (*:CALCulate<cn>:MEASure<mn>:FUNCTion:TYPE*).

**Return Format**

The query returns the statistics data of the specified measurement trace in scientific notation.

**Example**

```
:CALCulate1:MEASure1:FUNCTion:DATA? /*The query returns 8.81e+02.*/
```

## 7.23.4 :CALCulate<cn>:MEASure<mn>:FUNCTion:DOMain:USER[:RANGE]

**Syntax**

```
:CALCulate<cn>:MEASure<mn>:FUNCTion:DOMain:USER[:RANGE] <userid>
```

```
:CALCulate<cn>:MEASure<mn>:FUNCTion:DOMain:USER[:RANGE]?
```

**Description**

Sets the user domain of the specified measurement trace.

Queries the user domain of the specified measurement trace.

**Parameter**

Name	Type	Range	Default
<cn>	Integer	1 to 500	1
<mn>	Integer	1 to 50000	1
<userid>	Integer	0 to 16	0

**Remarks**

To set the start point of the X-axis, run

the *:CALCulate<cn>:MEASure<mn>:FUNCTion:DOMain:USER:START* command; to set the stop point of the X-axis, run

the *:CALCulate<cn>:MEASure<mn>:FUNCTion:DOMain:USER:STOP* command.

- When <userid> is set to 0, it indicates the full span. That is the whole X-axis.
- When <userid> is set to 1-16, it indicates the user defined span User 1 through User 16. Each channel has 16 user domains.

**Return Format**

The query returns the search domain in integer.

**Example**

```
:CALCulate1:MEASure1:FUNCTion:DOMain:USER 2 /*Sets the user domain of the measurement trace1 to User 2.*/
:CALCulate1:MEASure1:FUNCTion:DOMain:USER? /*The query returns 2.*/
```

## 7.23.5 :CALCulate<cn>:MEASure<mn>:FUNction:DOMain:USER:START

### Syntax

```
:CALCulate<cn>:MEASure<mn>:FUNction:DOMain:USER:START <range>,<start>
```

```
:CALCulate<cn>:MEASure<mn>:FUNction:DOMain:USER:START? <range>
```

### Description

Sets the domain start frequency of the user-defined search domain for the specified measurement trace.

Queries the domain start frequency of the user-defined search domain for the specified measurement trace.

### Parameter

Name	Type	Range	Default
<cn>	Integer	1 to 500	1
<mn>	Integer	1 to 50000	1
<range>	Integer	0 to 16	0
<start>	Real	Refer to Remarks	-

### Remarks

- When <range> is set to 0, it indicates the full span. That is the whole X-axis.
- When <range> is set to 1-16, it indicates the user defined span User 1 through User 16. Each channel has 16 user domains.

The unit of <start> is related to the sweep type.

This command functions the same as the `:CALCulate<cn>:MEASure<mn>:MARKer<mk>:FUNction:DOMain:USER:START` command.

### Return Format

The query returns the domain start frequency of the user-defined search domain in scientific notation. The unit is the same as that of the X-axis.

### Example

```
:CALCulate1:MEASure1:FUNction:DOMain:USER:START 1,2000 /*Sets the domain start frequency of User 1 to 2 kHz.*/
:CALCulate1:MEASure1:FUNction:DOMain:USER:START 1? /*The query returns 2.00e+03.*/
```

## 7.23.6 :CALCulate<cn>:MEASure<mn>:FUNction:DOMain:USER:STOP

### Syntax

```
:CALCulate<cn>:MEASure<mn>:FUNction:DOMain:USER:STOP <range>,<stop>
```

```
:CALCulate<cn>:MEASure<mn>:FUNction:DOMain:USER:STOP? <range>
```

### Description

Sets the domain stop frequency of the user-defined search domain for the specified measurement trace.

Queries the domain stop frequency of the user-defined search domain for the specified measurement trace.

### Parameter

Name	Type	Range	Default
<cn>	Integer	1 to 500	1
<mn>	Integer	1 to 50000	1
<range>	Integer	0 to 16	0
<stop>	Real	Refer to Remarks	-

### Remarks

- When <range> is set to 0, it indicates the full span. That is the whole X-axis.
- When <range> is set to 1-16, it indicates the user defined span User 1 through User 16. Each channel has 16 user domains.

The unit of <stop> is related to the sweep type.

This command functions the same as the `:CALCulate<cn>:MEASure<mn>:MARKer<mk>:FUNction:DOMain:USER:STOP` command.

### Return Format

The query returns the domain stop frequency of the user-defined search domain in scientific notation.

### Example

```
:CALCulate1:MEASure1:FUNction:DOMain:USER:STOP 1,2000 /*Sets the domain stop frequency of the user-defined search domain 1 to 2 kHz.*/
```

```
:CALCulate1:MEASure1:FUNction:DOMain:USER:STOP 1? /*The query
returns 2.00e+03.*/
```

## 7.24 :CALCulate<cn>:MEASure<mn>:MARKer Commands

The :CALCulate<cn>:MEASure<mn>:MARKer<mk> are used to set and query the Marker function parameters.

Wherein, <mk> indicates the existing marker number.

### 7.24.1 :CALCulate<cn>:MEASure<mn>:MARKer:AOFF

#### Syntax

```
:CALCulate<cn>:MEASure<mn>:MARKer:AOFF
```

#### Description

Disables all the markers for the specified measurement trace.

#### Parameter

Name	Type	Range	Default
<cn>	Integer	1 to 500	1
<mn>	Integer	1 to 50000	1

#### Remarks

N/A

#### Return Format

N/A

#### Example

N/A

### 7.24.2 :CALCulate<cn>:MEASure<mn>:MARKer<mk>[:STATe]

#### Syntax

```
:CALCulate<cn>:MEASure<mn>:MARKer<mk>[:STATe]<bool>
```

```
:CALCulate<cn>:MEASure<mn>:MARKer<mk>[:STATe]?
```

#### Description

Enables or disables the specified marker.

Queries the on/off status of the specified marker.

**Parameter**

Name	Type	Range	Default
<cn>	Integer	1 to 500	1
<mn>	Integer	1 to 50000	1
<mk>	Integer	1 to 16	1
<bool>	Bool	{{1 ON}}{0 OFF}}	0 OFF

**Remarks**

N/A

**Return Format**

The query returns 1 or 0.

**Example**

```
:CALCulate1:MEASure1:MARKer1 ON /*Enables Marker1.*/
:CALCulate1:MEASure1:MARKer1? /*The query returns 1.*/
```

### 7.24.3 :CALCulate<cn>:MEASure<mn>:MARKer<mk>:COUPling[:STATE]

**Syntax**

```
:CALCulate<cn>:MEASure<mn>:MARKer<mk>:COUPling[:STATE] <bool>
```

```
:CALCulate<cn>:MEASure<mn>:MARKer<mk>:COUPling[:STATE]?
```

**Description**

Enables or disables the coupled markers for the specified measurement trace.

Queries the on/off status of the coupled markers for the specified measurement trace.

**Parameter**

Name	Type	Range	Default
<cn>	Integer	1 to 500	1
<mn>	Integer	1 to 50000	1
<mk>	Integer	1 to 16	1
<bool>	Bool	{{1 ON}}{0 OFF}}	0 OFF

**Remarks**

To set the scope of the coupled markers, run the `:CALCulate<cn>:MEASure<mn>:MARKer<mk>:COUPling:METHOD` command.

**Return Format**

The query returns 1 or 0.

**Example**

```
:CALCulate1:MEASure1:MARKer1:COUPling ON /*Enables coupled markers.*/
:CALCulate1:MEASure1:MARKer1:COUPling? /*The query returns 1.*/
```

## 7.24.4 :CALCulate<cn>:MEASure<mn>:MARKer<mk>:COUPling:METHOD

**Syntax**

```
:CALCulate<cn>:MEASure<mn>:MARKer<mk>:COUPling:METHOD <type>
:CALCulate<cn>:MEASure<mn>:MARKer<mk>:COUPling:METHOD?
```

**Description**

Sets the scope of the coupled markers for the specified measurement trace.

Queries the scope of the coupled markers for the specified measurement trace.

**Parameter**

Name	Type	Range	Default
<cn>	Integer	1 to 500	1
<mn>	Integer	1 to 50000	1
<mk>	Integer	1 to 16	1
<type>	Discrete	{ALL CHANnel}	ALL

**Remarks**

This command is only valid when you have set the `:CALCulate<cn>:MEASure<mn>:MARKer<mk>:COUPling[:STATe]` command to ON.

- CHANnel: coupling is only limited to traces in the same channel.
- ALL: Coupling occurs across all channels.

The parameter <mk> does not function in the command. In this command, the coupling setting is global to all the markers of the measurement trace.

**Return Format**

The query returns ALL or CHAN.

**Example**

```
:CALCulate1:MEASure1:MARKer1:COUpling CHANnel /*Sets the scope of
the coupled marker to CHANnel.*/
:CALCulate1:MEASure1:MARKer1:COUpling? /*The query returns CHAN.*/
```

**7.24.5 :CALCulate<cn>:MEASure<mn>:MARKer<mk>:DELTA****Syntax**

```
:CALCulate<cn>:MEASure<mn>:MARKer<mk>:DELTA <bool>
```

```
:CALCulate<cn>:MEASure<mn>:MARKer<mk>:DELTA?
```

**Description**

Specifies whether the specified marker is relative to Reference marker or absolute.

Queries whether the specified marker is relative to Reference marker or absolute.

**Parameter**

Name	Type	Range	Default
<cn>	Integer	1 to 500	1
<mn>	Integer	1 to 50000	1
<mk>	Integer	1 to 16	1
<bool>	Bool	{{1 ON}}{0 OFF}}	0 OFF

**Remarks**

- ON (or 1): the specified marker is a Delta marker.
- OFF (or 0): the specified marker is an Absolute marker.

**Return Format**

The query returns 1 or 0.

**Example**

```
:CALCulate1:MEASure1:MARKer1:DELTA ON /*Sets Marker1 to Delta
marker.*/
:CALCulate1:MEASure1:MARKer1:DELTA? /*The query returns 1.*/
```

## 7.24.6 :CALCulate<cn>:MEASure<mn>:MARKer<mk>:DISCcrete

### Syntax

```
:CALCulate<cn>:MEASure<mn>:MARKer<mk>:DISCcrete <bool>
:CALCulate<cn>:MEASure<mn>:MARKer<mk>:DISCcrete?
```

### Description

Sets the specified marker to display either a calculated value between data points (interpolated data) or the actual data points (discrete data).

Queries the specified marker to display either a calculated value between data points (interpolated data) or the actual data points (discrete data).

### Parameter

Name	Type	Range	Default
<cn>	Integer	1 to 500	1
<mn>	Integer	1 to 50000	1
<mk>	Integer	1 to 16	1
<bool>	Bool	{{1 ON}}{0 OFF}}	0 OFF

### Remarks

- ON|1: Sets the specified marker to display the actual data points.
- OFF|0: sets the specified marker to display calculated value between the actual data points.

### Return Format

The query returns 1 or 0.

### Example

```
:CALCulate1:MEASure1:MARKer1:DISCcrete ON /*Sets Marker 1 to display
the actual data points.*/
:CALCulate1:MEASure1:MARKer1:DISCcrete? /*The query returns 1.*/
```

## 7.24.7 :CALCulate<cn>:MEASure<mn>:MARKer<mk>:FORMat

### Syntax

```
:CALCulate<cn>:MEASure<mn>:MARKer<mk>:FORMat <type>
:CALCulate<cn>:MEASure<mn>:MARKer<mk>:FORMat?
```

**Description**

Sets the data format type of the specified marker of the specified channel.

Queries the data format type of the specified marker of the specified channel.

**Parameter**

Name	Type	Range	Default
<cn>	Integer	1 to 500	1
<mn>	Integer	1 to 50000	1
<mk>	Integer	1 to 16	1
<type>	Discrete	{DEFault MLINear MLOGarithmic PHASe GDELay REAL IMAGinary SWR LINPhase LOGPhase POLar IMPedance ADMittance}	DEFault

**Remarks**

- DEFault: indicates Trace Default.
- MLINear: indicates Linear magnitude.
- MLOGarithmic: indicates Log magnitude.
- PHASe: indicates phase.
- GDELay: indicates group delay.
- REAL: indicates Real.
- IMAGinary: indicates Imaginary.
- SWR: indicates standing wave ratio (SWR).
- LINPhase: indicates Lin/Phase.
- LOGPhase: indicates Log/Phase.
- POLar: indicates Real/Imaginary format.
- IMPedance: indicates R+jX.
- ADMittance: indicates G+jB.

**Return Format**

The query returns DEF, MLIN, MLOG, PHAS, GDEL, REAL, IMAG, SWR, LINP, LOGP, POL, IMP, or ADM.

**Example**

```
:CALCulate1:MEASure1:MARKer1:FORMat MLINear /*Sets data format of
Marker 1 to MLINear.*/
:CALCulate1:MEASure1:MARKer1:FORMat? /*The query returns MLIN.*/
```

**7.24.8 :CALCulate<cn>:MEASure<mn>:MARKer<mk>:TYPE****Syntax**

```
:CALCulate<cn>:MEASure<mn>:MARKer<mk>:TYPE <type>
:CALCulate<cn>:MEASure<mn>:MARKer<mk>:TYPE?
```

**Description**

Sets the type of the specified marker.

Queries the type of the specified marker.

**Parameter**

Name	Type	Range	Default
<cn>	Integer	1 to 500	1
<mn>	Integer	1 to 50000	1
<mk>	Integer	1 to 16	1
<type>	Discrete	{NORMAL FIXed}	NORMAL

**Remarks**

- NORMAL: a marker that stays on the assigned X-axis position unless removed or searching.
- FIXed: a marker that will not leave the assigned X or current Y-axis position. It will not move with the update of the trace data.

**Return Format**

The query returns NORM or FIX.

**Example**

```
:CALCulate1:MEASure1:MARKer1:TYPE FIXed /*Sets Marker1 to FIXed
type.*/
:CALCulate1:MEASure1:MARKer1:TYPE? /*The query returns 1.*/
```

## 7.24.9 :CALCulate<cn>:MEASure<mn>:MARKer<mk>:X

### Syntax

```
:CALCulate<cn>:MEASure<mn>:MARKer<mk>:X <value>
```

```
:CALCulate<cn>:MEASure<mn>:MARKer<mk>:X?
```

### Description

Setup the X-axis value of the specified marker.

Queries the X-axis value of the specified marker.

### Parameter

Name	Type	Range	Default
<cn>	Integer	1 to 500	1
<mn>	Integer	1 to 50000	1
<mk>	Integer	1 to 16	1
<value>	Real	Refer to Remarks	0

### Remarks

X-axis can represent frequency or power. If the marker is set to Delta marker (`:CALCulate<cn>:MEASure<mn>:MARKer<mk>:DELTA`), then the data set and queried are relative to the reference marker.

The parameter <value> indicates any X-axis position within the measurement span of the marker. Its unit is related to the sweep type.

### Return Format

The query returns the X-axis value of the specified marker in scientific notation. The unit is Hz or dBm.

### Example

```
:CALCulate1:MEASure1:MARKer1:X -10 /*Sets the X-axis value for
Marker1 to -10 dBm.*/
:CALCulate1:MEASure1:MARKer1:X? /*The query returns -1.00e+01.*/
```

## 7.24.10 :CALCulate<cn>:MEASure<mn>:MARKer<mk>:Y?

### Syntax

```
:CALCulate<cn>:MEASure<mn>:MARKer<mk>:Y?
```

### Description

Queries the Y-axis value of the specified marker.

**Parameter**

Name	Type	Range	Default
<cn>	Integer	1 to 500	1
<mn>	Integer	1 to 50000	1
<mk>	Integer	1 to 16	1

**Remarks**

If the marker is set to Delta marker

(*:CALCulate<cn>:MEASure<mn>:MARKer<mk>:DELTA*), then the data set and queried are relative to the reference marker.

The return format is determined by the settings specified by the *:CALCulate<cn>:MEASure<mn>:FORMat* command.

The query always returns two numbers:

- For Smith and Polar format, the query returns in (real, imaginary) format.
- For linear phase and log phase, the query returns in (real, imaginary) format.
- For other formats, the query returns in (return value, 0) format.

If you have applied the smoothing function

(*:CALCulate<cn>:MEASure<mn>:SMOothing[:STATE]*), to read the Y-axis value of the marker properly, the queried marker format must be consistent with the displayed format of measurement (*:CALCulate<cn>:MEASure<mn>:FORMat*). Otherwise, the returned values are data not having been smoothed. For example, when reading the value for smoothing in group delay format, the display format and the marker format must be set to group delay.

**Return Format**

The query returns the Y-axis value of the specified marker in strings.

**Example**

```
:CALCulate1:MEASure1:MARKer1:Y? /*The query returns -6.28006525289E+01,+0.000000000000E+00.*/
```

## 7.24.11 :CALCulate<cn>:MEASure<mn>:MARKer<mk>:FUNCTION:EXECute

**Syntax**

```
:CALCulate<cn>:MEASure<mn>:MARKer<mk>:FUNCTION:EXECute <type>
```

**Description**

Sets the specified marker on the specified trace of the specified channel to perform the specified type of search.

**Parameter**

Name	Type	Range	Default
<cn>	Integer	1 to 500	1
<mn>	Integer	1 to 50000	1
<mk>	Integer	1 to 16	1
<type>	Discrete	{MAXimum MINimum RPEak LPEak NPEak TARGet LTARget RTARget PEAK}	MAXimum

**Remarks**

- MAXimum: searches for the maximum value on the trace.
- MINimum: searches for the minimum value on the trace.
- RPEak: searches for the next valid peak to the right.
- LPEak: searches for the next valid peak to the left.
- NPEak: searches for the next highest value among the valid peaks.
- TARGet: searches for the target value to the right, wraps around to the left.
- LTARget: searches for the next target value to the left of the marker.
- RTARget: searches for the next target value to the right of the marker.
- PEAK: searches for the highest value among the valid peaks.

**Return Format**

N/A

**Example**

```
:CALCulate1:MEASure1:MARKer1:FUNction:EXECute PEAK /*Sets Marker 1
on Trace 1 of Channel 1 to perform the peak search.*/
```

## 7.24.12 :CALCulate<cn>:MEASure<mn>:MARKer<mk>:FUNction[:SElect]

**Syntax**

```
:CALCulate<cn>:MEASure<mn>:MARKer<mk>:FUNction[:SElect] <type>
```

:CALCulate<cn> :MEASure<mn> :MARKer<mk> :FUNCTion[:SElect]?

### Description

Sets the search function that the specified marker will perform.

Queries the search function that the specified marker will perform.

### Parameter

Name	Type	Range	Default
<cn>	Integer	1 to 500	1
<mn>	Integer	1 to 50000	1
<mk>	Integer	1 to 16	1
<type>	Discrete	{MAXimum MINimum RPEak LPEak NPEak TARGet LTARget RTARget PEAK}	MAXimum

### Remarks

- MAXimum: searches for the maximum value on the trace.
- MINimum: searches for the minimum value on the trace.
- RPEak: searches for the next valid peak to the right.
- LPEak: searches for the next valid peak to the left.
- NPEak: searches for the next highest value among the valid peaks.
- TARGet: searches for the target value to the right, wraps around to the left.
- LTARget: searches for the next target value to the left of the marker.
- RTARget: searches for the next target value to the right of the marker.
- PEAK: searches for the highest value among the valid peaks.

If you set the `:CALCulate<cn>:MEASure<mn>:MARKer<mk>:FUNCTion:TRACking` command to ON, then the search operation is performed automatically when each sweep is initiated.

### Return Format

The query returns MAX, MIN, RPE, LPE, NPE, TARG, LTAR, RTAR, or PEAK.

### Example

```
:CALCulate1:MEASure1:MARKer1:FUNCTion MINimum /*Sets the Marker1 to
search for the minimum value on the trace.*/
:CALCulate1:MEASure1:MARKer1:FUNCTion? /*The query returns MIN.*/
```

## 7.24.13 :CALCulate<cn>:MEASure<mn>:MARKer<mk>:FUNctioN:TRACking

### Syntax

```
:CALCulate<cn>:MEASure<mn>:MARKer<mk>:FUNctioN:TRACking <bool>
```

```
:CALCulate<cn>:MEASure<mn>:MARKer<mk>:FUNctioN:TRACking?
```

### Description

Enables or disables the search tracking function of the specified marker.

Queries the on/off state of the search tracking function of the specified marker.

### Parameter

Name	Type	Range	Default
<cn>	Integer	1 to 500	1
<mn>	Integer	1 to 50000	1
<mk>	Integer	1 to 16	1
<bool>	Bool	{{1 ON}} {{0 OFF}}	0 OFF

### Remarks

When you enable the search tracking function, it functions the same as running the `:CALCulate<cn>:MEASure<mn>:MARKer<mk>:FUNctioN:EXECute` command for each sweep.

### Return Format

The query returns 1 or 0.

### Example

```
:CALCulate1:MEASure1:MARKer1:FUNctioN:TRACking ON /*Enables the
search tracking of Marker 1.*/
:CALCulate1:MEASure1:MARKer1:FUNctioN:TRACking? /*The query returns
1.*/
```

## 7.24.14 :CALCulate<cn>:MEASure<mn>:MARKer<mk>:FUNctioN:DOMain:USER[:RANGe]

### Syntax

```
:CALCulate<cn>:MEASure<mn>:MARKer<mk>:FUNctioN:DOMain:USER[:RANGe]
<userid>
```

```
:CALCulate<cn>:MEASure<mn>:MARKer<mk>:FUNction:DOMain:USER[:RANGe]
?
```

### Description

Assigns the specified marker to a specified range number.

Queries the range number assigned to the specified marker.

### Parameter

Name	Type	Range	Default
<cn>	Integer	1 to 500	1
<mn>	Integer	1 to 50000	1
<mk>	Integer	1 to 16	1
<userid>	Integer	0 to 16	0

### Remarks

This command defines the marker on the trace to search within the specified span.

- When <userid> is set to 0, it indicates the full span. That is the whole X-axis.
- When <userid> is set to 1-16, it indicates the user defined range number searched by the marker. It is User 1 through User 16.

To set the start point of the X-axis, run

the `:CALCulate<cn>:MEASure<mn>:MARKer<mk>:FUNction:DOMain:USER:START`

command; to set the stop point of the X-axis, run

the `:CALCulate<cn>:MEASure<mn>:MARKer<mk>:FUNction:DOMain:USER:STOP` command.

### Return Format

The query returns the search domain in integer.

### Example

```
:CALCulate1:MEASure1:MARKer1:FUNction:DOMain:USER 2 /*Assigns the
search range number for Marker1 to 2.*/
:CALCulate1:MEASure1:MARKer1:FUNction:DOMain:USER? /*The query
returns 2.*/
```

## 7.24.15 :CALCulate<cn>:MEASure<mn>:MARKer<mk>:FUNction:DOMain:USER:START

### Syntax

```
:CALCulate<cn>:MEASure<mn>:MARKer<mk>:FUNction:DOMain:USER:START
<value>
```

```
:CALCulate<cn>:MEASure<mn>:MARKer<mk>:FUNction:DOMain:USER:START?
```

### Description

Sets the start point of the X-axis of the user domain for the specified marker.

Queries the start point of the X-axis of the user domain for the specified marker.

### Parameter

Name	Type	Range	Default
<cn>	Integer	1 to 500	1
<mn>	Integer	1 to 50000	1
<mk>	Integer	1 to 16	1
<value>	Real	Refer to Remarks	-

### Remarks

Before performing this command to set the start point of the X-axis of the user domain, run

the `:CALCulate<cn>:MEASure<mn>:MARKer<mk>:FUNction:DOMain:USER[:RANGe]` command first to set the user domain No.

The unit of <value> is related to the sweep type.

### Return Format

The query returns the start point of the X-axis of the user domain for the specified marker in scientific notation.

### Example

```
:CALCulate1:MEASure1:MARKer1:FUNction:DOMain:USER:START 10 /*Sets
the start point of the X-axis of the user domain to 10 Hz.*/
:CALCulate1:MEASure1:MARKer1:FUNction:DOMain:USER:START?
/*The query returns 1.00e+01.*/
```

## 7.24.16 :CALCulate<cn>:MEASure<mn>:MARKer<mk>:FUNCTion:DOMain:USER:STOP

### Syntax

```
:CALCulate<cn>:MEASure<mn>:MARKer<mk>:FUNCTion:DOMain:USER:STOP
<value>
```

```
:CALCulate<cn>:MEASure<mn>:MARKer<mk>:FUNCTion:DOMain:USER:STOP?
```

### Description

Sets the stop value of the frequency sweep or the stop point of the X-axis of the user domain for the specified marker.

Queries the stop value of the frequency sweep or the stop point of the X-axis of the user domain for the specified marker.

### Parameter

Name	Type	Range	Default
<cn>	Integer	1 to 500	1
<mn>	Integer	1 to 50000	1
<mk>	Integer	1 to 16	1
<value>	Real	Refer to Remarks	-

### Remarks

Before performing this command to set the stop value of the frequency sweep or the stop point of the X-axis, run

the `:CALCulate<cn>:MEASure<mn>:MARKer<mk>:FUNCTion:DOMain:USER[:RANGe]` command first to set the user domain No.

The unit of <value> is related to the sweep type.

### Return Format

The query returns the stop value of the frequency sweep or the stop point of the X-axis of the user domain for the specified marker in scientific notation.

### Example

```
:CALCulate1:MEASure1:MARKer1:FUNCTion:DOMain:USER:STOP 2000 /*Sets
the stop frequency of the X-axis of the user domain for Marker1 to
2 kHz.*/
:CALCulate1:MEASure1:MARKer1:FUNCTion:DOMain:USER:STOP? /*The query
returns 2.00e+03.*/
```

## 7.24.17 :CALCulate<cn>:MEASure<mn>:MARKer<mk>:FUNction:PEAK:EXCursion

### Syntax

```
:CALCulate<cn>:MEASure<mn>:MARKer<mk>:FUNction:PEAK:EXCursion
<value>
```

```
:CALCulate<cn>:MEASure<mn>:MARKer<mk>:FUNction:PEAK:EXCursion?
```

### Description

Sets the peak excursion in the peak search of the specified marker.

Queries the peak excursion in the peak search of the specified marker.

### Parameter

Name	Type	Range	Default
<cn>	Integer	1 to 500	1
<mn>	Integer	1 to 50000	1
<mk>	Integer	1 to 16	1
<value>	Real	0 to 500	-

### Remarks

This command defines the criteria for searching the peak of the marker. The excursion value determines what is considered as a peak. This command applies to marker peak searches (Next Peak Search, Peak Right Search, and Peak Left Search).

The unit of <value> varies with the current data format (*:CALCulate<cn>:MEASure<mn>:FORMat*) of the trace.

- For MLOGarithmic (Log Mag) format, its unit is dB.
- For PHase (Phase), UPHase (Unwrapped Phase), or PPHase (Positive Phase) format, its unit is degree (°).
- For GDElay (group delay) format, its unit is s.
- For other format, it is unitless.

### Return Format

The query returns the peak excursion in scientific notation. Its unit is the same as that of the Y-axis.

**Example**

```
:CALCulate1:MEASure1:MARKer1:FUNction:PEAK:EXCursion 10 /*Sets the
peak excursion to 10 dB.*/
:CALCulate1:MEASure1:MARKer1:FUNction:PEAK:EXCursion? /
*The query returns 1.00e+1.*/
```

## 7.24.18 :CALCulate<cn>:MEASure<mn>:MARKer<mk>:FUNction:PEAK:POLarity

**Syntax**

```
:CALCulate<cn>:MEASure<mn>:MARKer<mk>:FUNction:PEAK:POLarity
<bool>
```

```
:CALCulate<cn>:MEASure<mn>:MARKer<mk>:FUNction:PEAK:POLarity?
```

**Description**

Sets the peak polarity in the peak search of the specified marker.

Queries the peak polarity in the peak search of the specified marker.

**Parameter**

Name	Type	Range	Default
<cn>	Integer	1 to 500	1
<mn>	Integer	1 to 50000	1
<mk>	Integer	1 to 16	1
<type>	Discrete	{NEGative POSitive BOTH}	POSitive

**Remarks**

NEGative: indicates the negative peak.

POSitive: indicates the positive peak.

BOTH: indicates both positive peak and negative peak are considered as valid peaks.

**Return Format**

The query returns NEG, POS, or BOTH.

**Example**

```
:CALCulate1:MEASure1:MARKer1:FUNction:PEAK:POLarity BOTH /*Sets the
peak polarity to BOTH.*/
:CALCulate1:MEASure1:MARKer1:FUNction:PEAK:POLarity? /*The query
returns BOTH.*/
```

## 7.24.19 :CALCulate<cn>:MEASure<mn>:MARKer<mk>:FUNction:PEAK:THReshold

### Syntax

```
:CALCulate<cn>:MEASure<mn>:MARKer<mk>:FUNction:PEAK:THReshold
<value>
```

```
:CALCulate<cn>:MEASure<mn>:MARKer<mk>:FUNction:PEAK:THReshold?
```

### Description

Sets the peak threshold in the peak search for the specified marker.

Queries the peak threshold in the peak search for the specified marker.

### Parameter

Name	Type	Range	Default
<cn>	Integer	1 to 500	1
<mn>	Integer	1 to 50000	1
<mk>	Integer	1 to 16	1
<value>	Real	-500 to 500	-100

### Remarks

If the polarity of the peak search is Positive, then peaks below the threshold will not be identified. If the polarity of the peak search is Negative, then peaks above the threshold will not be identified. If the polarity of the peak search is BOTH, this command is not valid.

### Return Format

The query returns the peak threshold in scientific notation. Its unit is the same as that of the Y-axis.

### Example

```
:CALCulate1:MEASure1:MARKer1:FUNction:PEAK:THReshold 10 /*Sets the
peak threshold value to 10 dB.*/
:CALCulate1:MEASure1:MARKer1:FUNction:PEAK:THReshold?           /
*The query returns 1.00e+01.*/
```

## 7.24.20 :CALCulate<cn>:MEASure<mn>:MARKer<mk>:FUNction:TARGET[:VALue]

### Syntax

```
:CALCulate<cn>:MEASure<mn>:MARKer<mk>:FUNction:TARGET[:VALue]
<value>
```

```
:CALCulate<cn>:MEASure<mn>:MARKer<mk>:FUNction:TARGET[:VALue]?
```

### Description

Sets the target value in the target search for the specified marker.

Queries the target value in the target search for the specified marker.

### Parameter

Name	Type	Range	Default
<cn>	Integer	1 to 500	1
<mn>	Integer	1 to 50000	1
<mk>	Integer	1 to 16	1
<value>	Real	-1E15 to 1E15	0

### Remarks

The unit of <value> varies with the current data format (:CALCulate<cn>:MEASure<mn>:MARKer<mk>:FORMat) of the trace.

- For MLOGarithmic (Log Mag) format, its unit is dB.
- For PHase (Phase), UPHase (Unwrapped Phase), or PPHase (Positive Phase) format, its unit is degree (°).
- For GDElay (group delay) format, its unit is s.
- For other format, it is unitless.

### Return Format

The query returns the target value for target search in scientific notation. Its unit is the same as that of the Y-axis.

### Example

```
:CALCulate1:MEASure1:MARKer1:FUNction:TARGET -10dB /*Sets the
target value in the target search to -10 dB.*/
:CALCulate1:MEASure1:MARKer1:FUNction:TARGET? /*The
query returns -1.00e+01.*/
```

## 7.24.21 :CALCulate<cn>:MEASure<mn>:MARKer<mk>:FUNctioN:TARGet:TRANsition

### Syntax

```
:CALCulate<cn>:MEASure<mn>:MARKer<mk>:FUNctioN:TARGet:TRANsition
<type>
```

```
:CALCulate<cn>:MEASure<mn>:MARKer<mk>:FUNctioN:TARGet:TRANsition?
```

### Description

Sets the target transition type in the target search of the specified marker.

Queries the target transition type in the target search of the specified marker.

### Parameter

Name	Type	Range	Default
<cn>	Integer	1 to 500	1
<mn>	Integer	1 to 50000	1
<mk>	Integer	1 to 16	1
<type>	Discrete	{NEGative POSitive BOTH}	BOTH

### Remarks

It is used to identify the transition type of the signal when the marker is performing the target search. It can be set to Positive, Negative, and Both.

### Return Format

The query returns NEG, POS, or BOTH.

### Example

```
:CALCulate1:MEASure1:MARKer1:FUNctioN:TARGet:TRANsition BOTH /*Sets
the target transition type for the target search to BOTH.*/
:CALCulate1:MEASure1:MARKer1:FUNctioN:TARGet:TRANsition? /
*The query returns BOTH.*/
```

## 7.24.22 :CALCulate<cn>:MEASure<mn>:MARKer<mk>:FUNctioN:MULTi:PEAK:EXCursion

### Syntax

```
:CALCulate<cn>:MEASure<mn>:MARKer<mk>:FUNctioN:MULTi:PEAK:EXCursio
n <value>
```

:CALCulate<cn>:MEASure<mn>:MARKer<mk>:FUNctioN:PEAK:EXCursioN?

### Description

Sets the multi peak excursion in the multi peak search of the specified marker.

Queries the multi peak excursion in the multi peak search of the specified marker.

### Parameter

Name	Type	Range	Default
<cn>	Integer	1 to 500	1
<mn>	Integer	1 to 50000	1
<mk>	Integer	1 to 16	1
<value>	Real	0 to 500	0

### Remarks

The unit of <value> varies with the current data format (:CALCulate<cn>:MEASure<mn>:FORMat) of the trace.

- For MLOGarithmic (Log Mag) format, its unit is dB.
- For PHase (Phase), UPHase (Unwrapped Phase), or PPHase (Positive Phase) format, its unit is degree (°).
- For GDElay (group delay) format, its unit is s.
- For other format, it is unitless.

### Return Format

The query returns the multi peak excursion in scientific notation. Its unit is the same as that of the Y-axis.

### Example

```
:CALCulate1:MEASure1:MARKer1:FUNctioN:PEAK:EXCursion 10 /*Sets the
multi peak excursion to 10 dB.*/
:CALCulate1:MEASure1:MARKer1:FUNctioN:PEAK:EXCursion? /
*The query returns 1.00e+01.*/
```

## 7.24.23 :CALCulate<cn>:MEASure<mn>:MARKer<mk>:FUNction:MULTi:PEAK:POLarity

### Syntax

```
:CALCulate<cn>:MEASure<mn>:MARKer<mk>:FUNction:MULTi:PEAK:POLarity <bool>
```

```
:CALCulate<cn>:MEASure<mn>:MARKer<mk>:FUNction:MULTi:PEAK:POLarity ?
```

### Description

Sets the multi peak polarity in the multi peak search of the specified marker.

Queries the multi peak polarity in the multi peak search of the specified marker.

### Parameter

Name	Type	Range	Default
<cn>	Integer	1 to 500	1
<mn>	Integer	1 to 50000	1
<mk>	Integer	1 to 16	1
<type>	Discrete	{NEGative POSitive BOTH}	POSitive

### Remarks

NEGative: indicates the negative peak.

POSitive: indicates the positive peak.

BOTH: indicates both positive peak and negative peak are considered as valid peaks.

### Return Format

The query returns NEG, POS, or BOTH.

### Example

```
:CALCulate1:MEASure1:MARKer1:FUNction:MULTi:PEAK:POLarity BOTH /
*Sets the multi peak polarity to BOTH.* /
:CALCulate1:MEASure1:MARKer1:FUNction:MULTi:PEAK:POLarity? /*The
query returns BOTH.* /
```

## 7.24.24 :CALCulate<cn>:MEASure<mn>:MARKer<mk>:FUNction:MULTi:PEAK:THReshold

### Syntax

```
:CALCulate<cn>:MEASure<mn>:MARKer<mk>:FUNction:MULTi:PEAK:THReshold <value>
```

```
:CALCulate<cn>:MEASure<mn>:MARKer<mk>:FUNction:MULTi:PEAK:THReshold?
```

### Description

Sets the multi peak threshold value in multi peak search for the specified marker.

Queries the multi peak threshold value in multi peak search for the specified marker.

### Parameter

Name	Type	Range	Default
<cn>	Integer	1 to 500	1
<mn>	Integer	1 to 50000	1
<mk>	Integer	1 to 16	1
<value>	Real	Refer to Remarks	-

### Remarks

If the polarity of the peak search is Positive, then peaks below the threshold will not be identified. If the polarity of the peak search is Negative, then peaks above the threshold will not be identified. If the polarity of the peak search is BOTH, this command is not valid.

### Return Format

The query returns the multi peak threshold in scientific notation. Its unit is the same as that of the Y-axis.

### Example

```
:CALCulate1:MEASure1:MARKer1:FUNction:MULTi:PEAK:THReshold 10 /
*Sets the multi peak threshold value to 10 dB.*
:CALCulate1:MEASure1:MARKer1:FUNction:MULTi:PEAK:THReshold?
/*The query returns 1.00e+01.*
```

## 7.24.25 :CALCulate<cn>:MEASure<mn>:MARKer<mk>:FUNction:MULTi:TARGet[:VALue]

### Syntax

```
:CALCulate<cn>:MEASure<mn>:MARKer<mk>:FUNction:MULTi:TARGet[:VALue] <value>
```

```
:CALCulate<cn>:MEASure<mn>:MARKer<mk>:FUNction:MULTi:TARGet[:VALue]?
```

### Description

Sets the multi target value in the multi peak and target search for the specified marker.

Queries the multi target value in the multi peak and target search for the specified marker.

### Parameter

Name	Type	Range	Default
<cn>	Integer	1 to 500	1
<mn>	Integer	1 to 50000	1
<mk>	Integer	1 to 16	1
<value>	Real	-1E15 to 1E15	0

### Remarks

The unit of <value> varies with the current data format (:CALCulate<cn>:MEASure<mn>:FORMat) of the trace.

- For MLOGarithmic (Log Mag) format, its unit is dB.
- For PHase (Phase), UPHase (Unwrapped Phase), or PPHase (Positive Phase) format, its unit is degree (°).
- For GDElay (group delay) format, its unit is s.
- For other format, it is unitless.

### Return Format

The query returns the multi target value for the multi peak and target search in scientific notation. Its unit is the same as that of the Y-axis.

**Example**

```
:CALCulate1:MEASure1:MARKer1:FUNCTion:MULTi:TARGet -10 /*Sets
the multi target value to -10 dB.*/
:CALCulate1:MEASure1:MARKer1:FUNCTion:MULTi:TARGet?
/*The query returns -1.00e+01.*/
```

## 7.24.26 :CALCulate<cn>:MEASure<mn>:MARKer<mk>:FUNCTion:MULTi:TARGet:TRANSition

**Syntax**

```
:CALCulate<cn>:MEASure<mn>:MARKer<mk>:FUNCTion:MULTi:TARGet:TRANSi
tion <type>
```

```
:CALCulate<cn>:MEASure<mn>:MARKer<mk>:FUNCTion:MULTi:TARGet:TRANSi
tion?
```

**Description**

Sets the multi target transition type in the multi target search of the specified marker.

Queries the multi target transition type in the multi target search of the specified marker.

**Parameter**

Name	Type	Range	Default
<cn>	Integer	1 to 500	1
<mn>	Integer	1 to 50000	1
<mk>	Integer	1 to 16	1
<type>	Discrete	{NEGative POSitive BOTH}	BOTH

**Remarks**

It is used to identify the transition type of the signal when the marker is performing the multi target search. It can be set to Positive, Negative, and Both.

**Return Format**

The query returns NEG, POS, or BOTH.

**Example**

```
:CALCulate1:MEASure1:MARKer1:FUNCTion:MULTi:TARGet:TRANSition
BOTH /*Sets the transition type for multi target search to
BOTH.*/
:CALCulate1:MEASure1:MARKer1:FUNCTion:MULTi:TARGet:TRANSition?
/*The query returns BOTH.*/
```

## 7.24.27 :CALCulate<cn>:MEASure<mn>:MARKer<mk>:FUNction:MULTi:EXECute

### Syntax

```
:CALCulate<cn>:MEASure<mn>:MARKer<mk>:FUNction:MULTi:EXECute
<type>
```

### Description

Executes the Multi Peak & Target operation.

### Parameter

Name	Type	Range	Default
<cn>	Integer	1 to 500	1
<mn>	Integer	1 to 50000	1
<mk>	Integer	1 to 16	1
<type>	Discrete	{OFF PEAK TARGet}	OFF

### Remarks

- OFF: disables multi peak and target search.
- PEAK: performs the multi peak search. It displays at most the first 16 peaks.
- TARGet: performs multi target search and searches for all the target values. At most, if the number of the target points exceeds 16, only the first 16 target values can be displayed.

### Return Format

The query returns OFF, PEAK, or TARG.

### Example

```
:CALCulate1:MEASure1:MARKer1:FUNction:MULTi:EXECute TARGet /
*Performs the multi target search.*/
:CALCulate1:MEASure1:MARKer1:FUNction:MULTi:EXECute? /*The query
returns TARG.*/
```

## 7.24.28 :CALCulate<cn>:MEASure<mn>:MARKer<mk>:FUNction:MULTi:SElect

### Syntax

```
:CALCulate<cn>:MEASure<mn>:MARKer<mk>:FUNction:MULTi:SElect <type>
```

```
:CALCulate<cn>:MEASure<mn>:MARKer<mk>:FUNction:MULTi:SElect?
```

### Description

Sets the search type to multi peak or multi target search for the specified measurement trace.

Queries whether the search type is multi peak or multi target search for the specified measurement trace.

### Parameter

Name	Type	Range	Default
<cn>	Integer	1 to 500	1
<mn>	Integer	1 to 50000	1
<mk>	Integer	1 to 16	1
<type>	Discrete	{OFF PEAK TARGet}	OFF

### Remarks

- OFF: disables multi peak and multi target search.
- PEAK: sets the search to multi peak search.
- TARGet: sets the search to multi target search.

### Return Format

The query returns OFF, PEAK, or TARG.

### Example

```
:CALCulate1:MEASure1:MARKer1:FUNction:MULTi:SElect PEAK /*Sets the
search type to multi peak search.*/
:CALCulate1:MEASure1:MARKer1:FUNction:MULTi:SElect? /*The query
returns PEAK.*/
```

## 7.24.29 :CALCulate<cn>:MEASure<mn>:MARKer<mk>:FUNction:MULTi:TRACking

### Syntax

```
:CALCulate<cn>:MEASure<mn>:MARKer<mk>:FUNction:MULTi:TRACking
<bool>
```

```
:CALCulate<cn>:MEASure<mn>:MARKer<mk>:FUNction:MULTi:TRACking?
```

**Description**

Enables or disables the tracking function in the multi peak and target search for the specified marker.

Queries the on/off status of the tracking function in the multi peak and target search for the specified marker.

**Parameter**

Name	Type	Range	Default
<cn>	Integer	1 to 500	1
<mn>	Integer	1 to 50000	1
<mk>	Integer	1 to 16	1
<bool>	Bool	{{1 ON}}{0 OFF}}	0 OFF

**Remarks**

When you enable the search tracking function, it functions the same as running the `:CALCulate<cn>:MEASure<mn>:MARKer<mk>:FUNctioN:EXECute` command for each sweep.

**Return Format**

The query returns 1 or 0.

**Example**

```
:CALCulate1:MEASure1:MARKer1:FUNctioN:MULTi:TRACking ON /*Enables
the tracking function in the multi peak and target search for
Marker 1.*/
:CALCulate1:MEASure1:MARKer1:FUNctioN:MULTi:TRACking? /*The query
returns 1.*/
```

**7.24.30 :CALCulate<cn>:MEASure<mn>:MARKer<mk>:SET****Syntax**

```
:CALCulate<cn>:MEASure<mn>:MARKer<mk>:SET <type>
```

**Description**

Sets the selected instrument setting to assume the value of the specified marker.

**Parameter**

Name	Type	Range	Default
<cn>	Integer	1 to 500	1
<mn>	Integer	1 to 50000	1

Name	Type	Range	Default
<mk>	Integer	1 to 16	1
<value>	Real	{CENTer SPAN START STOP  RLEVel DELay CWFReq}	-

### Remarks

- **CENTer**: sets the center frequency of the sweep to the value of the marker (current marker position in the X-axis).
- **SPAN**: sets the sweep span to the span between the current marker and the delta marker. It is unavailable if there is no Delta marker.
- **START**: sets the start frequency of the sweep to the value of the marker (current marker position in the X-axis).
- **STOP**: sets the stop frequency of the sweep to the value of the marker (current marker position in the X-axis).
- **RLEVel**: sets the response value (Y-axis) of the marker to the level level of the current trace.
- **DELay**: sets the phase slope at the current marker stimulus position to the line length at the receiver input.
- **CWFReq**: sets the CW frequency to the position (frequency) of the current marker. It will not change the sweep type. It is not available in power sweep. After running this command to modify the CW frequency, enabling power sweep can apply the modified CW frequency setting.

### Return Format

The query returns CENT, SPAN, STAR, STOP, RLEV, DEL, or CWFR.

### Example

```
:CALCulate1:MEASure1:MARKer1:SET CENT /*Sets the center frequency of the sweep to the value of the marker (current marker position).*/
```

## 7.25 :CALCulate<cn>:MEASure<mn>:LIMit Commands

The :CALCulate<cn>:MEASure<mn>:LIMit commands are used to set the limit test related parameters.

Limit test compares the measured data with the defined limit value to judge whether the measured data meet the PASS or FAIL conditions.

## 7.25.1 :CALCulate<cn>:MEASure<mn>:LIMit[:STATe]

### Syntax

```
:CALCulate<cn>:MEASure<mn>:LIMit[:STATe] <bool>
```

```
:CALCulate<cn>:MEASure<mn>:LIMit[:STATe]?
```

### Description

Enables or disables the limit test for the specified measurement trace.

Queries on/off status of the limit test for the specified measurement trace.

### Parameter

Name	Type	Range	Default
<cn>	Integer	1 to 500	1
<mn>	Integer	1 to 50000	1
<bool>	Bool	{{1 ON}}{0 OFF}}	0 OFF

### Remarks

After enabling the limit test, you can run the `:CALCulate<cn>:MEASure<mn>:LIMit:DISPlay[:STATe]` command to enable or disable the display of the limit line of the specified measurement trace.

### Return Format

The query returns 1 or 0.

### Example

```
:CALCulate1:MEASure1:LIMit ON /*Enables the limit test for the
measurement trace 1.*/
:CALCulate1:MEASure1:LIMit? /*The query returns 1.*/
```

## 7.25.2 :CALCulate<cn>:MEASure<mn>:LIMit:SOUNd[:STATe]

### Syntax

```
:CALCulate<cn>:MEASure<mn>:LIMit:SOUNd[:STATe] <bool>
```

```
:CALCulate<cn>:MEASure<mn>:LIMit:SOUNd[:STATe]?
```

### Description

Enables or disables the beeper when the limit test is found to be failed.

Queries whether the beeper sounds when the limit test is found to be failed.

**Parameter**

Name	Type	Range	Default
<cn>	Integer	1 to 500	1
<mn>	Integer	1 to 50000	1
<bool>	Bool	{{1 ON}}{0 OFF}}	0 OFF

**Remarks**

N/A

**Return Format**

The query returns 1 or 0.

**Example**

```
:CALCulate1:MEASure1:LIMit:SOUND ON /*Enables the beeper to sound
when the limit is found to be failed.*/
:CALCulate1:MEASure1:LIMit:SOUND? /*The query returns 1.*/
```

### 7.25.3 :CALCulate<cn>:MEASure<mn>:LIMit:DISPlay[:STATe]

**Syntax**

```
:CALCulate<cn>:MEASure<mn>:LIMit:DISPlay[:STATe] <bool>
```

```
:CALCulate<cn>:MEASure<mn>:LIMit:DISPlay[:STATe]?
```

**Description**

Enables or disables the display of the limit line for the specified measurement trace.

Queries the display of the limit line for the specified measurement trace.

**Parameter**

Name	Type	Range	Default
<cn>	Integer	1 to 500	1
<mn>	Integer	1 to 50000	1
<bool>	Bool	{{1 ON}}{0 OFF}}	0 OFF

**Remarks**

N/A

**Return Format**

The query returns 1 or 0.

**Example**

```
:CALCulate1:MEASure1:LIMit:DISPlay ON /*Enables the display of the
limit line for measurement trace 1.*/
:CALCulate1:MEASure1:LIMit:DISPlay? /*The query returns 1.*/
```

## 7.25.4 :CALCulate<cn>:MEASure<mn>:LIMit:SEGMENT<sgn>:TYPE

### E

**Syntax**

```
:CALCulate<cn>:MEASure<mn>:LIMit:SEGMENT<sgn>:TYPE <type>
```

```
:CALCulate<cn>:MEASure<mn>:LIMit:SEGMENT<sgn>:TYPE?
```

**Description**

Sets the judge rule of the limit test for the specified limit line of the specified measurement trace.

Queries the judge rule of the limit test for the specified limit line of the specified measurement trace.

**Parameter**

Name	Type	Range	Default
<cn>	Integer	1 to 500	1
<mn>	Integer	1 to 50000	1
<sgn>	Integer	1 to 32	1
<type>	Discrete	{OFF LMAX LMIN}	OFF

**Remarks**

- **OFF:** disables the limit line and hides the limit line.
- **LMAX:** Any response data exceeding the MAX value will fail.
- **LMIN:** Any response data below the MIN value will fail.

**Return Format**

The query returns OFF, LMAX, or LMIN.

**Example**

```
:CALCulate1:MEASure1:LIMit:SEGMENT1:TYPE LMIN /*Sets the judge rule
of Limit1 of measurement trace 1 to LMIN.*/
:CALCulate1:MEASure1:LIMit:SEGMENT1:TYPE? /*The query returns
LMIN.*/
```

## 7.25.5 :CALCulate<cn>:MEASure<mn>:LIMit:SEGment<sgn>:STIMulus:START

### Mulus:START

#### Syntax

```
:CALCulate<cn>:MEASure<mn>:LIMit:SEGment<sgn>:STIMulus:START
<value>
```

```
:CALCulate<cn>:MEASure<mn>:LIMit:SEGment<sgn>:STIMulus:START?
```

#### Description

Sets the X-axis begin stimulus value of the specified limit line of the specified measurement trace.

Queries the X-axis begin stimulus value of the specified limit line of the specified measurement trace.

#### Parameter

Name	Type	Range	Default
<cn>	Integer	1 to 500	1
<mn>	Integer	1 to 50000	1
<sgn>	Integer	1 to 32	1
<value>	Real	Refer to Remarks	0

#### Remarks

The parameter <value> can only be any value within the X-axis range for the specified measurement trace. The X-axis range and unit are determined by the data format (:CALCulate<cn>:MEASure<mn>:FORMat) of the specified trace.

#### Return Format

The query returns X-axis begin stimulus value in scientific notation.

#### Example

```
:CALCulatel:MEASurel:LIMit:SEGmentl:STIMulus:START 10000000 /*Sets
1 the X-axis begin stimulus value of Limitl of measurement trace 1
to 10 MHz.*/
:CALCulatel:MEASurel:LIMit:SEGmentl:STIMulus:START? /*The query
returns 1.00e+07.*/
```

## 7.25.6 :CALCulate<cn>:MEASure<mn>:LIMit:SEGment<sgn>:STIMulus:STOP

### Mulus:STOP

#### Syntax

```
:CALCulate<cn>:MEASure <mn> :LIMit:SEGment<sgn> :STIMulus:STOP <value>
```

```
:CALCulate<cn>:MEASure<mn>:LIMit:SEGment<sgn>:STIMulus:STOP?
```

#### Description

Sets the X-axis end stimulus value of the specified limit line of the specified measurement trace.

Queries the X-axis end stimulus value of the specified limit line of the specified measurement trace.

#### Parameter

Name	Type	Range	Default
<cn>	Integer	1 to 500	1
<mn>	Integer	1 to 50000	1
<sgn>	Integer	1 to 32	0
<value>	Real	Refer to Remarks	0

#### Remarks

The parameter <value> can only be any value within the X-axis range for the specified measurement trace. The X-axis range and unit are determined by the data format (:CALCulate<cn>:MEASure<mn>:FORMat) of the specified trace.

#### Remarks

N/A

#### Return Format

The query returns X-axis end stimulus value in scientific notation.

#### Example

```
:CALCulate1:MEASure1:LIMit:SEGment1:STIMulus:STOP 10000000 /*Sets
the X-axis end stimulus value of Limit Line 1 for the measurement
trace 1 to 10 MHz.*/
:CALCulate1:MEASure1:LIMit:SEGment1:STIMulus:STOP? /*The query
returns 1.00e+07.*/
```

## 7.25.7 :CALCulate<cn>:MEASure<mn>:LIMit:SEGment<sgn>:AMPLitude:START

### Syntax

```
:CALCulate<cn>:MEASure<mn>:LIMit:SEGment<sgn>:AMPLitude:START
<value>
```

```
:CALCulate<cn>:MEASure<mn>:LIMit:SEGment<sgn>:AMPLitude:START?
```

### Description

Sets the Y-axis begin response value of the specified limit line of the specified measurement trace.

Queries the Y-axis begin response value of the specified limit line of the specified measurement trace.

### Parameter

Name	Type	Range	Default
<cn>	Integer	1 to 500	1
<mn>	Integer	1 to 50000	1
<sgn>	Integer	1 to 32	1
<value>	Real	Refer to Remarks	0

### Remarks

The parameter <value> can only be any value within the Y-axis range for the specified measurement trace. The Y-axis range and unit are determined by the data format (:CALCulate<cn>:MEASure<mn>:FORMat) of the specified trace.

### Return Format

The query returns the Y-axis begin response value in scientific notation.

### Example

```
:CALCulatel:MEASurel:LIMit:SEGmentl:AMPLitude:START 100 /*Sets 1
the Y-axis begin response value of Limit1 of measurement trace 1 to
100 dB.*/
:CALCulatel:MEASurel:LIMit:SEGmentl:AMPLitude:START? /*The query
returns 1.00e+02.*/
```

## 7.25.8 :CALCulate<cn>:MEASure<mn>:LIMit:SEGment<sgn>:AMPLitude:STOP

### Syntax

```
:CALCulate<cn>:MEASure<mn>:LIMit:SEGment<sgn>:AMPLitude:STOP
<value>
```

```
:CALCulate<cn>:MEASure<mn>:LIMit:SEGment<sgn>:AMPLitude:STOP?
```

### Description

Sets the Y-axis end response value of the specified limit line for the specified measurement trace.

Queries the Y-axis end response value of the specified limit line for the specified measurement trace.

### Parameter

Name	Type	Range	Default
<cn>	Integer	1 to 500	1
<mn>	Integer	1 to 50000	1
<sgn>	Integer	1 to 32	0
<value>	Real	Refer to Remarks	0

### Remarks

The parameter <value> can only be any value within the Y-axis range for the specified measurement trace. The Y-axis range and unit are determined by the data format (:CALCulate<cn>:MEASure<mn>:FORMat) of the specified trace.

### Return Format

The query returns the Y-axis end response value in scientific notation.

### Example

```
:CALCulatel:MEASurel:LIMit:SEGmentl:AMPLitude:STOP 100 /*Sets the Y-
axis end response value of Limit Line 1 for the measurement trace 1
to 100 dB.*/
:CALCulatel:MEASurel:LIMit:SEGmentl:AMPLitude:STOP? /*The query
returns 1.00e+02.*/
```

## 7.25.9 :CALCulate<cn>:MEASure<mn>:LIMit:FAIL?

### Syntax

```
:CALCulate<cn>:MEASure<mn>:LIMit:FAIL?
```

**Description**

Queries the pass/fail state of the limit test for the specified measurement trace.

**Parameter**

Name	Type	Range	Default
<cn>	Integer	1 to 500	1
<mn>	Integer	1 to 50000	1

**Remarks**

- If any one of the measurement response data points exceeds the limit test rule, the query returns 1 (failed).
- If all of the measurement response data points meet the limit test rule, the query returns 0 (pass).

**Return Format**

The query returns 1 or 0.

**Example**

N/A

## 7.26 :CALCulate<cn>:MEASure<mn>:DELay Commands

The :CALCulate <cn>:MEASure<mn>:DELay commands are used to set the delay test-related parameters.

### 7.26.1 :CALCulate<cn>:MEASure<mn>:DELay:STATE

**Syntax**

```
:CALCulate<cn>:MEASure<mn>:DELay:STATE <bool>
```

```
:CALCulate<cn>:MEASure<mn>:DELay:STATE?
```

**Description**

Enables or disables the delay test for the specified trace.

Queries the on/off status of the delay test for the specified trace.

**Parameter**

Name	Type	Range	Default
<cn>	Integer	1 to 500	1

Name	Type	Range	Default
<mn>	Integer	1 to 50000	1
<bool>	Bool	{{1 ON}}{0 OFF}}	0 OFF

### Remarks

After the delay test is enabled, the system will perform the following operation.

- Enable the transform state (**Time Domain** > **Transform State**).
- Set the transform type to "Low Pass Step" (**Time Domain** > **Transform Type**).
- Set the trace data format for the delay test to Real.
- Start the delay test for the current trace. The delay test result for the trace is displayed at the top part of the window.

### Return Format

The query returns 1 or 0.

### Example

```
:CALCulate1:MEASure1:DElay:STATE ON /*Enables the delay test for
Trace 1.*/
:CALCulate1:MEASure1:DElay:STATE? /*The query returns 1.*/
```

## 7.26.2 :CALCulate<cn>:MEASure<mn>:DElay:POStion

### Syntax

```
:CALCulate<cn>:MEASure<mn>:DElay:POStion <freq>
```

```
:CALCulate<cn>:MEASure<mn>:DElay:POStion?
```

### Description

Sets the delay threshold for the specified trace.

Queries the delay threshold for the specified trace.

### Parameter

Name	Type	Range	Default
<cn>	Integer	1 to 500	1
<mn>	Integer	1 to 50000	1
<freq>	Real	10 to 90	50

**Remarks**

N/A

**Return Format**

The query returns the delay threshold in scientific notation.

**Example**

```
:CALCulate1:MEASure1:DElay:POsition 60 /*Sets the delay threshold
for Trace 1 to 60%.*/
:CALCulate1:MEASure1:DElay:POsition? /*The query returns
6.0e+01.*/
```

## 7.26.3 :CALCulate<cn>:MEASure<mn>:DElay:DATA?

**Syntax**

```
:CALCulate<cn>:MEASure<mn>:DElay:DATA?
```

**Description**

Queries the delay results for the specified trace.

**Parameter**

Name	Type	Range	Default
<cn>	Integer	1 to 500	1
<mn>	Integer	1 to 50000	1

**Remarks**

N/A

**Return Format**

The query returns the the delay measurement results in scientific notation.

**Example**

```
:CALCulate1:MEASure1:DElay:DATA? /*The query returns 1.00e-02.*/
```

## 7.27 :CALCulate<cn>:MEASure<mn>:DTIME Commands

The :CALCulate<cn>:MEASure<mn>:DTIME commands are used to set the skew test-related parameters.

### 7.27.1 :CALCulate<cn>:MEASure<mn>:DTIME:STATE

**Syntax**

```
:CALCulate<cn>:MEASure<mn>:DTIME:STATE <bool>
```

:CALCulate<cn>:MEASure<mn>:DTIME:STATe?

### Description

Enables or disables the skew state for the specified trace.

Queries the on/off status of the skew state for the specified trace.

### Parameter

Name	Type	Range	Default
<cn>	Integer	Channel No.	-
<mn>	Integer	Measurement No.	-
<bool>	Discrete	ON OFF 1 0	-

### Remarks

After the skew test is enabled, the system will perform the following operation.

- Enable the transform state (**Time Domain** > **Transform State**).
- Set the transform type to "Low Pass Step" (**Time Domain** > **Transform Type**).
- Set the trace data format for the skew test to Real.
- Start the skew test for the current trace. The skew test result for the trace is displayed at the top part of the window.

### Return Format

The query returns 1 or 0.

### Example

```
:CALCulate1:MEASure1:DTIME ON /*Enables the skew state for Trace 1.*/
:CALCulate1:MEASure1:DTIME? /*The query returns 1.*/
```

## 7.27.2 :CALCulate<cn>:MEASure<mn>:DTIME:POSition

### Syntax

:CALCulate<cn>:MEASure<mn>:DTIME:POSition <freq>

:CALCulate<cn>:MEASure<mn>:DTIME:POSition?

### Description

Sets the skew threshold for the specified trace.

Queries the skew threshold for the specified trace.

**Parameter**

Name	Type	Range	Default
<cn>	Integer	1 to 500	1
<mn>	Integer	1 to 50000	1
<freq>	Real	10 to 90	50

**Remarks**

N/A

**Return Format**

The query returns the skew threshold in scientific notation.

**Example**

```
:CALCulate1:MEASure1:DTIME:POSition 60 /*Sets the skew threshold
for Trace 1 to 60%.*/
:CALCulate1:MEASure1:DTIME:POSition? /*The query returns
6.0e+01.*/
```

### 7.27.3 :CALCulate<cn>:MEASure<mn>:DTIME:TARGet

**Syntax**

```
:CALCulate<cn>:MEASure<mn>:DTIME:TARGet <rmn>
```

```
:CALCulate<cn>:MEASure<mn>:DTIME:TARGet?
```

**Description**

Sets the reference trace of the skew measurement for the specified trace.

Queries the reference trace of the skew measurement for the specified trace.

**Parameter**

Name	Type	Range	Default
<cn>	Integer	1 to 500	1
<mn>	Integer	1 to 50000	1
<rmn>	Integer	1 to 50000	-

**Remarks**

N/A

**Return Format**

The query returns the reference trace of the skew measurement for the specified trace in integer.

**Example**

```
:CALCulate1:MEASure1:DTIME:TARGet 3 /*Sets the reference trace of
the skew measurement for Trace 1 to Trace 3.*/
:CALCulate1:MEASure1:DTIME:TARGet? /*The query returns 3.*/
```

**7.27.4 :CALCulate<cn>:MEASure<mn>:DTIME:DATA?****Syntax**

```
:CALCulate<cn>:MEASure<mn>:DTIME:DATA?
```

**Description**

Queries the skew test result for the specified trace.

**Parameter**

Name	Type	Range	Default
<cn>	Integer	1 to 500	1
<mn>	Integer	1 to 50000	1

**Remarks**

N/A

**Return Format**

The query returns the skew test results in strings, separated by commas.

**Example**

```
:CALCulate1:MEASure1:DTIME:DATA? /*The query returns
0.001,0.002,0.001,0.002.*/
```

**7.27.5 :CALCulate<cn>:MEASure<mn>:DTIME:LIMit:STATE****Syntax**

```
:CALCulate<cn>:MEASure<mn>:DTIME:LIMit:STATE <bool>
```

```
:CALCulate<cn>:MEASure<mn>:DTIME:LIMit:STATE?
```

**Description**

Enables or disables the skew check for the specified trace.

Queries the on/off status of the skew check for the specified trace.

**Parameter**

Name	Type	Range	Default
<cn>	Integer	Channel No.	-
<mn>	Integer	Measurement No.	-
<bool>	Discrete	ON OFF 1 0	-

**Remarks**

This command takes effect when the skew state is enabled  
(*:CALCulate<cn>:MEASure<mn>:DTIME:STATE*).

**Return Format**

The query returns 1 or 0.

**Example**

```
:CALCulate1:MEASure1:DTIME:LIMit:STATE ON /*Enables the skew check
for Trace 1.*/
:CALCulate1:MEASure1:DTIME:LIMit:STATE? /*The query returns 1.*/
```

**7.27.6 :CALCulate<cn>:MEASure<mn>:DTIME:LIMit:LIMit****Syntax**

```
:CALCulate<cn>:MEASure<mn>:DTIME:LIMit:LIMit <freq>
```

```
:CALCulate<cn>:MEASure<mn>:DTIME:LIMit:LIMit?
```

**Description**

Sets the skew limit for the specified trace.

Queries the skew limit for the specified trace.

**Parameter**

Name	Type	Range	Default
<cn>	Integer	1 to 500	1
<mn>	Integer	1 to 50000	1
<freq>	Real	-10e+15 s to 1.0e+15 s	0

**Remarks**

N/A

**Return Format**

The query returns the skew limit in scientific notation. The unit is s.

**Example**

```
:CALCulate1:MEASure1:DTIME:LIMit:LIMit 0.001 /*Sets the skew limit
for Trace 1 to1 ms.*/
:CALCulate1:MEASure1:DTIME:LIMit:LIMit? /*The query
returns 1.0e-3.*/
```

**7.27.7 :CALCulate<cn>:MEASure<mn>:DTIME:LIMit:FAIL?****Syntax**

```
:CALCulate<cn>:MEASure<mn>:DTIME:LIMit:FAIL?
```

**Description**

Queries the pass/fail state based on the skew limit set for the specified trace.

**Parameter**

Name	Type	Range	Default
<cn>	Integer	1 to 500	1
<mn>	Integer	1 to 50000	1

**Remarks**

- The query returns 1 (failure) whenever any one of the measurement response data points exceeds the value set for the skew limit.
- The query returns 0 if all the measurement response data points meet the value set for the skew limit.

**Return Format**

The query returns 1 or 0.

**Example**

N/A

**7.28 :CALCulate<cn>:MEASure<mn>:SMOothing Commands**

The :CALCulate<cn>:MEASure<mn>:SMOothing commands are used to set and query the smoothing function related parameters.

**7.28.1 :CALCulate<cn>:MEASure<mn>:SMOothing[:STATE]****Syntax**

```
:CALCulate<cn>:MEASure<mn>:SMOothing[:STATE] <bool>
```

```
:CALCulate<cn>:MEASure<mn>:SMOothing[:STATe]?
```

### Description

Sets whether to enable the smoothing function for the specified measurement trace.

Queries whether to enable the smoothing function for the specified measurement trace.

### Parameter

Name	Type	Range	Default
<cn>	Integer	1 to 500	1
<mn>	Integer	1 to 50000	1
<bool>	Bool	{{1 ON}}{0 OFF}}	0 OFF

### Remarks

In the Avg BW menu, enabling smoothing can average a number of adjacent data points to smooth the displayed trace.

If the data format (:CALCulate<cn>:MEASure<mn>:FORMat) is set to POLar or SMITH, smoothing is automatically disabled. The smoothing setting will not take effect.

### Return Format

The query returns 1 or 0.

### Example

```
:CALCulate1:MEASure1:SMOothing ON /*Enables smoothing.*/
:CALCulate1:MEASure1:SMOothing? /*The query returns 1.*/
```

## 7.28.2 :CALCulate<cn>:MEASure<mn>:SMOothing:APERture

### Syntax

```
:CALCulate<cn>:MEASure<mn>:SMOothing:APERture <value>
```

```
:CALCulate<cn>:MEASure<mn>:SMOothing:APERture?
```

### Description

Sets the smoothing aperture of the specified measurement trace.

Queries the smoothing aperture of the specified measurement trace.

### Parameter

Name	Type	Range	Default
<cn>	Integer	1 to 500	1

Name	Type	Range	Default
<mn>	Integer	1 to 50000	1
<value>	Real	0% to 25%	1%

**Remarks**

Smoothing aperture specifies the amount of smoothing as a ratio of the number of data points in the measurement trace.

**Return Format**

The query returns the smoothing aperture in scientific notation. The unit is %.

**Example**

```
:CALCulate1:MEASure1:SMOothing:APERture 2 /*Sets the smoothing
aperture to 2%.*/
:CALCulate1:MEASure1:SMOothing:APERture? /*The query
returns 2.00e-02.*/
```

### 7.28.3 :CALCulate<cn>:MEASure<mn>:SMOothing:POINTS

**Syntax**

```
:CALCulate<cn>:MEASure<mn>:SMOothing:POINTS <num>
```

```
:CALCulate<cn>:MEASure<mn>:SMOothing:POINTS?
```

**Description**

Sets the number of smoothing points for the specified measurement trace.

Queries the number of smoothing points for the specified measurement trace.

**Parameter**

Name	Type	Range	Default
<cn>	Integer	1 to 500	1
<mn>	Integer	1 to 50000	1
<num>	Integer	1 to 25001	3

**Remarks**

<num> indicates the number of adjacent points to average. It can only be an odd number. The range of <num> is related to the total channel data sweep points (*:SENSe<cn>:SWEep:POINTS*). The max. value of <num> is 25% of the number of the channel data points.

**Return Format**

The query returns the number of smoothing points in integer.

**Example**

```
:CALCulate1:MEASure1:SMOothing:POINts 100 /*Sets the number of
smoothing points to 100.*/
:CALCulate1:MEASure1:SMOothing:POINts? /*The query returns 100.*/
```

## 7.29 :CALCulate<cn>:MEASure<mn>:CORRection:EDELa y Commands

The :CALCulate<cn>:MEASure<mn>:CORRection:EDELa y commands are used to set and query the electrical delay function parameters.

Electrical Delay refers to the linear phase delay caused by the physical length and dielectric constant when a signal transmits in the device under test.

For the vector network analyzer, the electrical delay is used to compensate the phase offset caused by transmission cable length or other factors to make the measurement results more accurate. Setting the electrical delay parameters for each measurement trace will affect the phase related results of the trace and the trace display.

### 7.29.1 :CALCulate<cn>:MEASure<mn>:CORRection:EDELay:UNIT

**Syntax**

```
:CALCulate<cn>:MEASure<mn>:CORRection:EDELay:UNIT <type>
```

```
:CALCulate<cn>:MEASure<mn>:CORRection:EDELay:UNIT?
```

**Description**

Sets the distance unit of the electrical delay for the specified measurement trace.

Queries the distance unit of electrical delay for the specified measurement trace.

**Parameter**

Name	Type	Range	Default
<cn>	Integer	1 to 500	1
<mn>	Integer	1 to 50000	1
<type>	Discrete	{METer FEET INCH}	METer

**Remarks**

The parameter <type> can be set to METer, FEET, or INCH.

**Return Format**

The query returns MET, FEET, or INCH.

**Example**

```
:CALCulate1:MEASure1:CORRection:EDELay:UNIT FEET /*Sets the
distance unit of the electrical delay for measurement trace 1 to
FEET.*/
:CALCulate1:MEASure1:CORRection:EDELay:UNIT? /*The query returns
FEET.*/
```

## 7.29.2 :CALCulate<cn>:MEASure<mn>:CORRection:EDELay:DIStance

**Syntax**

```
:CALCulate<cn>:MEASure<mn>:CORRection:EDELay:DIStance <value>
```

```
:CALCulate<cn>:MEASure<mn>:CORRection:EDELay:DIStance?
```

**Description**

Sets the electrical delay distance for the specified measurement trace.

Queries the electrical delay distance for the specified measurement trace.

**Parameter**

Name	Type	Range	Default
<cn>	Integer	1 to 500	1
<mn>	Integer	1 to 50000	1
<value>	Real	Refer to Remarks	0

**Remarks**

To set the unit, run the *:CALCulate<cn>:MEASure<mn>:CORRection:EDELay:UNIT* command. To set the velocity factor, run the *:SENSe<cn>:CORRection:EXTension:PORT<pn>:VELFactor* command.

**Return Format**

The query returns the electrical delay distance in scientific notation.

**Example**

```
:CALCulate1:MEASure1:CORRection:EDELay:DIStance 2 /*Sets the
electrical delay distance for the measurement trace 1 to 2 m.*/
:CALCulate1:MEASure1:CORRection:EDELay:DIStance? /*The query
returns 2.00e+00.*/
```

### 7.29.3 :CALCulate<cn>:MEASure<mn>:CORRection:EDELay[:TIM E]

#### Syntax

```
:CALCulate<cn>:MEASure<mn>:CORRection:EDELay[:TIME] <bool>
```

```
:CALCulate<cn>:MEASure<mn>:CORRection:EDELay[:TIME]?
```

#### Description

Sets the electrical delay time for the specified measurement trace.

Queries the electrical delay time for the specified measurement trace.

#### Parameter

Name	Type	Range	Default
<cn>	Integer	1 to 500	1
<mn>	Integer	1 to 50000	1
<value>	Real	-10 s to 10 s	0

#### Remarks

To set and query the velocity factor, run

the *:SENSe<cn>:CORRection:EXTension:PORT<pn>:VELFactor* command.

#### Return Format

The returns the electrical delay time in scientific notation. The unit is s.

#### Example

```
:CALCulate1:MEASure1:CORRection:EDELay 0.5e-12 /*Sets the
electrical delay time to 0.5 ps.*/
:CALCulate1:MEASure1:CORRection:EDELay? /*The query
returns +5.00E-13.*/
```

## 7.30 :CALCulate<cn>:MEASure<mn>:OFFSet Commands

The :CALCulate<cn>:MEASure<mn>:OFFSet commands are used to set and query the offset parameters.

### 7.30.1 :CALCulate<cn>:MEASure<mn>:OFFSet:MAGNitude

#### Syntax

```
:CALCulate<cn>:MEASure<mn>:OFFSet:MAGNitude <value>
```

```
:CALCulate<cn>:MEASure<mn>:OFFSet:MAGNitude?
```

**Description**

Sets the magnitude offset for the specified measurement trace.

Queries the magnitude offset for the specified measurement trace.

**Parameter**

Name	Type	Range	Default
<cn>	Integer	1 to 500	1
<mn>	Integer	1 to 50000	1
<value>	Real	-1E15 to 1E15	0 dB

**Remarks**

To set the magnitude offset slope to observe the magnitude offset variation with the frequency, run the `:CALCulate<cn>:MEASure<mn>:OFFSet:MAGNitude:SLOPe` command

**Return Format**

The query returns the magnitude offset in scientific notation. The unit is dB.

**Example**

```
:CALCulate1:MEASure1:OFFSet:MAGNitude 2000000 /*Sets the magnitude
offset to 2 MdB.*/
:CALCulate1:MEASure1:OFFSet:MAGNitude? /*The query
returns 2.00e+06.*/
```

## 7.30.2 :CALCulate<cn>:MEASure<mn>:OFFSet:MAGNitude:SLOPe

**Syntax**

```
:CALCulate<cn>:MEASure<mn>:OFFSet:MAGNitude:SLOPe <value>
```

```
:CALCulate<cn>:MEASure<mn>:OFFSet:MAGNitude:SLOPe?
```

**Description**

Sets the magnitude offset slope for the specified measurement trace.

Queries the magnitude offset slope for the specified measurement trace.

**Parameter**

Name	Type	Range	Default
<cn>	Integer	1 to 500	1
<mn>	Integer	1 to 50000	1

Name	Type	Range	Default
<value>	Real	-1E15 to 1E15	0

**Remarks**

The magnitude offset slope refers to the magnitude offset varies with frequency at the specified slope. The offset slope begins begins at 0 Hz, in dB/GHz.

**Return Format**

The query returns the magnitude offset slope in scientific notation. The unit is dB/GHz.

**Example**

```
:CALCulate1:MEASure1:OFFSet:MAGNitude:SLOPe 2000000 /*Sets the
magnitude offset slope to 2 MdB/GHz.*/
:CALCulate1:MEASure1:OFFSet:MAGNitude:SLOPe? /*The query
returns 2.00e+06.*/
```

### 7.30.3 :CALCulate<cn>:MEASure<mn>:OFFSet:PHASe

**Syntax**

```
:CALCulate<cn>:MEASure<mn>:OFFSet:PHASe <value>
```

```
:CALCulate<cn>:MEASure<mn>:OFFSet:PHASe?
```

**Description**

Sets the phase offset for the specified measurement trace.

Queries the phase offset for the specified measurement trace.

**Parameter**

Name	Type	Range	Default
<cn>	Integer	1 to 500	1
<mn>	Integer	1 to 50000	1
<value>	Real	-1E15 to 1E15	0

**Remarks**

N/A

**Return Format**

The query returns the phase offset in scientific notation. Its unit is degree (°).

**Example**

```
:CALCulate1:MEASure1:OFFSet:PHASe 1 /*Sets the phase offset to 1°.*/
:CALCulate1:MEASure1:OFFSet:PHASe? /*The query returns 1.00e+00.*/
```

## 7.31 :CALCulate<cn>:MEASure<mn>:TRANSform Commands

The CALCulate<cn>:MEASure<mn>:TRANSform commands are used to set and query the relevant settings for time domain transform and DTF function.

The time domain analysis function can transform the frequency domain measurement data into time domain display. Its X-axis represents time. It can be used to analysis the time domain characteristics of the signal, such as pulse response, time delay, etc.

### 7.31.1 :CALCulate<cn>:MEASure<mn>:TRANSform:TIME:STATE

#### Syntax

```
:CALCulate<cn>:MEASure<mn>:TRANSform:TIME:STATE <bool>
```

```
:CALCulate<cn>:MEASure<mn>:TRANSform:TIME:STATE?
```

#### Description

Enables or disables the time domain transform for the specified measurement trace.

Queries the on/off status of the time domain transform for the specified measurement trace.

#### Parameter

Name	Type	Range	Default
<cn>	Integer	1 to 500	1
<mn>	Integer	1 to 50000	1
<bool>	Bool	{{1 ON}} {{0 OFF}}	0 OFF

#### Remarks

When the time domain transform state is enabled, the X-axis coordinate in the window turns out to be in time unit.

#### Return Format

The query returns 1 or 0.

#### Example

```
:CALCulate1:MEASure1:TRANSform:TIME:STATE ON /*Enables the time domain transform for measurement trace 1.*/
:CALCulate1:MEASure1:TRANSform:TIME:STATE? /*The query returns 1.*/
```

## 7.31.2 :CALCulate<cn>:MEASure<mn>:TRANSform:TIME:START

### Syntax

```
:CALCulate<cn>:MEASure<mn>:TRANSform:TIME:START <value>
```

```
:CALCulate<cn>:MEASure<mn>:TRANSform:TIME:START?
```

### Description

Sets the transform start time of time domain analysis for the specified measurement trace.

Queries the transform start time of time domain analysis for the specified measurement trace.

### Parameter

Name	Type	Range	Default
<cn>	Integer	1 to 500	1
<mn>	Integer	1 to 50000	1
<value>	Real	Refer to Remarks	-10 ns

### Remarks

The range of <value> is  $\pm(\text{points} - 1) / \text{frequency span}$ .

To set or query the frequency span, run the `:CALCulate<cn>:MEASure<mn>:TRANSform:TIME:SPAN` command.

To set or query the sweep points, run the `:SENSe<cn>:SWEep:POINts` command.

### Return Format

The query returns the transform start time in scientific notation. The unit is s.

### Example

```
:CALCulate1:MEASure1:TRANSform:TIME:START 1e-8 /*Sets the transform
start time to 10 ns.*/
:CALCulate1:MEASure1:TRANSform:TIME:START? /*The query
returns 1.00e-08.*/
```

## 7.31.3 :CALCulate<cn>:MEASure<mn>:TRANSform:TIME:STOP

### Syntax

```
:CALCulate<cn>:MEASure<mn>:TRANSform:TIME:STOP <value>
```

```
:CALCulate<cn>:MEASure<mn>:TRANSform:TIME:STOP?
```

**Description**

Sets the stop time in time domain measurement of the specified measurement trace.  
 Queries the stop time in time domain measurement of the specified measurement trace.

**Parameter**

Name	Type	Range	Default
<cn>	Integer	1 to 500	1
<mn>	Integer	1 to 50000	1
<value>	Real	Refer to Remarks	10 ns

**Remarks**

The range of <value> is  $\pm(\text{points} - 1) / \text{frequency span}$ .

To set or query the frequency span, run the `:CALCulate<cn>:MEASure<mn>:TRANSform:TIME:SPAN` command.

To set or query the sweep points, run the `:SENSe<cn>:SWEep:POINts` command.

**Return Format**

The query returns the stop time in scientific notation. The unit is s.

**Example**

```
:CALCulate1:MEASure1:TRANSform:TIME:STOP 1e-8 /*Sets the stop time
to 10 ns.*/
:CALCulate1:MEASure1:TRANSform:TIME:STOP? /*The query
returns 1.00e-08.*/
```

**7.31.4 :CALCulate<cn>:MEASure<mn>:TRANSform:TIME:CENTer****Syntax**

```
:CALCulate<cn>:MEASure<mn>:TRANSform:TIME:CENTer <value>
```

```
:CALCulate<cn>:MEASure<mn>:TRANSform:TIME:CENTer?
```

**Description**

Sets the transform center time of time domain analysis for the specified measurement trace.

Queries the transform center time of time domain analysis for the specified measurement trace.

**Parameter**

Name	Type	Range	Default
<cn>	Integer	1 to 500	1
<mn>	Integer	1 to 50000	1
<value>	Real	Refer to Remarks	0

**Remarks**

The center time of the TDA is the center value between the start time (:CALCulate<cn>:MEASure<mn>:TRANSform:TIME:STARt) and the stop time (:CALCulate<cn>:MEASure<mn>:TRANSform:TIME:STOP).

**Return Format**

The query returns the center time of the TDA in scientific notation. The unit is s.

**Example**

```
:CALCulate1:MEASure1:TRANSform:TIME:CENTer 1e-8 /*Sets the center
time to 10 ns.*/
:CALCulate1:MEASure1:TRANSform:TIME:CENTer? /*The query
returns 1.00e-08.*/
```

## 7.31.5 :CALCulate<cn>:MEASure<mn>:TRANSform:TIME:SPAN

**Syntax**

```
:CALCulate<cn>:MEASure<mn>:TRANSform:TIME:SPAN <value>
```

```
:CALCulate<cn>:MEASure<mn>:TRANSform:TIME:SPAN?
```

**Description**

Sets the span time in time domain measurement for the specified measurement trace.

Queries the span time in time domain measurement for the specified measurement trace.

**Parameter**

Name	Type	Range	Default
<cn>	Integer	1 to 500	1
<mn>	Integer	1 to 50000	1
<value>	Real	Refer to Remarks	20 ns

**Remarks**

The span time is the difference between the stop time (:CALCulate<cn>:MEASure<mn>:TRANSform:TIME:STOP) time and start time (:CALCulate<cn>:MEASure<mn>:TRANSform:TIME:START) in the time domain measurement.

**Return Format**

The query returns the span time in the time domain measurement in scientific notation. The unit is s.

**Example**

```
:CALCulate1:MEASure1:TRANSform:TIME:SPAN 1e-8 /*Sets the span time
to 10 ns.*/
:CALCulate1:MEASure1:TRANSform:TIME:SPAN?           /*The query
returns 1.00e-08.*/
```

**7.31.6 :CALCulate<cn>:MEASure<mn>:TRANSform:TIME[:TYPE]****Syntax**

```
:CALCulate<cn>:MEASure<mn>:TRANSform:TIME[:TYPE] <type>
```

```
:CALCulate<cn>:MEASure<mn>:TRANSform:TIME[:TYPE]?
```

**Description**

Sets the transform type of time domain measurement for the specified measurement trace.

Queries the transform type of time domain measurement for the specified measurement trace.

**Parameter**

Name	Type	Range	Default
<cn>	Integer	1 to 500	1
<mn>	Integer	1 to 50000	1
<type>	Discrete	{BPASs LPSTep LPIMPulse}	BPASs

**Remarks**

- BPASs: indicates Band Pass.
- LPSTep: indicates Low Pass Step.
- LPIMPulse: indicates Low Pass Impulse.

**Return Format**

The query returns BPAS, LPST, or LPIM.

**Example**

```
:CALCulate1:MEASure1:TRANSform:TIME LPSTep /*Sets the transform
type of time domain measurement to LPSTep.*/
:CALCulate1:MEASure1:TRANSform:TIME? /*The query returns LPST.*/
```

## 7.31.7 :CALCulate<cn>:MEASure<mn>:TRANSform:TIME:LPFReq uency

**Syntax**

```
:CALCulate<cn>:MEASure<mn>:TRANSform:TIME:LPFRequency
```

**Description**

Sets the start frequency to be equal to the frequency span to be applicable to the low pass mode for the specified measurement trace.

**Parameter**

Name	Type	Range	Default
<cn>	Integer	1 to 500	1
<mn>	Integer	1 to 50000	1

**Remarks**

When the time transform type (`:CALCulate<cn>:MEASure<mn>:TRANSform:TIME[:TYPE]`) is set to LPSTep or LPIMPulse, it is in the Low Pass mode.

**Return Format**

N/A

**Example**

N/A

## 7.31.8 :CALCulate<cn>:MEASure<mn>:TRANSform:TIME:MARKer: MODE

**Syntax**

```
:CALCulate<cn>:MEASure<mn>:TRANSform:TIME:MARKer:MODE <type>
```

```
:CALCulate<cn>:MEASure<mn>:TRANSform:TIME:MARKer:MODE?
```

**Description**

Sets the marker mode in the Time Domain Setup (TDA) for the specified measurement trace.

Queries the marker mode in the Time Domain Setup (TDA) for the specified measurement trace.

**Parameter**

Name	Type	Range	Default
<cn>	Integer	1 to 500	1
<mn>	Integer	1 to 50000	1
<type>	Discrete	{AUTO REFlection TRANsmission}	AUTO

**Remarks**

- AUTO: selects the marker mode automatically according to the S-parameter of the current trace.
- REFlection: reflection measurement. It displays the distance from the source to the receiver divided by two (to compensate for the return trip.)
- TRANsmission: transmission measurement. It displays the distance from the source to the receiver.

**Return Format**

The query returns AUTO, REFL, or TRAN.

**Example**

```
:CALCulate1:MEASure1:TRANSform:TIME:MARKer:MODE REFlection /*Sets
the marker mode to REFlection.*/
:CALCulate1:MEASure1:TRANSform:TIME:MARKer:MODE? /*The query
returns REFL.*/
```

## 7.31.9 :CALCulate<cn>:MEASure<mn>:TRANSform:TIME:MARKer:UNIT

**Syntax**

```
:CALCulate<cn>:MEASure<mn>:TRANSform:TIME:MARKer:UNIT <type>
```

```
:CALCulate<cn>:MEASure<mn>:TRANSform:TIME:MARKer:UNIT?
```

**Description**

Sets the unit in the Time Domain Setup (TDA) for the specified measurement trace.

Queries the unit in the Time Domain Setup (TDA) for the specified measurement trace.

**Parameter**

Name	Type	Range	Default
<cn>	Integer	1 to 500	1
<mn>	Integer	1 to 50000	1
<type>	Discrete	{METRs FEET INCHes}	METRs

**Description**

The parameter <type> can be set to METRs, FEET, or INCHes.

**Return Format**

The query returns METR, FEET, or INCH.

**Example**

```
:CALCulate1:MEASure1:TRANSform:TIME:UNIT FEET /* Sets the unit in
Time Domain Setup (TDA) to FEET.*/
:CALCulate1:MEASure1:TRANSform:TIME:MARKer:UNIT? /*The query
returns FEET.*/
```

**7.31.10 :CALCulate<cn>:MEASure<mn>:TRANSform:TIME:KBESsel****Syntax**

```
:CALCulate<cn>:MEASure<mn>:TRANSform:TIME:KBESsel <value>
```

```
:CALCulate<cn>:MEASure<mn>:TRANSform:TIME:KBESsel?
```

**Description**

Sets the Kaiser Beta parameter in the Time Domain Setup (TDA) for the specified measurement trace.

Queries the Kaiser Beta parameter in the Time Domain Setup (TDA) for the specified measurement trace.

**Parameter**

Name	Type	Range	Default
<cn>	Integer	1 to 500	1
<mn>	Integer	1 to 50000	1

Name	Type	Range	Default
<value>	Real	0 to 13	6

**Remarks**

N/A

**Return Format**

The query returns the Kaiser Beta in scientific notation.

**Example**

```
:CALCulate1:MEASure1:TRANSform:TIME:KBESsel 5 /*Sets Kaiser Beta to 5.*/
:CALCulate1:MEASure1:TRANSform:TIME:KBESsel? /*The query returns 5.00e+00.*/
```

## 7.31.11 :CALCulate<cn>:MEASure<mn>:TRANSform:TIME:IMPulse:WIDTH

**Syntax**

```
:CALCulate<cn>:MEASure<mn>:TRANSform:TIME:IMPulse:WIDTH <value>
```

```
:CALCulate<cn>:MEASure<mn>:TRANSform:TIME:IMPulse:WIDTH?
```

**Description**

Sets the impulse width in the Time Domain Setup (TDA) for the specified measurement trace.

Queries the impulse width in the Time Domain Setup (TDA) for the specified measurement trace.

**Parameter**

Name	Type	Range	Default
<cn>	Integer	1 to 500	1
<mn>	Integer	1 to 50000	1
<value>	Real	Refer to Remarks	0

**Remarks**

<value> indicates the impulse width. It can be any number ranging from 0.6/frequency span to 1.39/frequency span.

**Return Format**

The query returns the impulse width in the Time Domain Setup (TDA) in scientific notation. The unit is s.

**Example**

```
:CALCulate1:MEASure1:TRANSform:TIME:IMPulse:WIDTh 1e-8 /*Sets the
impulse width to 10 ns.*/
:CALCulate1:MEASure1:TRANSform:TIME:IMPulse:WIDTh? /*The
query returns 1.00e-08.*/
```

## 7.31.12 :CALCulate<cn>:MEASure<mn>:TRANSform:TIME:WINDow[:TYPE]

**Syntax**

```
:CALCulate<cn>:MEASure<mn>:TRANSform:TIME:WINDow[:TYPE] <type>
```

```
:CALCulate<cn>:MEASure<mn>:TRANSform:TIME:WINDow[:TYPE]?
```

**Description**

Setup the window function type of the DTF function (DTF) for the specified measurement trace.

Queries the window function type of the DTF function (DTF) for the specified measurement trace.

**Parameter**

Name	Type	Range	Default
<cn>	Integer	1 to 500	1
<mn>	Integer	1 to 50000	1
<type>	Discrete	{RECTangular HANNing HAMMING FLATtop GAUSSian}	RECTangular

**Remarks**

- RECTangular: Rectangular window
- HANNing: Hanning window
- HAMMING: Hamming window
- FLATtop: Flattop window
- GAUSSian: Gaussian window

**Return Format**

The query returns RECT, HANN, HAMM, FLAT, or GAU.

**Example**

```
:CALCulate1:MEASure1:TRANSform:TIME:WINDow HANNing /*Sets the
window function type of the DTF to HANNing.*/
```

```
:CALCulate1:MEASure1:TRANSform:TIME:WINDow? /*The query returns HANN.*/
```

### 7.31.13 :CALCulate<cn>:MEASure<mn>:TRANSform:DTFault:STATe

#### Syntax

```
:CALCulate<cn>:MEASure<mn>:TRANSform:DTFault:STATe <bool>
```

```
:CALCulate<cn>:MEASure<mn>:TRANSform:DTFault:STATe?
```

#### Description

Enables or disables the DTF function for the specified measurement trace.

Queries the on/off status of the DTF function for the specified measurement trace.

#### Parameter

Name	Type	Range	Default
<cn>	Integer	1 to 500	1
<mn>	Integer	1 to 50000	1
<bool>	Bool	{{1 ON}} {{0 OFF}}	0 OFF

#### Remarks

N/A

#### Return Format

The query returns 1 or 0.

#### Example

```
:CALCulate1:MEASure1:TRANSform:DTFault:STATe ON /*Enables the DTF function.*/
:CALCulate1:MEASure1:TRANSform:DTFault:STATe? /*The query returns 1.*/
```

### 7.31.14 :CALCulate<cn>:MEASure<mn>:TRANSform:DTFault:LENGth:UNIT

#### Syntax

```
:CALCulate<cn>:MEASure<mn>:TRANSform:DTFault:LENGth:UNIT <type>
```

```
:CALCulate<cn>:MEASure<mn>:TRANSform:DTFault:LENGth:UNIT?
```

#### Description

Sets the DTF distance unit of the specified measurement trace.

Queries the DTF distance unit of the specified measurement trace.

#### Parameter

Name	Type	Range	Default
<cn>	Integer	1 to 500	1
<mn>	Integer	1 to 50000	1
<type>	Discrete	{METer FEET INCH}	METer

#### Remarks

The parameter <type> can be set to METer, FEET, or INCH.

#### Return Format

The query returns MET, FEET, or NCH.

#### Example

```
:CALCulate1:MEASure1:TRANSform:DTFault:LENGTH:UNIT FEET /*Sets the
distance unit to FEET.*/
:CALCulate1:MEASure1:TRANSform:DTFault:LENGTH:UNIT? /*The query
returns FEET.*/
```

## 7.31.15 :CALCulate<cn>:MEASure<mn>:TRANSform:DTFault:STOP

#### Syntax

```
:CALCulate<cn>:MEASure<mn>:TRANSform:DTFault:STOP <value>
```

```
:CALCulate<cn>:MEASure<mn>:TRANSform:DTFault:STOP?
```

#### Description

Sets the DTF stop distance for the specified measurement trace.

Queries the DTF stop distance for the specified measurement trace.

#### Parameter

Name	Type	Range	Default
<cn>	Integer	1 to 500	1
<mn>	Integer	1 to 50000	1
<value>	Real	Refer to Remarks	0

#### Remarks

The range of <value> is related to the sweep frequency range, the sweep points, and velocity factor.

**Return Format**

The query returns the DTF stop distance for the specified measurement trace. The unit is m.

**Example**

```
:CALCulate1:MEASure1:TRANSform:DTFault:STOP 0.002 /*Sets the DTF
stop distance for measurement trace 1 to 2mm.*/
:CALCulate1:MEASure1:TRANSform:DTFault:STOP? /*The query
returns 2.00e-03.*/
```

## 7.31.16 :CALCulate<cn>:MEASure<mn>:TRANSform:DTFault:LOSS:COAX

**Syntax**

```
:CALCulate<cn>:MEASure<mn>:TRANSform:DTFault:LOSS:COAX <value>
```

```
:CALCulate<cn>:MEASure<mn>:TRANSform:DTFault:LOSS:COAX?
```

**Description**

Sets the DTF cable loss of the specified measurement trace.

Queries the DTF cable loss of the specified measurement trace.

**Parameter**

Name	Type	Range	Default
<cn>	Integer	1 to 500	1
<mn>	Integer	1 to 50000	1
<value>	Real	0 to 1.0e+15	0

**Remarks**

N/A

**Return Format**

The query returns the DTF cable loss in scientific notation. The unit is dB/m.

**Example**

```
:CALCulate1:MEASure1:TRANSform:DTFault:LOSS:COAX 0.2 /*Sets the DTF
cable loss to 0.2 dB/m.*/
:CALCulate1:MEASure1:TRANSform:DTFault:LOSS:COAX? /*The
query returns 2.00e-01.*/
```

## 7.31.17 :CALCulate<cn>:MEASure<mn>:TRANSform:DTFault:VELOCITY

### Syntax

```
:CALCulate<cn>:MEASure<mn>:TRANSform:DTFault:VELOCITY <value>
```

```
:CALCulate<cn>:MEASure<mn>:TRANSform:DTFault:VELOCITY?
```

### Description

Sets the DTF velocity factor for the specified measurement trace.

Queries the DTF velocity factor for the specified measurement trace.

### Parameter

Name	Type	Range	Default
<cn>	Integer	1 to 500	1
<mn>	Integer	1 to 50000	1
<value>	Real	0 to 1	0.66

### Remarks

- Running this command will also modify the velocity factor in DTF and electrical delay.
- This command is valid for the velocity factor for all the channels and ports.

### Return Format

The query returns the velocity factor in scientific notation.

### Example

```
:CALCulate1:MEASure1:TRANSform:DTFault:VELOCITY 0.7 /*Sets the
velocity factor to 0.7.*/
:CALCulate1:MEASure1:TRANSform:DTFault:VELOCITY? /*The
query returns 7.00e-01.*/
```

## 7.31.18 :CALCulate<cn>:MEASure<mn>:TRANSform:COUPLE:PARAMeters

### Syntax

```
:CALCulate<cn>:MEASure<mn>:TRANSform:COUPLE:PARAMeters <num>
```

```
:CALCulate<cn>:MEASure<mn>:TRANSform:COUPLE:PARAMeters?
```

## Description

Sets the time domain transform parameters to be coupled for the specified measurement trace.

Queries the time domain transform parameters to be coupled for the specified measurement trace.

## Parameter

Name	Type	Range	Default
<cn>	Integer	1 to 500	1
<mn>	Integer	1 to 50000	1
<num>	Integer	0 to 63	1

## Remarks

The parameter <value> indicates the time domain transform parameters. The parameter definitions for the different values of <value> are as follows:

- 1: Stimulus values: "Start Time", "Stop Time", "Center Time", and "Span Time" settings in the Time Domain menu.
- 2: State: "Transform State" setting in the Time Domain menu.
- 4: Window function: the "Kaiser Beta" and "Impulse Width" settings in the Time Domain Setup menu.
- 8: Transform type of time domain measurement: "Transform Type" setting in the Time Domain menu.
- 16: marker distance unit: "Units" setting in the Time Domain Setup menu.

If you want to select multiple parameters at one time, add the specified number that it represents the specified parameter. The addition results will be the value of <value>. For example, if you select both transform type of time domain measurement and marker distance unit, then the value of <value> shall be  $8 + 16 = 24$ .

## Return Format

The query returns the time domain transform parameters in integer.

## Example

```
:CALCulate1:MEASure1:TRANSform:COUPle:PARAmeters 2 /*Sets the
transform state parameter to be coupled.*/
:CALCulate1:MEASure1:TRANSform:COUPle:PARAmeters? /*The query
returns 2.*/
```

## 7.32 :CALCulate<cn>:MEASure<mn>:FILTer Commands

The :CALCulate<cn>:MEASure<mn>:FILTer commands are used to set the time domain gating parameters.

The time domain gating function filters the required time domain response and removes the unwanted time domain response, then obtain the required frequency domain characteristics curve of the response through FFT for analysis.

### 7.32.1 :CALCulate<cn>:MEASure<mn>:FILTer:GATE:TIME:STATE

#### Syntax

```
:CALCulate<cn>:MEASure<mn>:FILTer:GATE:TIME:STATE <bool>
```

```
:CALCulate<cn>:MEASure<mn>:FILTer:GATE:TIME:STATE?
```

#### Description

Enables or disables the time gating of the specified measurement trace.

Queries the on/off status of time gating of the specified measurement trace.

#### Parameter

Name	Type	Range	Default
<cn>	Integer	1 to 500	1
<mn>	Integer	1 to 50000	1
<bool>	Bool	{{1 ON}} {{0 OFF}}	0 OFF

#### Remarks

N/A

#### Return Format

The query returns 1 or 0.

#### Example

```
:CALCulate1:MEASure1:FILTer:GATE:TIME:STATE ON /*Enables the time gating.*/
:CALCulate1:MEASure1:FILTer:GATE:TIME:STATE? /*The query returns 1.*/
```

### 7.32.2 :CALCulate<cn>:MEASure<mn>:FILTer:GATE:TIME:START

#### Syntax

```
:CALCulate<cn>:MEASure<mn>:FILTer:GATE:TIME:START <value>
```

```
:CALCulate<cn>:MEASure<mn>:FILTer:GATE:TIME:START?
```

**Description**

Sets the start time in time domain gating of the specified measurement trace.

Queries the start time in time domain gating of the specified measurement trace.

**Parameter**

Name	Type	Range	Default
<cn>	Integer	1 to 500	1
<mn>	Integer	1 to 50000	1
<value>	Real	Refer to Remarks	0

**Remarks**

The start gate time cannot be greater than the stop gate time

(*:CALCulate<cn>:MEASure<mn>:FILTer:GATE:TIME:STOP*).

**Return Format**

The query returns the start gate time in scientific notation. The unit is s.

**Example**

```
:CALCulate1:MEASure1:FILTer:GATE:TIME:START 1e-8 /*Sets the start
gate time to 10 ns.*/
:CALCulate1:MEASure1:FILTer:GATE:TIME:START?           /*The query
returns 1.00e-08.*/
```

**7.32.3 :CALCulate<cn>:MEASure<mn>:FILTer:GATE:TIME:STOP****Syntax**

```
:CALCulate<cn>:MEASure<mn>:FILTer:GATE:TIME:STOP <value>
```

```
:CALCulate<cn>:MEASure<mn>:FILTer:GATE:TIME:STOP?
```

**Description**

Sets the stop time in time domain gating of the specified measurement trace.

Queries the stop time in time domain gating of the specified measurement trace.

**Parameter**

Name	Type	Range	Default
<cn>	Integer	1 to 500	1
<mn>	Integer	1 to 50000	1
<value>	Real	Refer to Remarks	0

**Remarks**

The stop time <value> shall not be less than the start time  
(*:CALCulate<cn>:MEASure<mn>:FILTer:GATE:TIME:START*).

**Return Format**

The query returns the stop time in scientific notation. The unit is s.

**Example**

```
:CALCulate1:MEASure1:FILTer:GATE:TIME:STOP 1e-8 /*Sets the stop
time to 10 ns.*/
:CALCulate1:MEASure1:FILTer:GATE:TIME:STOP? /*The query
returns 1.00e-08.*/
```

**7.32.4 :CALCulate<cn>:MEASure<mn>:FILTer:GATE:TIME:CENTER****Syntax**

```
:CALCulate<cn>:MEASure<mn>:FILTer:GATE:TIME:CENTER <value>
```

```
:CALCulate<cn>:MEASure<mn>:FILTer:GATE:TIME:CENTER?
```

**Description**

Sets the center time in time domain gating of the specified measurement trace.

Queries the center time in time domain gating of the specified measurement trace.

**Parameter**

Name	Type	Range	Default
<cn>	Integer	1 to 500	1
<mn>	Integer	1 to 50000	1
<value>	Real	Refer to Remarks	0

**Remarks**

The center time of the time domain gating is the center value between the start time  
(*:CALCulate<cn>:MEASure<mn>:FILTer:GATE:TIME:START*) and the stop time  
(*:CALCulate<cn>:MEASure<mn>:FILTer:GATE:TIME:STOP*).

**Return Format**

The query returns the center time of the time domain gating in scientific notation.  
The unit is s.

**Example**

```
:CALCulate1:MEASure1:FILTer:GATE:TIME:CENTER 1e-8 /*Sets the center
time to 10 ns.*/
:CALCulate1:MEASure1:FILTer:GATE:TIME:CENTER? /*The
query returns 1.00e-08.*/
```

## 7.32.5 :CALCulate<cn>:MEASure<mn>:FILTer:GATE:TIME:SPAN

### Syntax

```
:CALCulate<cn>:MEASure<mn>:FILTer:GATE:TIME:SPAN <value>
```

```
:CALCulate<cn>:MEASure<mn>:FILTer:GATE:TIME:SPAN?
```

### Description

Sets the span time in time domain gating of the specified measurement trace.

Queries the span time in time domain gating of the specified measurement trace.

### Parameter

Name	Type	Range	Default
<cn>	Integer	1 to 500	1
<mn>	Integer	1 to 50000	1
<value>	Real	Refer to Remarks	0

### Remarks

The span time is the difference between the stop gate

(*:CALCulate<cn>:MEASure<mn>:FILTer:GATE:TIME:START*) time and start gate time

(*:CALCulate<cn>:MEASure<mn>:FILTer:GATE:TIME:STOP*) in the window.

### Return Format

The query returns the span time in scientific notation. The unit is s.

### Example

```
:CALCulate1:MEASure1:FILTer:GATE:TIME:SPAN 1e-8 /*Sets the span
time to 10 ns.*/
:CALCulate1:MEASure1:FILTer:GATE:TIME:SPAN? /*The query
returns 1.00e-08.*/
```

## 7.32.6 :CALCulate<cn>:MEASure<mn>:FILTer:GATE:TIME:SHAPE

### Syntax

```
:CALCulate<cn>:MEASure<mn>:FILTer:GATE:TIME:SHAPE <type>
```

```
:CALCulate<cn>:MEASure<mn>:FILTer:GATE:TIME:SHAPE?
```

### Description

Sets the gate shape in time domain gating of the specified measurement trace.

Queries the gate shape in time domain gating of the specified measurement trace.

**Parameter**

Name	Type	Range	Default
<cn>	Integer	1 to 500	1
<mn>	Integer	1 to 50000	1
<type>	Discrete	{MAXimum WIDE NORMal MINimum}	MAX

**Remarks**

- MAXimum: Max. The minimum gate span is 25.4/frequency span.
- WIDE: Width. The minimum gate span is 8.8/frequency span.
- NORMal: Normal. The minimum gate span is 5.6/frequency span.
- MINimum: Min. The minimum gate span is 2.8/frequency span.

**Return Format**

The query returns MAX, WIDE, NORM, or MIN.

**Example**

```
:CALCulate1:MEASure1:FILTer:GATE:TIME:SHAPE ON /*Sets the gate
shape to WIDE.*/
:CALCulate1:MEASure1:FILTer:GATE:TIME:SHAPE ? /*The query returns
WIDE.*/
```

## 7.32.7 :CALCulate<cn>:MEASure<mn>:FILTer:GATE:COUPlE:PARa meters

**Syntax**

```
:CALCulate<cn>:MEASure<mn>:FILTer:GATE:COUPlE:PARAmeters <value>
:CALCulate<cn>:MEASure<mn>:FILTer:GATE:COUPlE:PARAmeters?
```

**Description**

Sets the time domain gating parameters to be coupled for the specified measurement trace.

Queries the time domain gating parameters to be coupled for the specified measurement trace.

**Parameter**

Name	Type	Range	Default
<cn>	Integer	1 to 500	1

Name	Type	Range	Default
<mn>	Integer	1 to 50000	1
<value>	Real	Refer to Remarks	13

### Remarks

The definitions for the gating parameters are as follows:

- 1: gating stimulus (start time, stop time, center time, and span time)
- 2: gating state (ON/OFF)
- 4: gate shape (Min, Normal, Width, Max)
- 8: gate type (Band Pass, Notch)

If you want to select multiple parameters at one time, add the specified number that it represents the specified parameter. The addition results will be the value of <value>.

### Return Format

The query returns the time domain gating parameters in integer.

### Example

```
:CALCulate1:MEASure1:FILTer:GATE:COUPle:PARAmeters 2 /*Sets the
time domain gating parameter to be coupled to gating state.*/
:CALCulate1:MEASure1:FILTer:GATE:COUPle:PARAmeters? /*The query
returns 2.*/
```

## 7.33 :CALCulate<cn>:FSIMulator Commands

The :CALCulate<cn> :FSIMulator commands are used to set and query the calibration fixture function parameters.

The fixture is used to simulate the electrical characteristics of the fixture with the software-based math model.

### 7.33.1 :CALCulate<cn>:FSIMulator:STATe

#### Syntax

```
:CALCulate<cn>:FSIMulator:STATe? <bool>
```

```
:CALCulate<cn>:FSIMulator:STATe?
```

#### Description

Enables or disables the de-embedding for all ports on the specified channel.

Queries the on/off status of the de-embedding for all ports on the specified port.

**Parameter**

Name	Type	Range	Default
<cn>	Integer	1 to 500	1
<bool>	Bool	{{1 ON}}{0 OFF}}	0 OFF

**Remarks**

The de-embedding function controls the de-embedding for port match, port reference impedance conversion, and port de-embedding. It does not affect the port extension (*:SENSe<cn>:CORRection:EXTEnsion:STATE*).

**Return Format**

The query returns 1 or 0.

**Example**

```
:CALCulate1:FSIMulator1:STATE ON /*Enables de-embedding for all
ports.*/
:CALCulate1:FSIMulator1:STATE? /*The query returns 1.*/
```

## 7.33.2 :CALCulate<cn>:FSIMulator:SNP:EXTRapolate

**Syntax**

```
:CALCulate<cn>:FSIMulator:SNP:EXTRapolate? <bool>
```

```
:CALCulate<cn>:FSIMulator:SNP:EXTRapolate?
```

**Description**

Enables or disables extrapolation for the SNP file.

Queries the on/off status of the extrapolation for the SNP file.

**Parameter**

Name	Type	Range	Default
<cn>	Integer	1 to 500	1
<bool>	Bool	{{1 ON}}{0 OFF}}	0 OFF

**Remarks**

N/A

**Return Format**

The query returns 1 or 0.

**Example**

```
:CALCulate1:FSIMulator1:SNP:EXTRapolate ON /*Enables extrapolation
for the SNP file.*/
:CALCulate1:FSIMulator1:SNP:EXTRapolate? /*The query returns 1.*/
```

**7.33.3 :CALCulate<cn>:FSIMulator:SENDEd:PMCircuit:STATE****Syntax**

```
:CALCulate<cn>:FSIMulator:SENDEd:PMCircuit:STATE <bool>
:CALCulate<cn>:FSIMulator:SENDEd:PMCircuit:STATE?
```

**Description**

Enables or disables the port match function.

Queries the on/off status of the port match.

**Parameter**

Name	Type	Range	Default
<cn>	Integer	1 to 500	1
<bool>	Bool	{{1 ON}} {{0 OFF}}	0 OFF

**Remarks**

This command will affect all the measurements on the specified channel.

**Return Format**

The query returns 1 or 0.

**Example**

```
:CALCulate1:FSIMulator1:STATE ON /*Enables port match.*/
:CALCulate1:FSIMulator1:STATE? /*The query returns 1.*/
```

**7.33.4 :CALCulate<cn>:FSIMulator:SENDEd:PMCircuit:PORT<pn>  
>[:TYPE]****Syntax**

```
:CALCulate<cn>:FSIMulator:SENDEd:PMCircuit:PORT<pn>[:TYPE] <type>
:CALCulate<cn>:FSIMulator:SENDEd:PMCircuit:PORT<pn>[:TYPE]?
```

**Description**

Sets whether to load a n-port matching circuit model for the specified port.

Queries whether to load a n-port matching circuit model for the specified port.

**Parameter**

Name	Type	Range	Default
<cn>	Integer	1 to 500	1
<pn>	Integer	Refer to Remarks	1
<type>	Discrete	{NONE USER}	NONE

**Remarks**

- For DNA6082-R, DNA6142-R, DNA6202-R, and DNA6262-R, <pn> can be set to 1 or 2.
- For DNA6084-R, DNA6144-R, DNA6204-R, and DNA6264-R, <pn> can be set to 1, 2, 3, or 4.

<type> indicates the port matching circuit model selected for the specified port. It can be set to NONE or USER.

- NONE: selects "None", indicating no circuit model is available to choose.
- USER: selects "Match SNP File", indicating loading a "\*.SNP" file. You need to specify an associated \*.snp file first.

**Return Format**

The query returns NONE or USER.

**Example**

```
:CALCulate1:FSIMulator:SENDEd:PMCircuit:PORT1 USER /*Sets the port
matching circuit model selected for Port1 to USER.*/
:CALCulate1:FSIMulator:SENDEd:PMCircuit:PORT1? /*The
query returns USER.*/
```

### 7.33.5 :CALCulate<cn>:FSIMulator:SENDEd:PMCircuit:PORT<pn> :USER:FILEname

**Syntax**

```
:CALCulate<cn>:FSIMulator:SENDEd:PMCircuit:PORT:USER<pn>:USER:FILEname <string>
```

```
:CALCulate<cn>:FSIMulator:SENDEd:PMCircuit:PORT:USER<pn>:USER:FILEname?
```

## Description

Sets the filename (suffixed with \*.snp, n indicates the number of ports) of the circuit model to be used for port match.

Queries the filename of the circuit model to be used for port match.

## Parameter

Name	Type	Range	Default
<cn>	Integer	1 to 500	1
<pn>	Integer	Refer to Remarks	1
<string>	ASCII String	-	-

## Remarks

- For DNA6082-R, DNA6142-R, DNA6202-R, and DNA6262-R, <pn> can be set to 1 or 2.
- For DNA6084-R, DNA6144-R, DNA6204-R, and DNA6264-R, <pn> can be set to 1, 2, 3, or 4.

The circuit model will be applied when the `:CALCulate<cn>:FSIMulator:SENDED:PMCircuit:PORT<pn>[:TYPE]` is configured with "USER" and the filename is specified with this command. This command will affect all the measurements on the channel.

The filename shall contain the path and ensure that the file exists in the specified path.

## Return Format

The query returns the filename of the circuit model to be used for port match in strings.

## Example

```
:CALCulate1:FSIMulator:SENDED:PMCircuit:PORT1:USER:FILENAME /data/
UserData/mydata2.s2p /*Sets the filename of the circuit model to be
used for port match to /data/UserData/mydata2.s2p.*/*
:CALCulate1:FSIMulator:SENDED:PMCircuit:PORT1:USER:FILENAME?
/*The query returns /data/UserData/mydata2.s2p.*/*
```

### 7.33.6 :CALCulate<cn>:FSIMulator:SENDEd:PMCircuit:PORT<pn>:PARAmeters:C

#### Syntax

```
:CALCulate<cn>:FSIMulator:SENDEd:PMCircuit:PORT<pn>:PARAmeters:C
<value>
```

```
:CALCulate<cn>:FSIMulator:SENDEd:PMCircuit:PORT<pn>:PARAmeters:C?
```

#### Description

Sets the value for the C (Capacitance) circuit element for a port matching circuit model to simulate on the specified port.

Queries the value for the C (Capacitance) circuit element for a port matching circuit model to simulate on the specified port.

#### Parameter

Name	Type	Range	Default
<cn>	Integer	1 to 500	1
<pn>	Integer	Refer to Remarks	1
<value>	Real	-1E18 to 1E18	0

#### Remarks

- For DNA6082-R, DNA6142-R, DNA6202-R, and DNA6262-R, <pn> can be set to 1 or 2.
- For DNA6084-R, DNA6144-R, DNA6204-R, and DNA6264-R, <pn> can be set to 1, 2, 3, or 4.

To set up a port matching circuit model simulation on a specified port, perform the following three steps.

1. Run the `:CALCulate<cn>:FSIMulator:SENDEd:PMCircuit:PORT<pn>[:TYPE]` command to select the port matching circuit model to simulate.
2. Set the values for R (Resistance), G (Conductance), C (Capacitance), and L (Inductance) corresponding to the selected port matching circuit model.
3. Run the `:CALCulate<cn>:FSIMulator:SENDEd:PMCircuit:STATE` command to enable the port match.

**Return Format**

The query returns the C value in scientific notation. The unit is Farad (F).

**Example**

```
:CALCulate1:FSIMulator:SENDEd:PMCircuit:PORT1:PARAmeters:C 0.00003 /
*Sets the C value to 0.00003F.* /
:CALCulate1:FSIMulator:SENDEd:PMCircuit:PORT1:PARAmeters:C? /*The
query returns 3.00e-05.* /
```

### 7.33.7 :CALCulate<cn>:FSIMulator:SENDEd:PMCircuit:PORT<pn>:PARAmeters:G

**Syntax**

```
:CALCulate<cn>:FSIMulator:SENDEd:PMCircuit:PORT<pn>:PARAmeters:G
<value>
```

```
:CALCulate<cn>:FSIMulator:SENDEd:PMCircuit:PORT<pn>:PARAmeters:G?
```

**Description**

Sets the value for the G (Conductance) circuit element for a port matching circuit model to simulate on the specified port.

Queries the value for the G (Conductance) circuit element for a port matching circuit model to simulate on the specified port.

**Parameter**

Name	Type	Range	Default
<cn>	Integer	1 to 500	1
<pn>	Integer	Refer to Remarks	1
<value>	Real	-1E18 to 1E18	0

**Remarks**

- For DNA6082-R, DNA6142-R, DNA6202-R, and DNA6262-R, <pn> can be set to 1 or 2.
- For DNA6084-R, DNA6144-R, DNA6204-R, and DNA6264-R, <pn> can be set to 1, 2, 3, or 4.

To set up a port matching circuit model simulation on a specified port, perform the following three steps.

1. Run the `:CALCulate<cn>:FSIMulator:SENDEd:PMCircuit:PORT<pn>[:TYPE]` command to select the port matching circuit model to simulate.
2. Set the values for R (Resistance), G (Conductance), C (Capacitance), and L (Inductance) corresponding to the selected port matching circuit model.
3. Run the `:CALCulate<cn>:FSIMulator:SENDEd:PMCircuit:STATe` command to enable the port match.

### Return Format

The query returns the G value in scientific notation. The unit is Siemens (S).

### Example

```
:CALCulate1:FSIMulator:SENDEd:PMCircuit:PORT1:PARAMeters:G 0.00003 /*
*Sets the G value to 0.00003 S.*/
:CALCulate1:FSIMulator:SENDEd:PMCircuit:PORT1:PARAMeters:G? /*The
query returns 3.00e-05.*/
```

## 7.33.8 :CALCulate<cn>:FSIMulator:SENDEd:PMCircuit:PORT<pn>:PARAMeters:L

### Syntax

```
:CALCulate<cn>:FSIMulator:SENDEd:PMCircuit:PORT<pn>:PARAMeters:L
<value>
```

```
:CALCulate<cn>:FSIMulator:SENDEd:PMCircuit:PORT<pn>:PARAMeters:L?
```

### Description

Sets the value for the L (Inductance) circuit element for a port matching circuit model to simulate on the specified port.

Queries the value for the L (Inductance) circuit element for a port matching circuit model to simulate on the specified port.

### Parameter

Name	Type	Range	Default
<cn>	Integer	1 to 500	1
<pn>	Integer	Refer to Remarks	1
<value>	Real	-1E18 to 1E18	0

**Remarks**

- For DNA6082-R, DNA6142-R, DNA6202-R, and DNA6262-R, <pn> can be set to 1 or 2.
- For DNA6084-R, DNA6144-R, DNA6204-R, and DNA6264-R, <pn> can be set to 1, 2, 3, or 4.

To set up a port matching circuit model simulation on a specified port, perform the following three steps.

1. Run the `:CALCulate<cn>:FSIMulator:SENDEd:PMCircuit:PORT<pn>[:TYPE]` command to select the port matching circuit model to simulate.
2. Set the values for R (Resistance), G (Conductance), C (Capacitance), and L (Inductance) corresponding to the selected port matching circuit model.
3. Run the `:CALCulate<cn>:FSIMulator:SENDEd:PMCircuit:STATe` command to enable the port match.

**Return Format**

The query returns the L value in scientific notation. The unit is Henry (*H*).

**Example**

```
:CALCulate1:FSIMulator:SENDEd:PMCircuit:PORT1:PARAmeters:L 0.00003 /*
*Sets the L value to 0.00003H.*/
:CALCulate1:FSIMulator:SENDEd:PMCircuit:PORT1:PARAmeters:L? /*The
query returns 3.00e-05.*/
```

### 7.33.9 :CALCulate<cn>:FSIMulator:SENDEd:PMCircuit:PORT<pn>:PARAmeters:R

**Syntax**

```
:CALCulate<cn>:FSIMulator:SENDEd:PMCircuit:PORT<pn>:PARAmeters:R
<value>
```

```
:CALCulate<cn>:FSIMulator:SENDEd:PMCircuit:PORT<pn>:PARAmeters:R?
```

**Description**

Sets the value for the R (Resistance) circuit element for a port matching circuit model to simulate on the specified port.

Queries the value for the R (Resistance) circuit element for a port matching circuit model to simulate on the specified port.

**Parameter**

Name	Type	Range	Default
<cn>	Integer	1 to 500	1
<pn>	Integer	Refer to Remarks	1
<value>	Real	-1E18 to 1E18	0

**Remarks**

- For DNA6082-R, DNA6142-R, DNA6202-R, and DNA6262-R, <pn> can be set to 1 or 2.
- For DNA6084-R, DNA6144-R, DNA6204-R, and DNA6264-R, <pn> can be set to 1, 2, 3, or 4.

To set up a port matching circuit model simulation on a specified port, perform the following three steps.

1. Run the `:CALCulate<cn>:FSIMulator:SENDEd:PMCircuit:PORT<pn>[:TYPE]` command to select the port matching circuit model to simulate.
2. Set the values for R (Resistance), G (Conductance), C (Capacitance), and L (Inductance) corresponding to the selected port matching circuit model.
3. Run the `:CALCulate<cn>:FSIMulator:SENDEd:PMCircuit:STATe` command to enable the port match.

**Return Format**

The query returns the R value in scientific notation. The unit is ohm ( $\Omega$ ).

**Example**

```
:CALCulate1:FSIMulator:SENDEd:PMCircuit:PORT1:PARAMeters:R 0.00003 /*
*Sets the R value to 0.00003  $\Omega$ .*/
:CALCulate1:FSIMulator:SENDEd:PMCircuit:PORT1:PARAMeters:R? /*The
query returns 3.00e-05.*/
```

### 7.33.10 :CALCulate<cn>:FSIMulator:SENDEd:PMCircuit:PORT<pn>:SNP:RANGe?

**Syntax**

```
:CALCulate<cn>:FSIMulator:SENDEd:PMCircuit:PORT<pn>:SNP:RANGe?
```

**Description**

Queries the port frequency range of the match SNP file (suffixed with \*.snp, n indicates the number of ports).

**Parameter**

Name	Type	Range	Default
<cn>	Integer	1 to 500	1
<pn>	Integer	Refer to Remarks	1

**Remarks**

- For DNA6082-R, DNA6142-R, DNA6202-R, and DNA6262-R, <pn> can be set to 1 or 2.
- For DNA6084-R, DNA6144-R, DNA6204-R, and DNA6264-R, <pn> can be set to 1, 2, 3, or 4.

**Return Format**

Queries the port frequency range of the match SNP file (suffixed with \*.snp, n indicates the number of ports) in strings.

**Example**

N/A

## 7.33.11 :CALCulate<cn>:FSIMulator:SENDEd:DEEMbed:STATE

**Syntax**

```
:CALCulate<cn>:FSIMulator:SENDEd:DEEMbed:STATE <bool>
```

```
:CALCulate<cn>:FSIMulator:SENDEd:DEEMbed:STATE?
```

**Description**

Enables or disables the port de-embedding function.

Queries the on/off status of the port de-embedding function.

**Parameter**

Name	Type	Range	Default
<cn>	Integer	1 to 500	1
<bool>	Bool	{{1 ON}}{0 OFF}}	0 OFF

**Remarks**

N/A

**Return Format**

The query returns 1 or 0.

**Example**

```
:CALCulate1:FSIMulator1:STATE ON /*Enables the port de-embedding
function.*/
:CALCulate1:FSIMulator1:STATE? /*The query returns 1.*/
```

## 7.33.12 :CALCulate<cn>:FSIMulator:SENDEd:DEEMbed:PORT<pn>[:TYPE]

**Syntax**

```
:CALCulate<cn>:FSIMulator:SENDEd:DEEMbed:PORT<pn>[:TYPE] <type>
```

```
:CALCulate<cn>:FSIMulator:SENDEd:DEEMbed:PORT<pn>[:TYPE]?
```

**Description**

Sets whether to load a n-port de-embed circuit model for the specified port.

Queries whether to load a n-port de-embed circuit model for the specified port.

**Parameter**

Name	Type	Range	Default
<cn>	Integer	1 to 500	1
<pn>	Integer	Refer to Remarks	1
<type>	Discrete	{NONE USER}	NONE

**Remarks**

- For DNA6082-R, DNA6142-R, DNA6202-R, and DNA6262-R, <pn> can be set to 1 or 2.
- For DNA6084-R, DNA6144-R, DNA6204-R, and DNA6264-R, <pn> can be set to 1, 2, 3, or 4.

The parameter &lt;type&gt; can be set to NONE or USER.

- NONE:** selects "None", indicating no circuit model is available to choose.

- **USER:** loads the user-defined SNP file as the circuit model for the port. Note that you should run the `CALC:FSIM:SEND:DEEM:PORT1:USER:FILENAME` command to specify an associated \*.snp file first.

#### Return Format

The query returns NONE or USER.

#### Example

```
:CALCulate1:FSIMulator:SENDEd:DEEMbed:PORT1 NONE /*Sets no circuit
model for Port1.*/
:CALCulate1:FSIMulator:SENDEd:DEEMbed:PORT1? /*The query returns
NONE.*/
```

### 7.33.13 :CALCulate<cn>:FSIMulator:SENDEd:DEEMbed:PORT<pn>:USER:FILENAME

#### Syntax

```
:CALCulate<cn>:FSIMulator:SENDEd:DEEMbed:PORT<pn>:USER:FILENAME
<file_name>
```

```
:CALCulate<cn>:FSIMulator:SENDEd:DEEMbed:PORT<pn>:USER:FILENAME?
```

#### Description

Sets the filename (suffixed with \*.snp, n indicates the number of ports) of the circuit model to be used for port de-embedding.

Queries the filename (suffixed with \*.s2p, n indicates the number of ports) of the circuit model to be used for port de-embedding.

#### Parameter

Name	Type	Range	Default
<cn>	Integer	1 to 500	1
<pn>	Integer	Refer to Remarks	1
<file_name>	ASCII String	-	-

#### Remarks

The circuit model will be applied when the `:CALCulate<cn>:FSIMulator:SENDEd:DEEMbed:PORT<pn>[:TYPE]` is configured with "USER" and the filename is specified with this command. This command will affect all the measurements on the channel.

- For DNA6082-R, DNA6142-R, DNA6202-R, and DNA6262-R, <pn> can be set to 1 or 2.
- For DNA6084-R, DNA6144-R, DNA6204-R, and DNA6264-R, <pn> can be set to 1, 2, 3, or 4.

The filename shall contain the path and ensure that the file exists in the specified path.

#### Return Format

The query returns the filename of the circuit model to be used for port de-embedding in strings.

#### Example

```
:CALCulate1:FSIMulator:SENDEd:DEEMbed:PORT1 /data/UserData/mydata2.s2p /*Sets the filename of the circuit model to be used for port de-embedding to /data/UserData/mydata2.s2p.*/
:CALCulate1:FSIMulator:SENDEd:DEEMbed:PORT1:USER:FILENAME?
/*The query returns /data/UserData/mydata2.s2p.*/
```

### 7.33.14 :CALCulate<cn>:FSIMulator:SENDEd:DEEMbed:PORT<pn>:SNP:REVerse

#### Syntax

```
:CALCulate<cn>:FSIMulator:SENDEd:DEEMbed:PORT<pn>:SNP:REVerse <bool>
```

```
:CALCulate<cn>:FSIMulator:SENDEd:DEEMbed:PORT<pn>:SNP:REVerse?
```

#### Description

Enables or disables reversing adapter ports on a n-port fixture or adapter to be de-embedded.

Queries whether to reverse adapter ports on a n-port fixture or adapter to be de-embedded.

#### Parameter

Name	Type	Range	Default
<cn>	Integer	1 to 500	1
<pn>	Integer	Refer to Remarks	1
<bool>	Bool	{{1 ON}} {0 OFF}}	0 OFF

**Remarks**

- For DNA6082-R, DNA6142-R, DNA6202-R, and DNA6262-R, <pn> can be set to 1 or 2.
- For DNA6084-R, DNA6144-R, DNA6204-R, and DNA6264-R, <pn> can be set to 1, 2, 3, or 4.

When <bool> is set to ON or 1, it indicates that reversing adapter port is enabled; when <bool> is set to OFF or 0, it indicates that reversing adapter port is disabled.

**Return Format**

The query returns 1 or 0.

**Example**

```
:CALCulate1:FSIMulator:SENDED:DEEMbed:PORT1:SNP:REVerse ON /
*Enables reversing adapter ports for Port1.*
:CALCulate1:FSIMulator:SENDED:DEEMbed:PORT1:SNP:REVerse? /*The
query returns 1.*
```

### 7.33.15 :CALCulate<cn>:FSIMulator:SENDED:DEEMbed:PORT<pn>:SNP:RANGE?

**Syntax**

```
:CALCulate<cn>:FSIMulator:SENDED:DEEMbed:PORT<pn>:SNP:RANGE?
```

**Description**

Queries the port frequency range of the user defined SNP file (suffixed with \*.snp, n indicates the number of ports).

**Parameter**

Name	Type	Range	Default
<cn>	Integer	1 to 500	1
<pn>	Integer	Refer to Remarks	1

**Remarks**

- For DNA6082-R, DNA6142-R, DNA6202-R, and DNA6262-R, <pn> can be set to 1 or 2.
- For DNA6084-R, DNA6144-R, DNA6204-R, and DNA6264-R, <pn> can be set to 1, 2, 3, or 4.

**Return Format**

The query returns the port frequency range of the user defined SNP file (\*.snp) in strings.

**Example**

N/A

**7.33.16 :CALCulate<cn>:FSIMulator:SENDEd:ZCONversion:STATE****Syntax**

```
:CALCulate<cn>:FSIMulator:SENDEd:ZCONversion:STATE <bool>
```

```
:CALCulate<cn>:FSIMulator:SENDEd:ZCONversion:STATE?
```

**Description**

Enables or disables the port impedance conversion.

Queries the on/off status of the port impedance conversion.

**Parameter**

Name	Type	Range	Default
<cn>	Integer	1 to 500	1
<bool>	Bool	{{1 ON}} {{0 OFF}}	0 OFF

**Remarks**

This command will affect all the measurements on the specified channel.

**Return Format**

The query returns 1 or 0.

**Example**

```
:CALCulate1:FSIMulator1:STATE ON /*Enables port impedance
conversion.*/
:CALCulate1:FSIMulator1:STATE? /*The query returns 1.*/
```

**7.33.17 :CALCulate<cn>:FSIMulator:SENDEd:ZCONversion:PORT<pn>:REAL****Syntax**

```
:CALCulate<cn>:FSIMulator:SENDEd:ZCONversion:PORT<pn>:REAL <value>
```

```
:CALCulate<cn>:FSIMulator:SENDEd:ZCONversion:PORT<pn>:REAL?
```

**Description**

Sets the real part of the impedance of the specified single-ended port.

Queries the real part of the impedance of the specified single-ended port.

**Parameter**

Name	Type	Range	Default
<cn>	Integer	1 to 500	1
<pn>	Integer	Refer to Remarks	1
<value>	Real	0 to 1E7	50 $\Omega$

**Remarks**

This command will affect all the measurements on the specified channel.

- For DNA6082-R, DNA6142-R, DNA6202-R, and DNA6262-R, <pn> can be set to 1 or 2.
- For DNA6084-R, DNA6144-R, DNA6204-R, and DNA6264-R, <pn> can be set to 1, 2, 3, or 4.

**Return Format**

The query returns the real value of the specified single-ended port in scientific notation. The unit is  $\Omega$ .

**Example**

```
:CALCulate1:FSIMulator:SENDEd:ZCONversion:PORT1:REAL 10 /*Sets the
real part of the Port 1 impedance to 10  $\Omega$ .*/
:CALCulate1:FSIMulator:SENDEd:ZCONversion:PORT1:REAL? /*The query
returns 1.00e+01.*/
```

## 7.33.18 :CALCulate<cn>:FSIMulator:SENDEd:ZCONversion:PORT<pn>:IMAG

**Syntax**

```
:CALCulate<cn>:FSIMulator:SENDEd:ZCONversion:PORT<pn>:IMAG <value>
```

```
:CALCulate<cn>:FSIMulator:SENDEd:ZCONversion:PORT<pn>:IMAG?
```

**Description**

Sets the Imaginary part of the impedance of the specified single-ended port.

Queries the Imaginary part of the impedance of the specified single-ended port.

**Parameter**

Name	Type	Range	Default
<cn>	Integer	1 to 500	1
<pn>	Integer	Refer to Remarks	1
<value>	Real	-1E18 to 1E18	0

**Remarks**

This command will affect all the measurements on the specified channel.

- For DNA6082-R, DNA6142-R, DNA6202-R, and DNA6262-R, <pn> can be set to 1 or 2.
- For DNA6084-R, DNA6144-R, DNA6204-R, and DNA6264-R, <pn> can be set to 1, 2, 3, or 4.

**Return Format**

The query returns the Imaginary part of the impedance of the specified single-ended port in scientific notation. The unit is  $\Omega$ .

**Example**

```
:CALCulate1:FSIMulator:SENDED:ZCONversion:PORT1:IMAG 10 /*Sets the
Imaginary part of the Port 1 impedance to 10  $\Omega$ .*/
:CALCulate1:FSIMulator:SENDED:ZCONversion:PORT1:IMAG? /*The query
returns 1.00e+01.*/
```

### 7.33.19 :CALCulate<cn>:FSIMulator:SENDED:ZCONversion:PORT<pn>:Z0[R]

**Syntax**

```
:CALCulate<cn>:FSIMulator:SENDED:ZCONversion:PORT<pn>:Z0[R] <value>
```

```
:CALCulate<cn>:FSIMulator:SENDED:ZCONversion:PORT<pn>:Z0[R]?
```

**Description**

Sets the Real part of the impedance of the specified single-ended port. The imaginary part will be automatically set to 0.

Queries the Real part of the impedance of the specified single-ended port.

**Parameter**

Name	Type	Range	Default
<cn>	Integer	1 to 500	1

Name	Type	Range	Default
<pn>	Integer	Refer to Remarks	1
<value>	Real	0 to 1E7	50

### Remarks

This command will affect all the measurements on the specified channel.

- For DNA6082-R, DNA6142-R, DNA6202-R, and DNA6262-R, <pn> can be set to 1 or 2.
- For DNA6084-R, DNA6144-R, DNA6204-R, and DNA6264-R, <pn> can be set to 1, 2, 3, or 4.

To set the both the real part and imaginary part of the impedance, run the `:CALCulate<cn>:FSIMulator:SENDED:ZCONversion:PORT<pn>:REAL` command and the `:CALCulate<cn>:FSIMulator:SENDED:ZCONversion:PORT<pn>:IMAG` command respectively.

### Return Format

The query returns the Real part of the specified single-ended port in scientific notation. The unit is  $\Omega$ .

### Example

```
:CALCulate1:FSIMulator:SENDED:ZCONversion:PORT1:Z0 10 /*Sets the
Real part of the impedance on Port 1 to 10  $\Omega$ .*/
:CALCulate1:FSIMulator:SENDED:ZCONversion:PORT1:Z0? /*The query
returns 1.00e+01.*/
```

## 7.33.20 :CALCulate<cn>:FSIMulator:DRAft:EXTension:PORT<pn>:VELOCITY:FACTOR

### Syntax

```
:CALCulate<cn>:FSIMulator:DRAft:EXTension:PORT<pn>:VELOCITY:FACTOR
<value>
```

```
:CALCulate<cn>:FSIMulator:DRAft:EXTension:PORT<pn>:VELOCITY:FACTOR?
```

### Description

Sets the velocity factor for the specified port in port extensions.

Queries the velocity factor for the specified port in port extensions.

**Parameter**

Name	Type	Range	Default
<cn>	Integer	1 to 500	1
<pn>	Integer	Refer to Remarks	1
<value>	Real	0 to 1	0.66

**Remarks**

- For DNA6082-R, DNA6142-R, DNA6202-R, and DNA6262-R, <pn> can be set to 1 or 2.
- For DNA6084-R, DNA6144-R, DNA6204-R, and DNA6264-R, <pn> can be set to 1, 2, 3, or 4.

**Return Format**

The query returns the velocity factor for port extension in scientific notation.

**Example**

```
:CALCulate1:FSIMulator:DRAft:EXTension:PORT1:VELOCITY:FACTOR 0.7 /
*Sets the velocity factor to 0.7.*
:CALCulate1:FSIMulator:DRAft:EXTension:PORT1:VELOCITY:FACTOR?
/*The query returns 7.00e-01.*/
```

**7.33.21 :CALCulate<cn>:FSIMulator:BALun:DEVICE****Syntax**

```
:CALCulate<cn>:FSIMulator:BALun:DEVICE <char>
```

```
:CALCulate<cn>:FSIMulator:BALun:DEVICE?
```

**Description**

Sets the DUT balanced topology for the specified channel.

Queries the DUT balanced topology for the specified channel.

**Parameter**

Name	Type	Range	Default
<cn>	Integer	1 to 500	1
<char>	Strings	BALanced BBALanced  BALSende SBALanced  SSBalanced BSSende CUST	BALanced

**Remarks**

- BALanced: Single balanced port.
- BBALanced: Balanced port - Balanced port
- BALSended: Balanced port - Single-ended port
- SBALanced: Single-ended port - Balanced port
- SSBalanced: Single-ended port - Single-ended port - Balanced port
- BSSended: Balanced port - Single-ended port - Single-ended port
- CUST: four-port (or above) topology

**Return Format**

The query returns BALanced, BBALanced, BALSended, SBALanced, SSBalanced, BSSended, or CUST.

The query returns BAL, BBAL, BALS, SBAL, SSB, BSS, or CUST.

**Example**

```
:CALCulate1:FSIMulator:BALun:DEVIce BBALanced /*Sets the DUT
balanced topology to BBAL*/
:CALCulate1:FSIMulator:BALun:DEVIce? /*The query returns
BBALanced.*/
```

## 7.33.22 :CALCulate<cn>:FSIMulator:BALun:TOPology:BALanced[:P PORTs]

**Syntax**

```
:CALCulate<cn>:FSIMulator:BALun:TOPology:BALanced[:PPORTs]
<p1Pos>,<p1Neg>
:CALCulate<cn>:FSIMulator:BALun:TOPology:BALanced[:PPORTs]?
```

**Description**

Sets the port to which the BAL topology is mapped.

Queries the port to which the BAL topology is mapped.

**Parameter**

Name	Type	Range	Default
<cn>	Integer	1 to 500	1
<p1Pos>	Integer	1 to 199	1
<p1Neg>	Integer	1 to 199	1

**Remarks**

- <p1Pos>: indicates the physical port connected to the balanced logical port 1 via the positive line.
- <p1Neg>: indicates the physical port connected to the balanced logical port 1 via the negative line.

**Return Format**

The query returns the port number that is connected based on the BAL topology, separated by commas.

**Example**

```
:CALCulate1:FSIMulator:BALun:TOPology:BALanced 1,2 /*Sets the port
number to which the BAL topology maps to 1,2.*/
:CALCulate1:FSIMulator:BALun:TOPology:BALanced? /*The query returns
1,2.*/
```

### 7.33.23 :CALCulate<cn>:FSIMulator:BALun:TOPology:BBALanced[:PPORts]

**Syntax**

```
:CALCulate<cn>:FSIMulator:BALun:TOPology:BBALanced[:PPORts]
<p1Pos>,<p1Neg>,<p2Pos>,<p2Neg>
:CALCulate<cn>:FSIMulator:BALun:TOPology:BBALanced[:PPORts]?
```

**Description**

Sets the port mapping to BAL-BAL topology.

Queries the port mapping for the BAL-BAL topology.

**Parameter**

Name	Type	Range	Default
<cn>	Integer	1 to 500	1
<p1Pos>	Integer	1 to 199	1
<p1Neg>	Integer	1 to 199	1
<p2Pos>	Integer	1 to 199	1
<p2Neg>	Integer	1 to 199	1

**Remarks**

- <p1Pos>: indicates the physical port connected to the balanced logical port 1 via the positive line.
- <p1Neg>: indicates the physical port connected to the balanced logical port 1 via the negative line.
- <p2Pos>: indicates the physical port connected to the balanced logical port 2 via the positive line.
- <p2Neg>: indicates the physical port connected to the balanced logical port 2 via the negative line.

**Return Format**

The query returns the port number that is connected based on the BAL-BAL topology, separated by commas.

**Example**

```
:CALCulate1:FSIMulator:BALun:TOPology:BBALanced 1,2,3,4 /*Sets the
port number to which the BAL-BAL topology maps to 1, 2, 3, 4.*/
:CALCulate1:FSIMulator:BALun:TOPology:BBALanced? /*The query
returns 1, 2, 3, 4.*/
```

## 7.33.24 :CALCulate<cn>:FSIMulator:BALun:TOPology:BSSended[:P PORTs]

**Syntax**

```
:CALCulate<cn>:FSIMulator:BALun:TOPology:BSSended[:P  
PORTs]  
<bPos>,<bNeg>,<se1>,<se12>  
:CALCulate<cn>:FSIMulator:BALun:TOPology:BSSended[:P  
PORTs]?
```

**Description**

Sets the port to which the BAL-SE-SE topology is mapped.

Queries the port to which the BAL-SE-SE topology is mapped.

**Parameter**

Name	Type	Range	Default
	Integer	1 to 500	1
bPos	Integer	1 to 199	2
bNeg	Integer	1 to 199	2

Name	Type	Range	Default
se1	Integer	1 to 199	2
se2	Integer	1 to 199	2

**Remarks**

- <bPos>: indicates the physical port connected to the input balanced logical port via the positive line.
- <bNeg>: indicates the physical port connected to the input balanced logical port via the negative line.
- <se1>: indicates the output single-ended port 1.
- <se2>: indicates the output single-ended port 2.

**Return Format**

The query returns the port number that is connected based on the BAL-SE-SE topology, separated by commas.

**Example**

```
:CALCulate1:FSIMulator:BALun:TOPology:BSSended 3,4,1,2 /*Sets the
port number to which the BAL-SE-SE topology maps to 3,4,1,2.*/
:CALCulate1:FSIMulator:BALun:TOPology:BSSended? /*The query returns
3,4,1,2.*/
```

## 7.33.25 :CALCulate<cn>:FSIMulator:BALun:TOPology:SBalanced[:P PORTs]

**Syntax**

```
:CALCulate<cn>:FSIMulator:BALun:TOPology:SBalanced[:PPORTs]
<se>,<bPos>,<bNeg>
```

```
:CALCulate<cn>:FSIMulator:BALun:TOPology:SBalanced[:PPORTs]?
```

**Description**

Sets the port to which the SE-BAL topology is mapped.

Queries the port to which the SE-BAL topology is mapped.

**Parameter**

Name	Type	Range	Default
	Integer	1 to 500	1

Name	Type	Range	Default
se	Integer	1 to 199	2
bPos	Integer	1 to 199	2
bNeg	Integer	1 to 199	2

**Remarks**

- <se>: Single-ended port.
- <bPos>: indicates the physical port connected to the balanced logical port via the positive line.
- <bNeg>: indicates the physical port connected to the balanced logical port via the negative line.

**Return Format**

The query returns the port number that is connected based on the SE-BAL topology, separated by commas.

**Example**

```
:CALCulate1:FSIMulator:BALun:TOPology:SBalanced 1,2,3 /*Sets the
port number to which the SE-BAL topology maps to 1,2,3.*/
:CALCulate1:FSIMulator:BALun:TOPology:SBalanced? /*The query
returns 1,2,3.*/
```

## 7.33.26 :CALCulate<cn>:FSIMulator:BALun:TOPology:SSBalanced[:PPORts]

**Syntax**

```
:CALCulate<cn>:FSIMulator:BALun:TOPology:SSBalanced[:PPORts]
<se1>,<se2>,<bPos>,<bNeg>
```

```
:CALCulate<cn>:FSIMulator:BALun:TOPology:SSBalanced[:PPORts]?
```

**Description**

Sets the port to which the SE-SE-BAL topology is mapped.

Queries the port to which the SE-SE-BAL topology is mapped.

**Parameter**

Name	Type	Range	Default
cn	Integer	1 to 500	1

Name	Type	Range	Default
se1	Integer	1 to 199	2
se2	Integer	1 to 199	2
bPos	Integer	1 to 199	2
bNeg	Integer	1 to 199	2

**Remarks**

- <se1>: indicates the single-ended port 1.
- <se2>: indicates the single-ended port 2.
- <bPos>: indicates the physical port connected to the balanced logical port via the positive line.
- <bNeg>: indicates the physical port connected to the balanced logical port via the negative line.

**Return Format**

The query returns the port number that is connected based on the SE-BAL-BAL topology, separated by commas.

**Example**

```
:CALCulate1:FSIMulator:BALun:TOPology:SSBalanced 1,2,3,4 /*Sets
the port number to which the SE-SE-BAL topology maps to 1,2,3,4.*/
:CALCulate1:FSIMulator:BALun:TOPology:SSBalanced? /*The query
returns 1,2,3,4.*/
```

## 7.33.27 :CALCulate<cn>:FSIMulator:BALun:TOPology:BSSended[:P PORTs]

**Syntax**

```
:CALCulate<cn>:FSIMulator:BALun:TOPology:BSSended[:PPORTs],<bPos>,<b  
Neg>,<se>
```

```
:CALCulate<cn>:FSIMulator:BALun:TOPology:BSSended[:PPORTs]?
```

**Description**

Sets the port to which the BAL-SE topology is mapped.

Queries the port to which the BAL-SE topology is mapped.

**Parameter**

Name	Type	Range	Default
cn	Integer	1 to 500	1
bPos	Integer	1 to 199	-
bNeg	Integer	1 to 199	-
se	Integer	1 to 199	-

**Remarks**

- <p1Pos>: indicates the physical port connected to the balanced logical port 1 via the positive line.
- <p1Neg>: indicates the physical port connected to the balanced logical port 1 via the negative line.
- <se>: Single-ended port.

**Return Format**

The query returns the port number that is connected based on the BAL-SE topology, separated by commas.

**Example**

```
:CALCulate1:FSIMulator:BALun:TOPology:BSSended 1,2,3 /*Sets the
port number to which the BAL-SE topology maps to 1,2,3.*/
:CALCulate1:FSIMulator:BALun:TOPology:BSSended? /*The query returns
1,2,3.*/
```

## 8 :INITiate Commands

### 8.1 :INITiate:CONTinuous

#### Syntax

```
:INITiate:CONTinuous <bool>
:INITiate:CONTinuous?
```

#### Description

Sets the current measurement to Continuous (ON|1) or Single (OFF|0) measurement.

Queries the current measurement state.

#### Parameter

Name	Type	Range	Default
<bool>	Bool	OFF ON 0 1	ON 1

#### Remarks

N/A

#### Return Format

The query returns 1 or 0.

#### Example

```
:INITiate:CONTinuous OFF /*Sets the measurement status to Single.*/
:INITiate:CONTinuous? /*The query returns 0.*/
```

## 9 :LAN Commands

The :LAN commands are used to set and query the LAN parameters.

### 9.1 :LAN:DHCP

#### Syntax

```
:LAN:DHCP <bool>
```

```
:LAN:DHCP?
```

#### Description

Turns on or off the DHCP configuration mode; or queries the on/off status of the current DHCP configuration mode.

#### Parameter

Name	Type	Range	Default
<bool>	Bool	{{1 ON}} {{0 OFF}}	1 ON

#### Remarks

- When the three IP configuration types (DHCP, Auto IP, and Static IP) are all turned on, the priority of the parameter configuration from high to low is "DHCP", "Auto IP", and "Static IP". The three IP configuration types cannot be all turned off at the same time.
- When DHCP is valid, the DHCP server in the current network will assign the network parameters (such as the IP address) for the instrument.
- After the `:LAN:APPLY` command is executed, the configuration type can take effect immediately.

#### Return Format

The query returns 1 or 0.

#### Example

```
:LAN:DHCP OFF /*Disables DHCP configuration mode.*/
:LAN:DHCP? /*The query returns 0.*/
```

## 9.2 :LAN:AUTOip

### Syntax

```
:LAN:AUTOip <bool>
```

```
:LAN:AUTOip?
```

### Description

Turns on or off the Auto IP configuration mode; or queries the on/off status of the current Auto IP configuration mode.

### Parameter

Name	Type	Range	Default
<bool>	Bool	{{1 ON}}{0 OFF}}	1 ON

### Remarks

When the auto IP mode is valid, disable DHCP manually. In auto IP mode, the instrument will get the IP address (ranging from 169.254.0.1 to 169.254.255.254) and the subnet mask (255.255.0.0) automatically according to the current network configuration.

### Return Format

The query returns 1 or 0.

### Example

```
:LAN:AUTOip OFF          /*Disables the Auto IP configuration
mode.*/
:LAN:AUTOip?             /*The query returns 0.*/
```

## 9.3 :LAN:MANual

### Syntax

```
:LAN:MANual <bool>
```

```
:LAN:MANual?
```

### Description

Turns on or off the static IP configuration mode; or queries the on/off status of the static IP configuration mode.

### Parameter

Name	Type	Range	Default
<bool>	Bool	{{1 ON}}{0 OFF}}	0 OFF

**Remarks**

When the static IP mode is valid, disable DHCP and Auto IP manually. You can self-define the network parameters of the instrument, such as IP address, subnet mask, gateway, and DNS address. For the setting of the IP address, refer to the `:LAN:IPADdress` command. For the setting of the subnet mask, refer to the `:LAN:SMASk` command. For the setting of the gateway, refer to the `:LAN:GATeway` command. For the setting of DNS, refer to the `:LAN:DNS` command.

**Return Format**

The query returns 1 or 0.

**Example**

```
:LAN:MANual ON      /*Enables the static IP configuration mode.*/
:LAN:MANual?       /*The query returns 1.*/
```

## 9.4 :LAN:IPADdress

**Syntax**

`:LAN:IPADdress <string>`

`:LAN:IPADdress?`

**Description**

Sets or queries the IP address of the instrument.

**Parameter**

Name	Type	Range	Default
<string>	ASCII String	Refer to <i>Remarks</i>	-

**Remarks**

- The format of <string> is nnn.nnn.nnn.nnn. The range of the first section of "nnn" is from 0 to 223 (except 127), and the ranges of the other three sections of "nnn" are from 0 to 255.
- Only when the IP configuration mode is set to Static IP mode, and both DHCP and Auto IP are disabled, can you use the set IP address.

**Return Format**

The query returns the current IP address in strings.

**Example**

```
:LAN:IPAdDress 192.168.1.10 /*Sets the IP address to
192.168.1.10.*/*
:LAN:IPAdDress? /*The query returns 192.168.1.10.*/*
```

## 9.5 :LAN:SMASK

**Syntax**

```
:LAN:SMASK <string>
```

```
:LAN:SMASK?
```

**Description**

Sets or queries the subnet mask.

**Parameter**

Name	Type	Range	Default
<string>	ASCII String	Refer to <i>Remarks</i>	-

**Remarks**

- The format of <string> is nnn.nnn.nnn.nnn. The range of the section "nnn" is from 0 to 255.
- Only when the IP configuration mode is set to Static IP mode, and both DHCP and Auto IP are disabled, can you use the set subnet mask.

**Return Format**

The query returns the current subnet mask in strings.

**Example**

```
:LAN:SMASK 255.255.255.0 /*Sets the subnet mask to
255.255.255.0.*/*
:LAN:SMASK? /*The query returns 255.255.255.0.*/*
```

## 9.6 :LAN:DSERver?

**Syntax**

```
:LAN:DSERver?
```

**Description**

Queries the address of the DHCP server.

**Parameter**

N/A

**Remarks**

N/A

**Return Format**

The query returns the address of the DHCP server in strings.

**Example**

N/A

## 9.7 :LAN:GATeway

**Syntax**

```
:LAN:GATeway <string>
```

```
:LAN:GATeway?
```

**Description**

Sets or queries the default gateway.

**Parameter**

Name	Type	Range	Default
<string>	ASCII String	Refer to <i>Remarks</i>	-

**Remarks**

- The format of <string> is nnn.nnn.nnn.nnn. The range of the first section of "nnn" is from 0 to 223 (except 127), and the ranges of the other three sections of "nnn" are from 0 to 255.
- Only when the IP configuration mode is set to Static IP mode, and both DHCP and Auto IP are disabled, can you use the set default gateway.

**Return Format**

The query returns the current gateway in strings.

**Example**

```
:LAN:GATeway 192.168.1.1 /*Sets the default gateway to
192.168.1.1.*/*
:LAN:GATeway? /*The query returns 192.168.1.1.*/*
```

## 9.8 :LAN:DNS

### Syntax

```
:LAN:DNS <string>
```

```
:LAN:DNS?
```

### Description

Sets or queries the DNS address.

### Parameter

Name	Type	Range	Default
<string>	ASCII String	Refer to <i>Remarks</i>	-

### Remarks

- The format of <string> is nnn.nnn.nnn.nnn. The range of the first section of "nnn" is from 0 to 223 (except 127), and the ranges of the other three sections of "nnn" are from 0 to 255.
- Only when the IP configuration mode is set to Static IP mode, and both DHCP and Auto IP are disabled, can you use the set DNS address.

### Return Format

The query returns the current DNS address in strings.

### Example

```
:LAN:DNS 192.168.1.1 /*Sets the DNS address to
192.168.1.1.*/
:LAN:DNS? /*The query returns 192.168.1.1.*/
```

## 9.9 :LAN:MAC?

### Syntax

```
:LAN:MAC?
```

### Description

Queries the MAC address of the instrument.

### Parameter

N/A

**Remarks**

N/A

**Return Format**

The query returns the MAC address in strings. For example, 00:19:AF:00:11:22.

**Example**

N/A

## 9.10 :LAN:STATus?

**Syntax**

```
:LAN:STATus?
```

**Description**

Queries the current network configuration status.

**Parameter**

N/A

**Remarks**

- **UNLINK:** not connected.
- **CONNECTED:** the network is successfully connected.
- **INIT:** the instrument is acquiring an IP address.
- **IPCONFLICT:** there is an IP address conflict.
- **BUSY:** please wait...
- **CONFIGURED:** the network configuration has been successfully configured.
- **DHCPFAILED:** the DHCP configuration has failed.
- **INVALIDIP:** invalid IP.
- **IPLOSE:** IP lost.

**Return Format**

The query returns UNLINK, CONNECTED, INIT, IPCONFLICT, BUSY, CONFIGURED, DHCPFAILED, INVALIDIP, or IPLOSE.

**Example**

N/A

## 9.11 :LAN:VISA?

### Syntax

:LAN:VISA? <type>

### Description

Queries the VISA address of the instrument.

### Parameter

Name	Type	Range	Default
<type>	Discrete	{USB LXI}	-

### Remarks

This command contains a parameter "type" and it is used to set or query the address type. By default, it returns the LXI address.

### Return Format

The query returns the VISA address in strings.

### Example

N/A

## 9.12 :LAN:MDNS

### Syntax

:LAN:MDNS <bool>

:LAN:MDNS?

### Description

Enables or disables mDNS; or queries the mDNS status.

### Parameter

Name	Type	Range	Default
<bool>	Bool	{{1 ON}}{0 OFF}}	0 OFF

### Remarks

N/A

### Return Format

The query returns 1 or 0.

**Example**

```
:LAN:MDNS ON /*Enables mDNS.*/
:LAN:MDNS? /*The query returns 1.*/
```

**9.13 :LAN:APPLY****Syntax**

```
:LAN:APPLY
```

**Description**

Applies the network configuration.

**Parameter**

N/A

**Remarks**

After configuring all the LAN-related parameters with the :LAN commands, you need to send this command to make all the LAN configurations take effect.

**Return Format**

N/A

**Example**

```
N/A
```

**9.14 :LAN:HOST:NAME****Syntax**

```
:LAN:HOST:NAME <name>
```

```
:LAN:HOST:NAME?
```

**Description**

Sets or queries the host name.

**Parameter**

Name	Type	Range	Default
<name>	ASCII String	The label can contain English letters and numbers, as well as some symbols.	-

**Remarks**

N/A

**Return Format**

The query returns the host name in ASCII strings.

**Example**

N/A

## 9.15 :LAN:DESCRiption

**Syntax**

:LAN:DESCRiption <name>

:LAN:DESCRiption?

**Description**

Sets or queries the description.

**Parameter**

Name	Type	Range	Default
<name>	ASCII String	The label can contain English letters and numbers, as well as some symbols.	-

**Remarks**

N/A

**Return Format**

The query returns the description in ASCII strings.

**Example**

N/A

## 10 :MMEMory Commands

### 10.1 :MMEMory:STORe:LIMit

#### Syntax

```
:MMEMory:STORe:LIMit <file_name>
```

#### Description

Saves the limit test table as a file with the specified filename suffixed with "\*.csv" to the default path.

#### Parameter

Name	Type	Range	Default
<file_name>	ASCII String	Name of the file to be saved	-

#### Remarks

- To set and query the default path, run the *:MMEMory:CDIRectory* command.
- If the specified file already exists, overwrite it.

#### Return Format

N/A

#### Example

```
:MMEMory:STORe:LIMit mydata.csv /*Saves the limit test table as a file with the filename "mydata.csv" to the default path.*/
```

### 10.2 :MMEMory:STORe:CORRection

#### Syntax

```
:MMEMory:STORe:CORRection <file_name>
```

#### Description

Saves the calibration sets file with the specified filename suffixed with "\*.cal" to the default path.

**Parameter**

Name	Type	Range	Default
<file_name>	ASCII String	Name of the file to be saved	-

**Remarks**

- To set and query the default path, run the `:MMEMory:CDIRectory` command.
- If the specified file already exists, overwrite it.

**Return Format**

N/A

**Example**

```
:MMEMory:STORe:CORRection mydata.cal /*Saves the calibration sets
file with the filename "mydata.cal" to the default path.*/
```

## 10.3 :MMEMory:STORe:STATe

**Syntax**

```
:MMEMory:STORe:STATe <file_name>
```

**Description**

Saves the current instrument state as a file with the specified filename suffixed with ".sta" to the default path.

**Parameter**

Name	Type	Range	Default
<file_name>	ASCII String	Name of the file to be saved	-

**Remarks**

- To set and query the default path, run the `:MMEMory:CDIRectory` command.
- If the specified file already exists, overwrite it.

**Return Format**

N/A

**Example**

```
:MMEMory:STORe:STATe mydata.sta /*Saves the current instrument
state as a file with the filename "mydata.sta" to the default
path.*/
```

## 10.4 :MMEMory:STORe:CSARchive

### Syntax

```
:MMEMory:STORe:CSARchive <file_name>
```

### Description

Saves the current instrument state and calibration sets as a file with the specified filename suffixed with ".csa" to the default path.

### Parameter

Name	Type	Range	Default
<file_name>	ASCII String	Name of the file to be saved	-

### Remarks

- To set and query the default path, run the *:MMEMory:CDIRectory* command.
- If the specified file already exists, overwrite it.

### Return Format

N/A

### Example

```
:MMEMory:STORe:CSARchive mydata.csa /*Saves the state and
calibration sets as a file with the filename "mydata.csa" to the
default path.*/
```

## 10.5 :MMEMory:STORe:DATA

### Syntax

```
:MMEMory:STORe:DATA <file_name>,<type>,<scope>,<format>,<selector>
```

### Description

Saves the specified trace data with the specified filename to the default path.

### Parameter

Name	Type	Range	Default
<file_name>	ASCII String	Refer to Remarks	-
<type>	ASCII String	Refer to Remarks	-
<scope>	ASCII String	Refer to Remarks	-

Name	Type	Range	Default
<format>	ASCII String	Refer to Remarks	-
<selector>	Integer	Refer to Remarks	-

### Remarks

- <file\_name>: indicates the filename to be saved and its extension name. If the extension name does not match the file type, the query will not return errors, but the data returned may not be your expected data.
- <type>: indicates the file type to be saved. It is suffixed with \*.csv.
- <scope>: indicates the measurement data to be saved.
  - Trace: saves the data of the specified measurement trace only.
  - Displayed: saves all the displayed measurement trace data.
  - Channel: saves all the measurement trace data in the channel for the specified measurement.
  - Auto: When correction is disabled, it saves the current measurement trace. When correction is enabled, it saves all the correction parameters associated with the calibration ports in the calibration sets. To query the on/off status of correction, run the *:DISPlay:WINDow:NEW* command.
- <format>: indicates four data formats to be saved.
  - Displayed: the format is the same as what is displayed on the VNA screen.
  - RI: Real/Imaginary.
  - MA: LinMag/Angle
  - DB: LogMag/Angle
- <selector>:
  - -1: use when <scope> = "Displayed".
  - Measurement number: use for all other <scope> selections.

To set and query the default path, run the *:MMEMory:CDIRectory* command. If the specified file already exists, overwrite it.

**Return Format**

N/A

**Example**

```
:MMEMory:STORe:DATA mydata,CSV,Trace,Displayed,1 /*Saves the
Trace1 data as a file named "mydata.csv" to the default path.*/
```

## 10.6 :MMEMory:STORe:DATA:SNP

**Syntax**

```
:MMEMory:STORe:DATA:SNP <file_name>,<ports>,<format>,<touchstoneversion>
```

**Description**

Saves the specified measurement trace data as a file with the specified filename suffixed with "\*.snp" to the default path.

**Parameter**

Name	Type	Range	Default
<file_name>	ASCII String	Refer to Remarks	-
<ports>	ASCII String	Refer to Remarks	-
<format>	Discrete	{RI DB MA AUTO}	-
<touchstoneversion>	Real	Refer to Remarks	-

**Remarks**

- <file\_name>: indicates the filename to be saved. The suffix of the file must be "\*.snp". n indicates the number of ports.
- <ports>: indicates the port number. The port number is separated by vertical bar (|).
- <format>: indicates four data formats to be saved.
  - RI: Real/Imaginary.
  - DB: Log Mag/Angle
  - MA: LinMag/Angle
  - AUTO: Auto. Data is saved in currently selected trace format  
(:CALCulate<cn>:MEASure<mn>:FORMat).

- <touchstoneversion> indicates version number of Touchstone. Currently, only 1.1 is supported.

To set and query the default path, run the `:MMEMory:CDIRectory` command. If the specified file already exists, overwrite it.

#### Return Format

N/A

#### Example

```
:MMEMory:STORe:DATA:SNP mydata.s2p,1|2,RI,1.1 /*Saves the
measurement data of Port 1 and Port 2 as a file named "mydata.s2p"
to the default path.*/
```

## 10.7 :MMEMory:LOAD:LIMit

### Syntax

```
:MMEMory:LOAD:LIMit <file_name>
```

### Description

Loads the specified limit test table file suffixed with "\*.csv" from the default path.

### Parameter

Name	Type	Range	Default
<file_name>	ASCII String	Name of the file to be loaded	-

### Remarks

- To set and query the default path, run the `:MMEMory:CDIRectory` command.
- This command is only valid when the specified file exists under the default path.

### Return Format

N/A

### Example

```
:MMEMory:LOAD:LIMit mydata.csv /*Loads mydata.csv file from the
default path.*/
```

## 10.8 :MMEMory:LOAD:CORRection

### Syntax

```
:MMEMory:LOAD:CORRection <file_name>
```

**Description**

Loads the specified calibration sets file suffixed with "\*.cal" from the default path.

**Parameter**

Name	Type	Range	Default
<file_name>	ASCII String	Name of the file to be loaded	-

**Remarks**

- To set and query the default path, run the *:MMEMory:CDIRectory* command.
- This command is only valid when the specified file exists under the default path.

**Return Format**

N/A

**Example**

```
:MMEMory:LOAD:CORRection mydata.cal /*Loads the mydata.cal file
from the default path.*/
```

## 10.9 :MMEMory:LOAD:STATE

**Syntax**

```
:MMEMory:LOAD:STATE <file_name>
```

**Description**

Loads the specified state file suffixed with "\*.sta" from the default path.

**Parameter**

Name	Type	Range	Default
<file_name>	ASCII String	Name of the file to be loaded	-

**Remarks**

- To set and query the default path, run the *:MMEMory:CDIRectory* command.
- This command is only valid when the specified file exists under the default path.

**Return Format**

N/A

**Example**

```
:MMEMory:LOAD:STATE mydata.sta /*Loads the mydata.sta file from
the default path.*/
```

## 10.10 :MMEMory:LOAD:CSARchive

**Syntax**

```
:MMEMory:LOAD:CSARchive <file_name>
```

**Description**

Loads the specified state file and calibration sets file suffixed with "\*.csa" from the default path.

**Parameter**

Name	Type	Range	Default
<file_name>	ASCII String	Name of the file to be loaded	-

**Remarks**

- To set and query the default path, run the *:MMEMory:CDIRectory* command.
- This command is only valid when the specified file exists under the default path.

**Return Format**

N/A

**Example**

```
:MMEMory:LOAD:CSARchive mydata.csa /*Loads the mydata.csa file from
the default path.*/
```

## 10.11 :MMEMory:LOAD:DATA:SNP

**Syntax**

```
:MMEMory:LOAD:DATA:SNP <file_name>
```

**Description**

Loads the specified SNP file suffixed with "\*.snp" from the default path.

**Parameter**

Name	Type	Range	Default
<file_name>	ASCII String	Name of the file to be loaded	-

**Remarks**

- To set and query the default path, run the `:MMEMory:CDIRectory` command.
- This command is only valid when the specified file exists under the default path.

**Return Format**

N/A

**Example**

```
:MMEMory:LOAD:DATA:SNP mydata.snp /*Loads the mydata.snp file from
the default path.*/
```

## 10.12 :MMEMory:CATalog:CORRection?

**Syntax**

```
:MMEMory:CATalog:CORRection? <path>
```

**Description**

Queries calibration file list under the specified path.

**Parameter**

Name	Type	Range	Default
<path>	ASCII String	Path	-

**Remarks**

To set and query the default path, run the `:MMEMory:CDIRectory` command.

**Return Format**

The query returns a list of calibration files in strings, separated by commas.

**Example**

```
:MMEMory:CATalog:CORRection? C:/data/UserData/tmp /*The query
returns 2open.cal,2open2.cal,power.cal,NewFile1.cal.*/
```

## 10.13 :MMEMory:CATalog:STATe?

**Syntax**

```
:MMEMory:CATalog:STATe? <path>
```

**Description**

Queries the list of instrument state files under the specified path.

**Parameter**

Name	Type	Range	Default
<path>	ASCII String	Name of the file to be saved	-

**Remarks**

To set and query the default path, run the *:MMEMory:CDIRectory* command.

**Return Format**

The query returns a list of instrument state files in strings, separated by commas.

**Example**

```
:MMEMory:CATalog:STATe? /data/UserData/ /*The query returns
maxfree.sta,seg1.sta.*/*
```

## 10.14 :MMEMory:CATalog:CSARchive?

**Syntax**

```
:MMEMory:CATalog:CSARchive? <path>
```

**Description**

Queries the list of instrument state files and calibration files under the specified path.

**Parameter**

Name	Type	Range	Default
<path>	ASCII String	Path	-

**Remarks**

To set and query the default path, run the *:MMEMory:CDIRectory* command.

**Return Format**

The query returns the list of instrument state files and calibration files in strings, separated by commas.

**Example**

```
:MMEMory:CATalog:CSARchive? /data/UserData/ /*The query returns
bbb.csa,stablity.csa,test5ch.csa.*/*
```

## 10.15 :MMEMory:CATalog:CSTate?

### Syntax

```
:MMEMory:CATalog:CSTate? <path>
```

### Description

Queries the list of instrument state files and link to calibration data files (\*.cst) under the specified path.

### Parameter

Name	Type	Range	Default
<path>	ASCII String	Path	-

### Remarks

To set and query the default path, run the *:MMEMory:CDIRectory* command.

### Return Format

The query returns a list of instrument state files and link to calibration data files (\*.cst) in strings, separated by commas.

### Example

```
:MMEMory:CATalog:CSTate? /data/UserData/ /*The query returns NO
CATALOG.* /
```

## 10.16 :MMEMory:CATalog[:File]?

### Syntax

```
:MMEMory:CATalog[:File]? <path>
```

### Description

Queries all the files under the specified path.

### Parameter

Name	Type	Range	Default
<path>	ASCII String	Path	-

### Remarks

To set and query the default path, run the *:MMEMory:CDIRectory* command.

**Return Format**

The query returns a list of files in strings, separated by commas.

**Example**

```
:MMEMory:CATalog? /data/UserData/ /*The query returns
RigolVNA6.png,RigolVNA7.png.*/
```

## 10.17 :MMEMory:CATalog<char>? <folder>

**Syntax**

```
:MMEMory:CATalog<char>? <folder>
```

**Description**

Queries the file types under the specified path.

**Parameter**

Name	Type	Range	Default
<char>	ASCII String	Refer to Remarks	[:File]
<folder>	ASCII String	Refer to Remarks	-

**Remarks**

<char> indicates the file type. The available file types include:

- [:File]: no file type is specified. All the file types will be listed.
- :STATE: indicates the state file suffixed with "\*.sta".
- :CORRection: indicates the calibration sets file suffixed with "\*.cal".
- CSArchive: indicates the state file and calibration sets suffixed with "\*.csa".

<folder> indicates the query path.

**Return Format**

- If the queried path does not exist, the query returns Not applicable.
- If no specified type of the file exists, the query returns NO CATALOG.
- If it is not the above case, the query returns the filename list in strings, separated by commas.

**Example**

```
:MMEMory:CATalog:CORRection? /data/UserData/ /*The query returns
2open.cal,2open2.cal,power.cal.*/
```

**10.18 :MMEMory:DISK:FORMat****Syntax**

```
:MMEMory:DISK:FORMat
```

**Description**

Clears the disk safely.

**Parameter**

N/A

**Remarks**

This command will clear the internal memory. Please perform data backup before running this command.

**Return Format**

N/A

**Example**

```
N/A
```

**10.19 :MMEMory:MDIRectory****Syntax**

```
:MMEMory:MDIRectory <file_name>
```

**Description**

Create a specified directory.

**Parameter**

Name	Type	Range	Default
<file_name>	ASCII String	Refer to Remarks	-

**Remarks**

<file\_name> is the complete directory path.

**Return Format**

N/A

**Example**

```
:MMEMory:MDIRectory C:/data/UserData/tmp /*Creates a directory
path C:/data/UserData/tmp.*/*
```

**10.20 :MMEMory:CDIRectory****Syntax**

```
:MMEMory:CDIRectory <file_name>
```

```
:MMEMory:CDIRectory?
```

**Description**

Switches to the default path.

Queries the default path.

**Parameter**

Name	Type	Range	Default
<file_name>	ASCII String	Refer to Remarks	/data/UserData/

**Remarks**

The <file\_name> parameter should contain the existing file path and the folder name.

**Return Format**

The query returns the default path in strings.

**Example**

```
:MMEMory:CDIRectory /data/UserData/logs /*Sets the default path to /
data/UserData/logs.*/*
:MMEMory:CDIRectory? /*The query returns /data/UserData/logs.*/*
```

# 11 :SYSTem Commands

## 11.1 :SYSTem:CHANnels:DELeTe

### Syntax

```
:SYSTem:CHANnels:DELeTe <cn>
```

### Description

Deletes the specified channel.

### Parameter

Name	Type	Range	Default
<cn>	Integer	1 to 500	1

### Remarks

N/A

### Return Format

N/A

### Example

```
:SYSTem:CHANnels:DELeTe 1 /*Deletes Channel 1.*/
```

## 11.2 :SYSTem:BEEPer

### Syntax

```
:SYSTem:BEEPer <bool>
```

```
:SYSTem:BEEPer?
```

### Description

Turns on or off the beeper or queries the on/off status of the beeper.

### Parameter

Name	Type	Range	Default
<bool>	Bool	{{1 ON}} {{0 OFF}}	0 OFF

### Remarks

N/A

**Return Format**

The query returns 1 or 0.

**Example**

```
:SYSTem:BEEPer ON /*Enables the beeper.*/
:SYSTem:BEEPer? /*The query returns 1.*/
```

## 11.3 :SYSTem:DATE

**Syntax**

```
:SYSTem:DATE <year>,<month>,<day>
```

```
:SYSTem:DATE?
```

**Description**

Sets or queries the system date.

**Parameter**

Name	Type	Range	Default
<year>	Integer	1900 to 2100	-
<month>	Integer	1 to 12	-
<day>	Integer	1 to 31 (28, 29, or 30)	-

**Remarks**

N/A

**Return Format**

The query returns the system date in strings. They are separated by hyphens.

**Example**

```
:SYSTem:DATE 2017,10,17 /*Sets the system data to 2017-10-17.*/
:SYSTem:DATE? /*The query returns 2017-10-17.*/
```

## 11.4 :SYSTem:TIME

**Syntax**

```
:SYSTem:TIME <hours>,<minutes>,<seconds>
```

```
:SYSTem:TIME?
```

**Description**

Sets or queries the system time.

**Parameter**

Name	Type	Range	Default
<hours>	Integer	0 to 23	-
<minutes>	Integer	0 to 59	-
<seconds>	Integer	0 to 59	-

**Remarks**

There is a certain delay between the return time value and the set time value due to the command response time and other factors.

**Return Format**

The query returns the system time in strings.

**Example**

```
:SYSTem:TIME 16,10,17 /*Sets the system time to 16:10:17.*/
:SYSTem:TIME? /*The query returns 16:10:17.*/
```

## 11.5 :SYSTem:STIME

**Syntax**

```
:SYSTem:STIME <bool>
```

```
:SYSTem:STIME?
```

**Description**

Sets or queries whether to display the system time.

**Parameter**

Name	Type	Range	Default
<bool>	Bool	{{1 ON}} {{0 OFF}}	1 ON

**Remarks**

N/A

**Return Format**

The query returns 0 or 1.

**Example**

```
:SYSTem:STIME ON /*Sets to display the system time.*/
:SYSTem:STIME? /*The query returns 1.*/
```

## 11.6 :SYSTem:LANGuage

### Syntax

```
:SYSTem:LANGuage <language>
```

```
:SYSTem:LANGuage?
```

### Description

Sets or queries the system language.

### Parameter

Name	Type	Range	Default
<language>	Discrete	{SCHinese TCHinese KORean JAPanese ENGLish GERMan PORTuguese POLish FRENch RUSSian SPAN THAI INDonesian}	SCHinese

### Remarks

The language settings are not affected by factory default settings (send the *\*RST* command).

### Return Format

The query returns SCH, TCH, KOR, JAP, ENGL, GERM, PORT, POL, FREN, RUSS, SPAN, THAI, or IND.

### Example

```
:SYSTem:LANGuage ENGLish /*Sets the system language to ENGLISH.*/
:SYSTem:LANGuage? /*The query returns ENGL.*/
```

## 11.7 :SYSTem:PSTatus

### Syntax

```
:SYSTem:PSTatus <sat>
```

```
:SYSTem:PSTatus?
```

### Description

Sets or queries the power status of the instrument.

### Parameter

Name	Type	Range	Default
<sat>	Discrete	{DEFault OPEN}	OPEN

**Remarks**

- **DEFault:** after the instrument is powered on, you need to press the Power key on the front panel to start the instrument.
- **OPEN:** after the instrument is powered on, it starts directly. You do not have to press the Power key.

**Return Format**

The query returns DEF or OPEN.

**Example**

```
:SYSTem:PSTatus DEFault /*Sets the power status to DEFault.*/  
:SYSTem:PSTatus? /*The query returns DEF.*/
```

## 11.8 :SYSTem:RESet

**Syntax**

```
:SYSTem:RESet
```

**Description**

Resets the system to power on.

**Parameter**

N/A

**Remarks**

N/A

**Return Format**

N/A

**Example**

```
N/A
```

## 11.9 :SYSTem:PWRD

**Syntax**

```
:SYSTem:PWRD
```

**Description**

Disconnects the instrument from power.

**Parameter**

N/A

**Remarks**

N/A

**Return Format**

N/A

**Example**

N/A

## 11.10 :SYSTem:VERSion?

**Syntax**`:SYSTem:VERSion?`**Description**

Queries the version number of the SCPI used by the system.

**Parameter**

N/A

**Remarks**

N/A

**Return Format**

The query returns the SCPI version number in strings.

**Example**`:SYSTem:VERSion? /*The query returns 3.0 */`

## 11.11 :SYSTem:LOCKed

**Syntax**`:SYSTem:LOCKed <bool>``:SYSTem:LOCKed?`**Description**

Enables or disables the front-panel key operation and touch screen operation; queries whether the front-panel key operation and touch screen operation are locked.

**Parameter**

Name	Type	Range	Default
<bool>	Bool	{{1 ON}} {{0 OFF}}	0 OFF

**Remarks**

N/A

**Return Format**

The query returns 1 or 0.

**Example**

```
:SYSTem:LOCKed ON          /*Disables the front-panel key operation
and touch screen operation.*/
:SYSTem:LOCKed?           /*The query returns 1.*/
```

## 11.12 :SYSTem:GPIB

**Syntax**

```
:SYSTem:GPIB <adr>
```

```
:SYSTem:GPIB?
```

**Description**

Sets or queries the GPIB address.

**Parameter**

Name	Type	Range	Default
<adr>	Integer	1 to 30	1

**Remarks**

N/A

**Return Format**

The query returns an integer ranging from 1 to 30.

**Example**

```
:SYSTem:GPIB 2            /*Sets the GPIB address to 2.*/
:SYSTem:GPIB?            /*The query returns 2.*/
```

## 11.13 :SYSTem:OPTion:INSTall

**Syntax**

```
:SYSTem:OPTion:INSTall <license>
```

**Description**

Installs an option.

**Parameter**

Name	Type	Range	Default
<license>	ASCII String	Refer to Remarks	-

**Remarks**

- To install the option, first purchase the required option to obtain the key, and then use the key to obtain the option license according to the following steps.
  - Log in to the RIGOL official website (<http://www.rigol.com>). Click **SERVICE CENTER > LICENSE ACTIVATION** to enter the license activation interface.
  - In the interface, input the correct key, serial number, and the verification code. Click **Generate** to obtain the download link of the option license file. If you need to use the option license file, click to download the file to the specified directory of the USB storage device.
- The <license> format is "<series>-<opt>@<code>".
  - **<series>**: DNA6000-R
  - **<opt>**: indicates the option name. The options supported include:
    - BND: Bundle option, function and application bundle option, including TDA, TDR, and DTF.
    - TDA: time-domain analysis option.
    - TDR: time-domain reflection analysis (unavailable temporarily)
    - DTF: distance to fault option.
  - **<code>**: The license is a fixed length of strings. Each instrument has a unique license.
- To query whether the option has been successfully installed, refer to *:SYSTem:OPTion:STATus?*

**Return Format**

N/A

**Example**

```
:SYSTem:OPTion:INSTall DNA6000-R-
TDA@A7DEC6C1E10D42EE8E3AF0728C3D272F507E646EB54B9C97E6CCBA98468A46A8
63FED814C24D47B8B40C894B1822660B94852E6778392281A20B54B4E723E3FD
```

**11.14 :SYSTem:OPTion:UNINStall****Syntax**

```
:SYSTem:OPTion:UNINStall
```

**Description**

Uninstalls all the official options.

**Parameter**

N/A

**Remarks**

After the option has been uninstalled, you need to restart the instrument.

**Return Format**

N/A

**Example**

N/A

**11.15 :SYSTem:OPTion:STATus?****Syntax**

```
:SYSTem:OPTion:STATus? <type>
```

**Description**

Queries whether an option is activated or not.

**Parameter**

Name	Type	Range	Default
<type>	Discrete	{BND TDA TDR DTF}	-

**Remarks**

- BND: Bundle option, function and application bundle option, including TDA, TDR, and DTF.
- TDA: time-domain analysis option.

- TDR: time-domain reflection analysis (unavailable temporarily)
- DTF: distance to fault option.

### Return Format

The query returns 0 or 1.

- 0: indicates that the option is not installed.
- 1: indicates that the official option has been installed.

### Example

```
:SYSTem:OPTion:STATus? DTF /*The query returns 1.*/
```

## 11.16 :SYSTem:OPTion:VALid?

### Syntax

```
:SYSTem:OPTion:VALid? <type>
```

### Description

Queries whether an option is activated or not.

This command exists for backwards compatibility. Use the command *:SYSTem:OPTion:STATus?*.

### Parameter

Name	Type	Range	Default
<type>	Discrete	{BND TDA TDR DTF}	-

### Remarks

- BND: Bundle option, function and application bundle option, including TDA, TDR, and DTF.
- TDA: time-domain analysis option.
- TDR: time-domain reflection analysis (unavailable temporarily)
- DTF: distance to fault option.

### Return Format

The query returns 0 or 1.

- 0: indicates that the option is not installed.

- 1: indicates that the official option has been installed.

**Example**

```
:SYSTem:OPTion:STATus? DTF /*The query returns 1.*/
```

## 11.17 :SYSTem:PRESet

**Syntax**

```
:SYSTem:PRESet
```

**Description**

Restores the instrument to the preset state.

**Parameter**

N/A

**Remarks**

This command has the same function as clicking **Preset**, namely recalling the default values or user-preset values related to this key.

**Return Format**

N/A

**Example**

```
N/A
```

## 11.18 :SYSTem:ERRor?

**Syntax**

```
:SYSTem:ERRor?
```

**Description**

Queries the system error.

**Return Format**

The query returns the system errors in strings.

## 11.19 :SYSTem:MACRo:COpy:CHANnel<cn>[:TO]

**Syntax**

```
:SYSTem:MACRo:COpy:CHANnel<cn>[:TO] <tcn>
```

**Description**

Copies the specified channel.

**Parameter**

Name	Type	Range	Default
<cn>	Integer	1 to 500	1
<tcn>	Integer	1 to 500	-

**Remarks**

<cn> is the original channel ID and <tcn> is the target channel ID. Running this command will copy all configuration parameters of the channel <cn> to the target channel <tcn>.

**Return Format**

N/A

**Example**

```
:SYSTem:MACRo:COpy:CHANnel1 2 /*Copies configuration parameters of  
CH1 to CH2.*/
```

## 12 :TRIGger Commands

The :TRIGger commands are used to set and query trigger related parameters.

### 12.1 :TRIGger:DElay

#### Syntax

```
:TRIGger:DElay <time>
```

```
:TRIGger:DElay?
```

#### Description

Sets the global trigger delay.

Queries the global trigger delay.

#### Parameter

Name	Type	Range	Default
<time>	Real	0 s to 3 s	0 s

#### Remarks

This command is only valid when the trigger source is set to internal trigger.

#### Return Format

The query returns the global trigger delay in scientific notation.

#### Example

```
:TRIGger:DElay 2 /*Enables the global trigger delay to 2 s.*/
:TRIGger:DElay? /*The query returns +2.00E+00.*/
```

### 12.2 :TRIGger[:SEquence]:SOURce

#### Syntax

```
:TRIGger[:SEquence]:SOURce <type>
```

```
:TRIGger[:SEquence]:SOURce?
```

#### Description

Sets the trigger source.

Queries the trigger source.

**Parameter**

Name	Type	Range	Default
<type>	Discrete	{EXternal IMMEDIATE MANual}	IMMEDIATE

**Remarks**

- **EXternal:** external trigger. It receives the external signals via the rear-panel TRIG IN connector.
- **IMMEDIATE:** internal trigger source. When you select internal trigger source, the continuous trigger signals are generated by the analyzer.
- **MANual:** When you select "Manual" trigger source, press the Trigger key on the front panel or run the `:INITiate<cn>[:IMMEDIATE]` command to generate a trigger signal.

**Return Format**

The query returns EXT, IMM, or MAN.

**Example**

```
:TRIGger:SOURce MANual /*Sets the trigger source to MANual.*/
:TRIGger:SOURce? /*The query returns MAN.*/
```

## 12.3 :TRIGger[:SEQuence]:SCOPE

**Syntax**

```
:TRIGger[:SEQuence]:SCOPE <enum>
```

```
:TRIGger[:SEQuence]:SCOPE?
```

**Description**

Sets the trigger scope.

Queries the trigger scope.

**Parameter**

Name	Type	Range	Default
<enum>	Discrete	{ALL CURRent}	CURRent

**Remarks**

N/A

**Return Format**

The query returns ALL or CURR.

**Example**

```
:TRIGger:SCOPE ALL /*Sets the trigger scope to ALL.*/
:TRIGger:SCOPE? /*The query returns ALL.*/
```

## 12.4 :TRIGger[:SEQuence]:TYPE

**Syntax**

```
:TRIGger[:SEQuence]:TYPE <enum>
```

```
:TRIGger[:SEQuence]:TYPE?
```

**Description**

Sets the trigger condition.

Queries the trigger condition.

**Parameter**

Name	Type	Range	Default
<enum>	Discrete	{EDGE LEVeL}	LEVeL

**Remarks**

EDGE indicates triggering on the specified edge. LEVeL indicates triggering on the specified level.

**Return Format**

The query returns EDGE or LEV.

**Example**

```
:TRIGger:TYPE EDGE /*Sets the trigger condition to EDGE.*/
:TRIGger:TYPE? /*The query returns EDGE.*/
```

## 12.5 :TRIGger[:SEQuence]:SLOPe

**Syntax**

```
:TRIGger[:SEQuence]:SLOPe <enum>
```

```
:TRIGger[:SEQuence]:SLOPe?
```

**Description**

Sets the polarity expected by the external trigger input circuitry.

Queries the polarity expected by the external trigger input circuitry.

#### Parameter

Name	Type	Range	Default
<enum>	Discrete	{POSitive NEGative}	POSitive

#### Remarks

This command is only valid when the trigger source is External.

#### Return Format

The query returns POS or NEG.

#### Example

```
:TRIGger:SLOPe NEGative /*Sets the polarity expected by the
external trigger input circuitry to NEGative.*/
:TRIGger:SLOPe? /*The query returns NEG.*/
```

## 12.6 :TRIGger:CHANnel<cn>:AUXiliary<an>[:ENABLE]

#### Syntax

```
:TRIGger:CHANnel<cn>:AUXiliary<an>[:ENABLE] <bool>
```

```
:TRIGger:CHANnel<cn>:AUXiliary<an>[:ENABLE]?
```

#### Description

Enables or disables outputting the signal from the rear-panel trigger output connector.

Queries whether to output the signal from the rear-panel trigger output connector.

#### Parameter

Name	Type	Range	Default
<cn>	Integer	1 to 500	1
<an>	Integer	1	1
<bool>	Bool	{{1 ON}}{0 OFF}}	0 OFF

#### Remarks

- OFF (or 0): disables the trigger output.
- ON (or 1): enables the trigger output.

**Return Format**

The query returns 1 or 0.

**Example**

```
:TRIGger:CHANnel1:AUXiliary ON /*Enables the trigger output.*/
:TRIGger:CHANnel1:AUXiliary? /*The query returns 1.*/
```

## 12.7 :TRIGger:CHANnel<cn>:AUXiliary<an>:OPOLarity

**Syntax**

```
:TRIGger:CHANnel<cn>:AUXiliary<an>:OPOLarity <type>
```

```
:TRIGger:CHANnel<cn>:AUXiliary<an>:OPOLarity?
```

**Description**

Sets the polarity of the signal output from the rear-panel trigger output connector of VNA.

Queries the polarity of the signal output from the rear-panel trigger output connector of VNA.

**Parameter**

Name	Type	Range	Default
<cn>	Integer	1 to 500	1
<an>	Integer	1	1
<type>	Discrete	{POSitive NEGative}	NEGative

**Remarks**

- NEGative: VNA sends a negative pulse.
- POSitive: VNA sends a positive pulse.

**Return Format**

The query returns POS or NEG.

**Example**

```
:TRIGger:CHANnel1:AUXiliary:OPOLarity POSitive /*Sets the output
trigger signal to positive pulse.*/
:TRIGger:CHANnel1:AUXiliary:OPOLarity? /*The query returns
POS.*/
```

## 12.8 :TRIGger:CHANnel<cn>:AUXiliary<an>:POSition

### Syntax

```
:TRIGger:CHANnel<cn>:AUXiliary<an>:POSition <type>
```

```
:TRIGger:CHANnel<cn>:AUXiliary<an>:POSition?
```

### Description

Sets the trigger position of the output signal sent from the rear-panel trigger output connector.

Queries the trigger position of the output signal sent from the rear-panel trigger output connector.

### Parameter

Name	Type	Range	Default
<cn>	Integer	1 to 500	1
<an>	Integer	1	1
<type>	Discrete	{BEFore AFTer}	AFTer

### Remarks

- BEFore: triggers before the data is acquired.
- AFTer: triggers after data has been acquired. This could be more efficient since it allows the external device to get ready for the next acquisition at the same time as the VNA.

### Return Format

The query returns BEF or AFT.

### Example

```
:TRIGger:CHANnel1:AUXiliary:POSition BEFore /*Sets to trigger
before the data is acquired.*/
:TRIGger:CHANnel1:AUXiliary:? /*The query returns BEF.*/
```

## 12.9 :TRIGger:CHANnel<cn>:AUXiliary<an>:INTerval

### Syntax

```
:TRIGger:CHANnel<cn>:AUXiliary<an>:INTerval <type>
```

```
:TRIGger:CHANnel<cn>:AUXiliary<an>:INTerval?
```

**Description**

Sets the interval for the VNA to output the signal from the rear-panel trigger output connector.

Queries the interval for the VNA to output the signal from the rear-panel trigger output connector.

**Parameter**

Name	Type	Range	Default
<cn>	Integer	1 to 500	1
<an>	Integer	1	1
<type>	Discrete	{POINT SWEep}	SWEep

**Remarks**

- POINT: sends the trigger signal when acquiring each data point.
- SWEep: sends the trigger signal at each sweep.

**Return Format**

The query returns POIN or SWE.

**Example**

```
:TRIGger:CHANnel1:AUXiliary:INTerval POINT /*Sets to send a trigger
signal when acquiring each data point.*/
:TRIGger:CHANnel1:AUXiliary:INTerval? /*The query returns POIN.*/
```

## 12.10 :TRIGger:CHANnel<cn>:AUXiliary<an>:DURation

**Syntax**

```
:TRIGger:CHANnel<cn>:AUXiliary<an>:DURation <value>
```

```
:TRIGger:CHANnel<cn>:AUXiliary<an>:DURation?
```

**Description**

Sets the pulse width of the signal output from the rear-panel trigger output connector of VNA.

Queries the pulse width of the signal output from the rear-panel trigger output connector of VNA.

**Parameter**

Name	Type	Range	Default
<cn>	Integer	1 to 500	1
<an>	Integer	1	1
<value>	Real	1 $\mu$ s to 1 s	1 $\mu$ s

**Remarks**

N/A

**Return Format**

The query returns the pulse width of the output trigger signal. The unit is s.

**Example**

```
:TRIGger:CHANnel1:AUXiliary:DURation 0.1 /*Sets the pulse width  
of the output trigger signal to 0.1 s.*/  
:TRIGger:CHANnel1:AUXiliary:DURation? /*The query returns  
+1.00E-01.*/
```

## 13 :TAS Commands

To run the :TAS commands, install the test automation option first.

### 13.1 :TAS:STATE

#### Syntax

```
:TAS:STATE <bool>
```

```
:TAS:STATE?
```

#### Description

Enables or disables the TAS state; queries whether the TAS state is enabled.

#### Parameter

Name	Type	Range	Default
<bool>	Bool	{{1 ON}}{0 OFF}}	0 OFF

#### Return Format

The query returns 1 or 0.

#### Example

```
TAS:STATE ON /*Enables the TAS state.*/
:TAS:STATE? /*The query returns 1.*/
```

### 13.2 :TAS:PATH

#### Syntax

```
:TAS:PATH <string>
```

```
:TAS:PATH?
```

#### Description

Sets or queries the TAS test report path.

#### Parameter

Name	Type	Range	Default
<string>	ASCII String	Path	-

**Remarks**

N/A

**Return Format**

The query returns the TAS test report path in strings.

**Example**

```
:TAS:PATH /data/UserData/tmp /*Sets the TAS test report path to /
data/UserData/tmp*/
:TAS:PATH? /*The query returns /data/UserData/tmp.*/
```

## 13.3 :TAS:DUT

**Syntax**

:TAS:DUT <string>

:TAS:DUT?

**Description**

Set or query the TAS test sample name.

**Parameter**

Name	Type	Range	Default
<mn>	Integer	1 to 50000	1
<string>	ASCII String	-	-

**Remarks**

N/A

**Return Format**

The query returns the TAS test sample name in strings, separated by commas.

**Example**

```
:TAS:DUT test1 /*Sets the TAS test sample name to test1.*/
:TAS:DUT? /*The query returns test1.*/
```

## 13.4 :TAS:DUTConfig

**Syntax**

:TAS:DUTConfig <string>

:TAS:DUTConfig?

**Description**

Sets or queries the TAS configuration file.

**Parameter**

Name	Type	Range	Default
<mn>	Integer	1 to 50000	1
<string>	ASCII String	-	-

**Remarks**

N/A

**Return Format**

The query returns the TAS configuration files in strings, separated by commas.

**Example**

```
:TAS:DUTConfig test1 /*Sets the TAS configuration file to test1.*/  
:TAS:DUTConfig? /*The query returns test1.*/
```

## 14 Other Commands

### 14.1 :CONTrol:AUXiliary:PASSfail:POLicy

#### Syntax

```
:CONTrol:AUXiliary:PASSfail:POLicy <type>
:CONTrol:AUXiliary:PASSfail:POLicy?
```

#### Description

Sets the policy used to determine how global pass/fail is computed.

Queries the policy used to determine how global pass/fail is computed.

#### Parameter

Name	Type	Range	Default
<type>	Discrete	{ALLTests ALLMeas}	ALLTests

#### Remarks

- **ALLTests:** The query returns PASS if all tests on all measurements pass.
- **ALLMeas:** The query returns PASS if all measurements have associated tests, and all tests pass. The query returns FAIL if even one measurement has no associated limit test.

Only those measurements which are not in Trace Hold

(*:CALCulate<cn>:MEASure<mn>:HOLD:TYPE*) state contribute to the pass/fail result.

#### Return Format

The query returns ALLT or ALLM.

#### Example

```
:CONTrol:AUXiliary:PASSfail:POLicy ALLMeas /*Sets the policy used
to determine how global pass/fail is computed to ALLMeas.*/
:CONTrol:AUXiliary:PASSfail:POLicy? /*The query returns ALLM.*/
```

### 14.2 :OUTPut[:STATe]

#### Syntax

```
:OUTPut[:STATe] <bool>
:OUTPut[:STATe]?
```

**Description**

Enables or disables RF power output; or queries the status of RF power output.

**Parameter**

Name	Type	Range	Default
<bool>	Bool	{{1 ON}} {{0 OFF}}	1 ON

**Remarks**

- **ON:** enables the RF power output.
- **OFF:** disables the RF power output.

**Return Format**

The query returns 1 or 0.

**Example**

```
:OUTP OFF /*Disables the RF power output.*/
:OUTP? /*The query returns 0.*/
```

## 14.3 :INITiate<cn>[:IMMediate]

**Syntax**

```
:INITiate<cn>[:IMMediate]
```

**Description**

Sends a manual trigger signal, not affecting the current on-going sweep.

**Parameter**

Name	Type	Range	Default
<cn>	Integer	1 to 500	1

**Remarks**

To perform this command, you need to run the *:TRIGger[:SEquence]:SOURce* command to set the trigger source to Manual first. Each time you perform this command, a trigger signal is sent.

**Return Format**

N/A

**Example**

N/A

## 14.4 :ABORt

---

### Syntax

:ABORt

### Description

Aborts all sweeps, then resume trigger based on current trigger settings.

### Parameter

N/A

### Remarks

N/A

### Return Format

N/A

### Example

N/A

## 15 Programming Examples

---

This chapter illustrates how to control the instrument by programming in Excel, LabVIEW, Visual Basic, and Visual C++. These examples are programmed based on Virtual Instrument Software Architecture (VISA) library.

RIGOL official website (<http://www.rigol.com>) provides the programming examples based on LabVIEWk, Visual Basic, Visual C++, Matlab, and Python. You can go to the official website and click **SUPPORT** > **Programming Demo** to obtain the programming examples.

### 15.1 Programming Preparations

---

Before programming, you need to prepare the following tasks:

You can log in to the RIGOL official website (<http://www.rigol.com>) to download the software. Then install the software according to the installation wizard. After Ultra Sigma is installed successfully, NI-VISA library will be completely installed automatically. In this manual, the default installation path is C:\Program Files\IVI Foundation\VISA.

In the manual, the instrument communicates with the PC via the USB interface. Connect the USB Device interface on the rear panel of the instrument to the PC by using the USB cable. After the instrument is properly connected to the PC, power on the instrument to start it.

The following parts will make a detailed introduction about the programming examples in Excel, LabVIEW, Visual Basic, and Visual C++.

### 15.2 Excel Programming Examples

---

**Program used in this instance:** Microsoft Excel 2010

**Function realized in this example:** sending the \*IDN? command and reading the instrument information.

1. Open a new Macro-enabled Excel file and name it "Demo\_Excel.xlsm" in this example.
2. Run the Demo\_Excel.xlsm file. Click **File** > **Options** at the upper-left corner of the Excel file to open the interface as shown in the figure below. Click **Customize Ribbon** at the left, check **Developer** and click **OK**. At this point, the Excel menu bar displays the **Developer** menu.

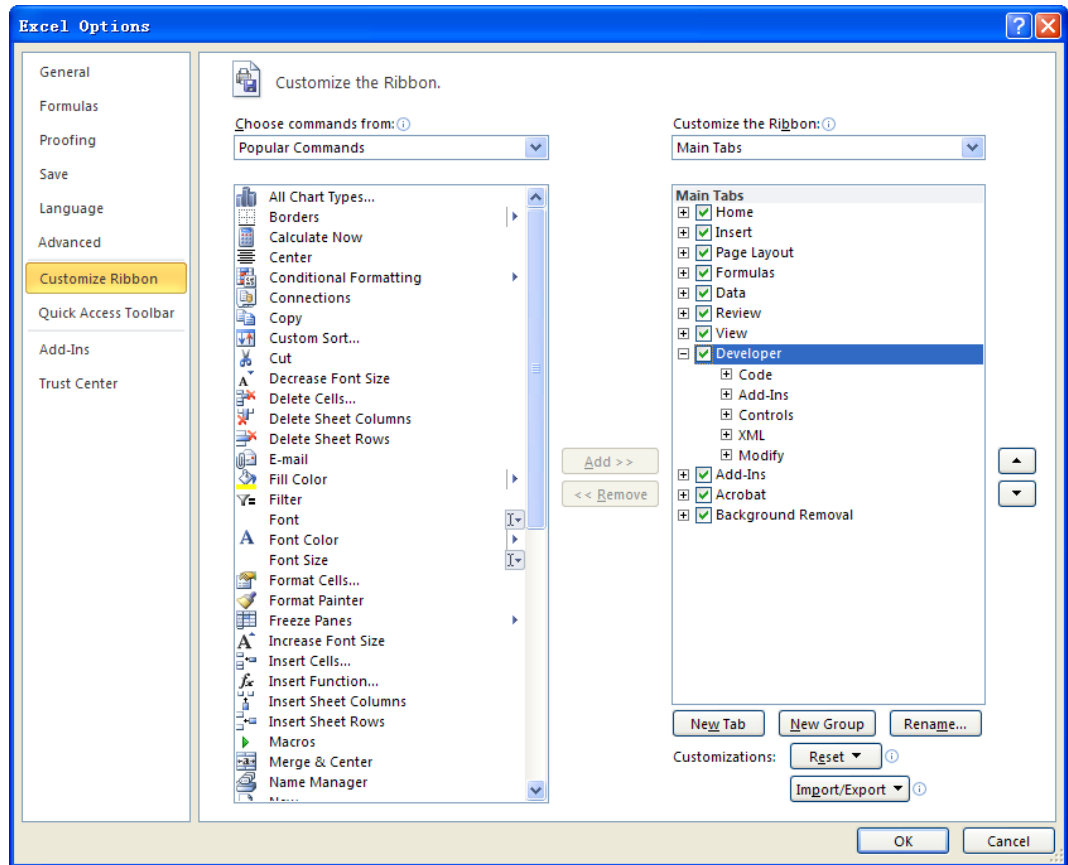

3. Enter a device resource descriptor into a cell of the file as shown in the figure below. For example, the device resource descriptor is `USB0::0x1AB1::0x0600::DS7F910400000::INSTR`. Input it into SHEET1.CELLS(1,2) (i.g. the B1 cell in Sheet1). Click the **Developer** menu and select the **Visual Basic** option to open the Microsoft Visual Basic.

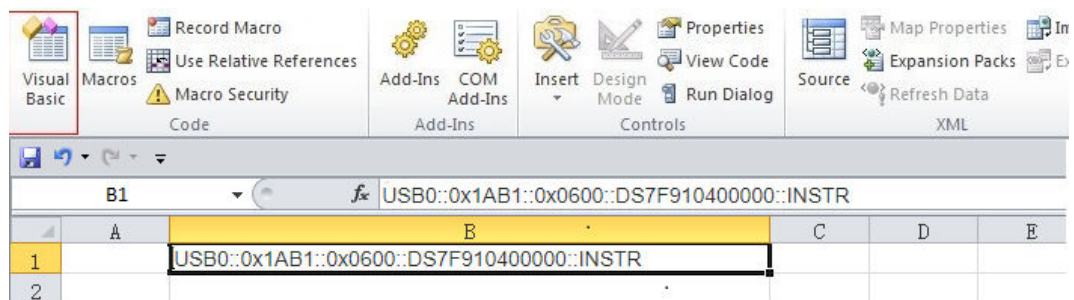

4. Select **Tools(T)** in the Microsoft Visual Basic menu bar and click **References**.

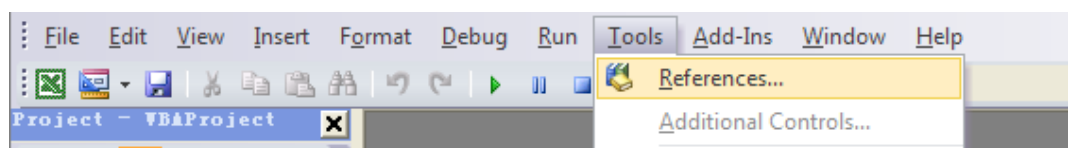

In the displayed dialog box, select **VISA Library**, and click **OK** to refer to VISA Library.

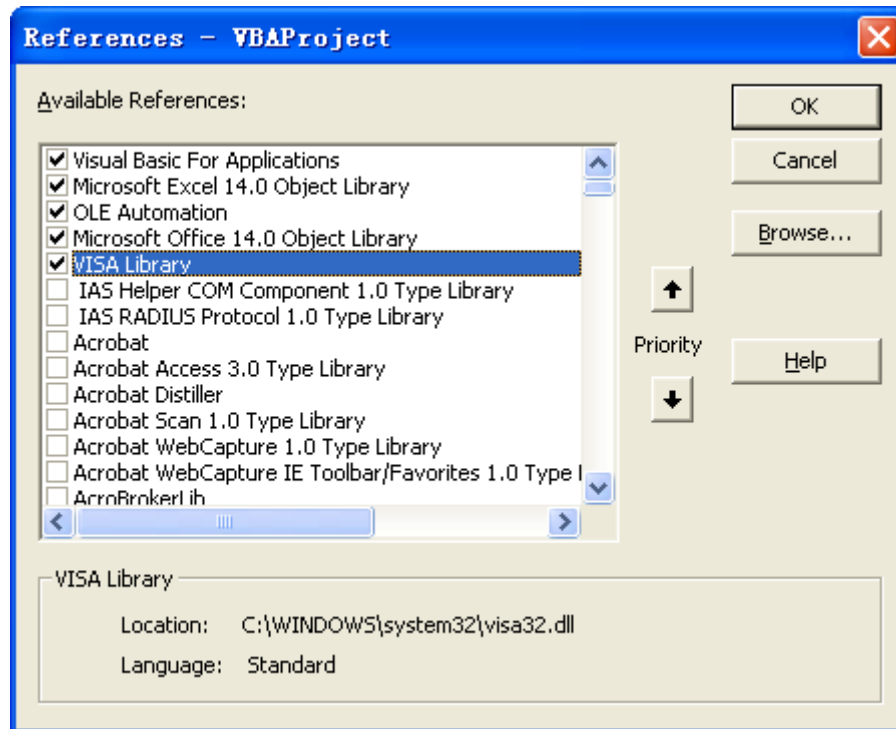

If you cannot find **VISA Library** in the left section of the above dialog box, please follow the method below to find it.

- a. Make sure that your PC has installed the NI-VISA library.
- b. Click **Browse...** at the right section to search visa32.dll from C:\WINDOWS\system32, as shown in the figure below.

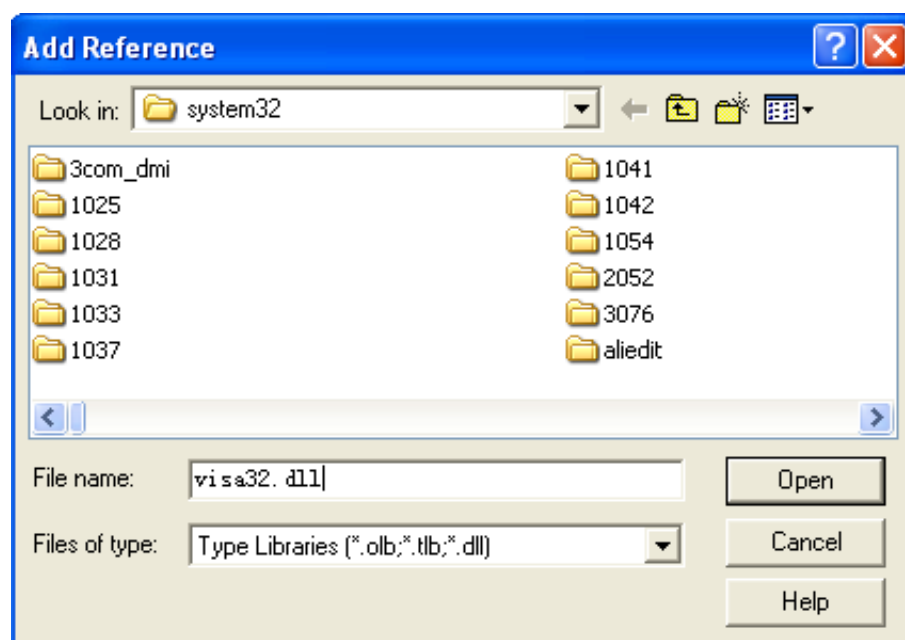

- Click **View Code** under **Developer** menu to enter the interface of Microsoft Visual Basic. Add the following codes and save it.



### CAUTION

If the Excel file created in Step 2 does not enable the Macros, a prompt message “The following features cannot be saved in macro-free workbooks” will be displayed. In this case, please save the file as a macro-enabled file type (filename with a suffix of “.xlsm”).

```
Sub QueryIdn()

    Dim viDefRm As Long
    Dim viDevice As Long
    Dim viErr As Long
    Dim cmdStr As String
    Dim idnStr As String * 128
    Dim ret As Long
    'Turn on the device, and the device resource descriptor is in
    CELLS(1,2) of SHEET1'
    viErr = visa.viOpenDefaultRM(viDefRm)
    viErr = visa.viOpen(viDefRm, Sheet1.Cells(1, 2), 0, 5000,
viDevice)

    'Send request, read the data, and the return value is in
    CELLS(2,2) of SHEET1'
    cmdStr = "*IDN?"
    viErr = visa.viWrite(viDevice, cmdStr, Len(cmdStr), ret)
    viErr = visa.viRead(viDevice, idnStr, 128, ret)
    Sheet1.Cells(2, 2) = idnStr

    'Turn off the device'
    visa.viClose (viDevice)
    visa.viClose (viDefRm)

End Sub
```

- Add the button control. Click **Insert** under the **Developer** menu, and select a button control under the **Form Controls** menu item and put it into the Excel cell. At this time, the **Assign Macro** dialog box is displayed, select "Sheet1.QueryIdn" and click **OK**.

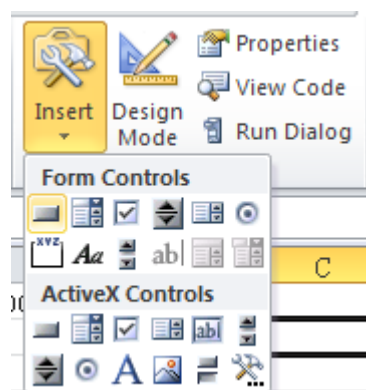

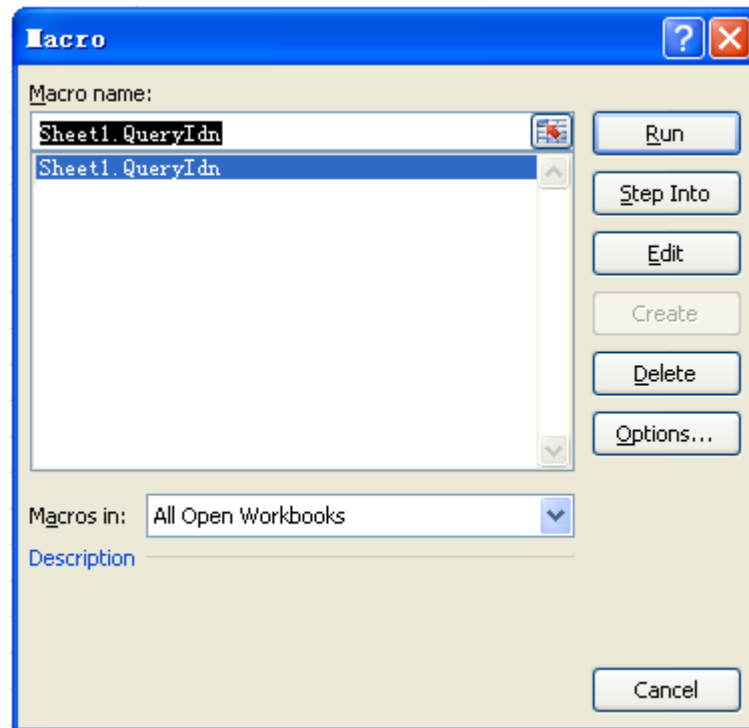

The default name of the button is "Button1". Right-click the button and select **Edit Text** in the pop-up menu to change the button name to "\*IDN?".

7. Click the "\*IDN?" button to send request and read data. The returned value is in CELLS(2,2) of SHEET1.

## 15.3 LabVIEW Programming Example

**Program used in this example:** LabVIEW2010

**Function realized in this example:** reading the waveform data of CH1 on the screen.

1. Run LabVIEW, and then create a VI file named LabVIEW\_Demo.
2. Add controls and create the front panel as shown in the figure below.

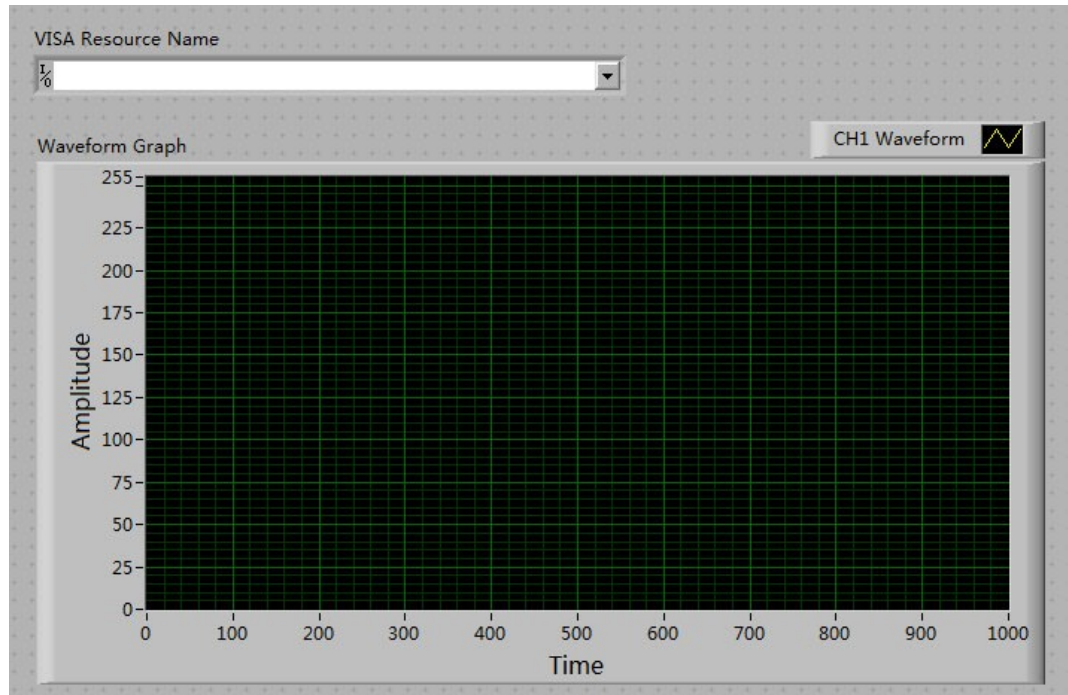

3. Open the Block Diagram panel. Click **Instrument I/O** > **VISA**. Add the following functions: VISA Open, VISA Read, VISA Write, and VISA Close.

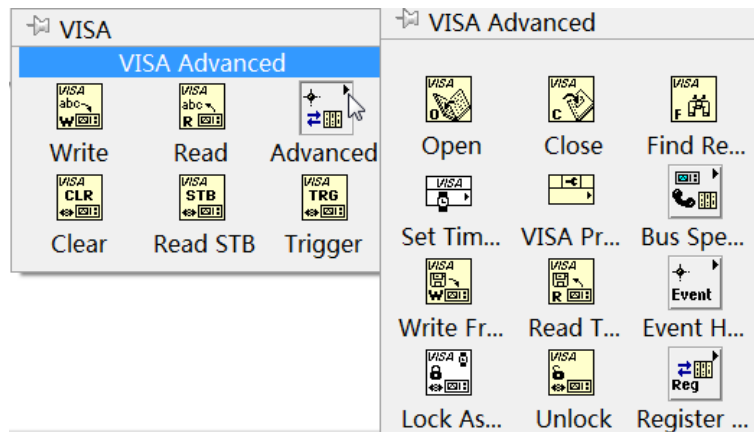

4. Change the default **Asynchronous** to **Synchronous**.

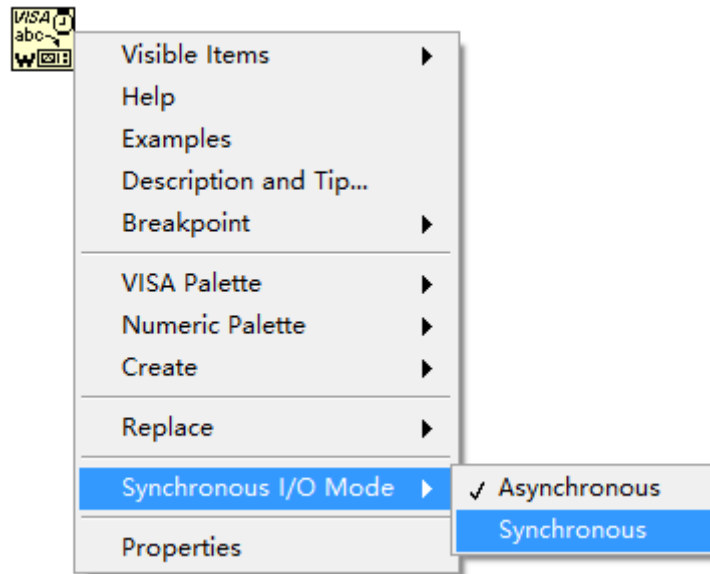

5. Connect the VISA resource name with the VISA Open. Then, connect the VISA resource name outputs of all the functions with the VISA resource name and connect the error output with the error input, as shown in the figure below.

VISA Resource Name



6. Add string constant in the write buffer areas of the VISA Write function and input the following instructions in the figure below. Waveform data is read through the VISA Read function which requires users to input the total number of bytes to be read. In this example, the total number of bytes of waveform data to be read is less than 2048. Use the VISA Close function to close the VISA resource after the VISA operation is finished.

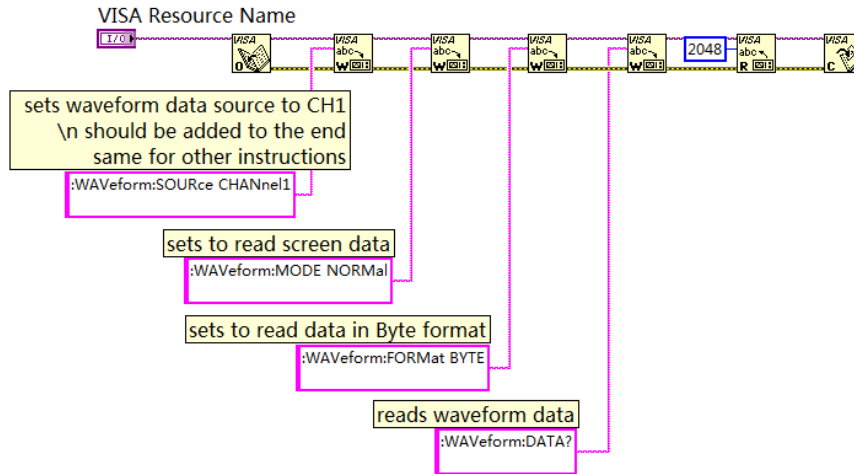

7. The data format is TMC data block header + waveform data + terminator. The TMC header is in #NXXXXXX format; wherein, # is the TMC header identifier; N following # represents the length of the waveform data; the length of the waveform data points is expressed in ASCII strings, and the terminator represents the ending of communication. For example, the data read for one time is #9000001000XXXX. It indicates that 9 bytes are used to describe the data length. 000001000 indicates the length of waveform data, that is, 1,000 bytes. Use the following block diagram to obtain the number of bytes that the TMC header occupies. Ignore the TMC header and delete the terminator at the end of the waveform data, and transfer the waveform data to the byte data and display it on the waveform diagram controls.

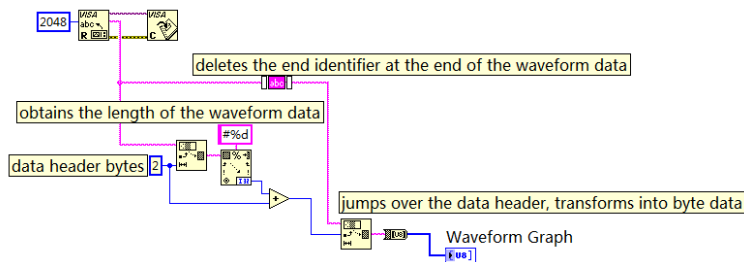

The available functions used in the above block diagram as follows:

**String Subset**

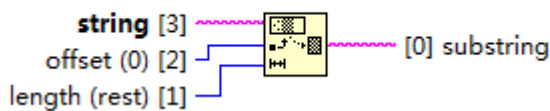

Used to obtain the TMC header"#N". After obtaining the number of bytes that the TMC header occupies, ignore the data header to obtain the waveform data strings

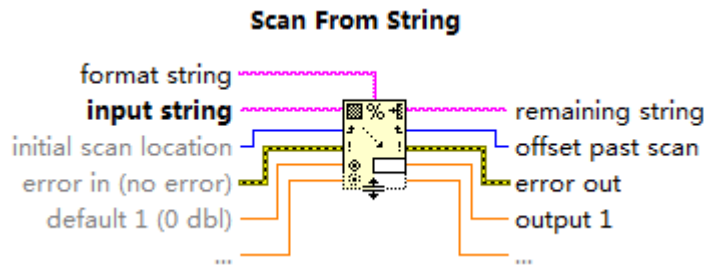

Used to obtain the waveform data length bytes

**Trim Whitespace.vi (4803)**

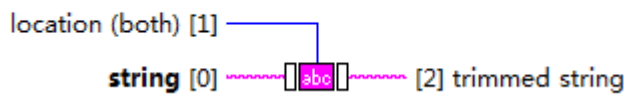

Used to delete the terminator at the end of the waveform data

**String To Byte Array**



Used to transfer waveform data strings to the byte group

8. The complete program block diagram is as shown in the figure below:

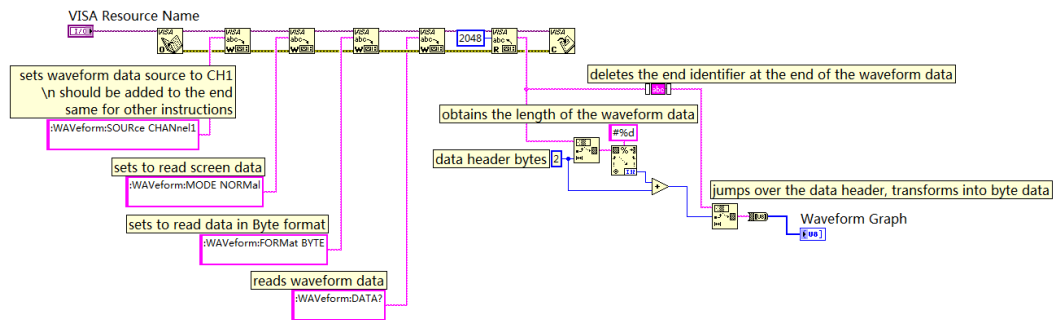

9. Select the device resource from the VISA Resource Name drop-down list and run the program.

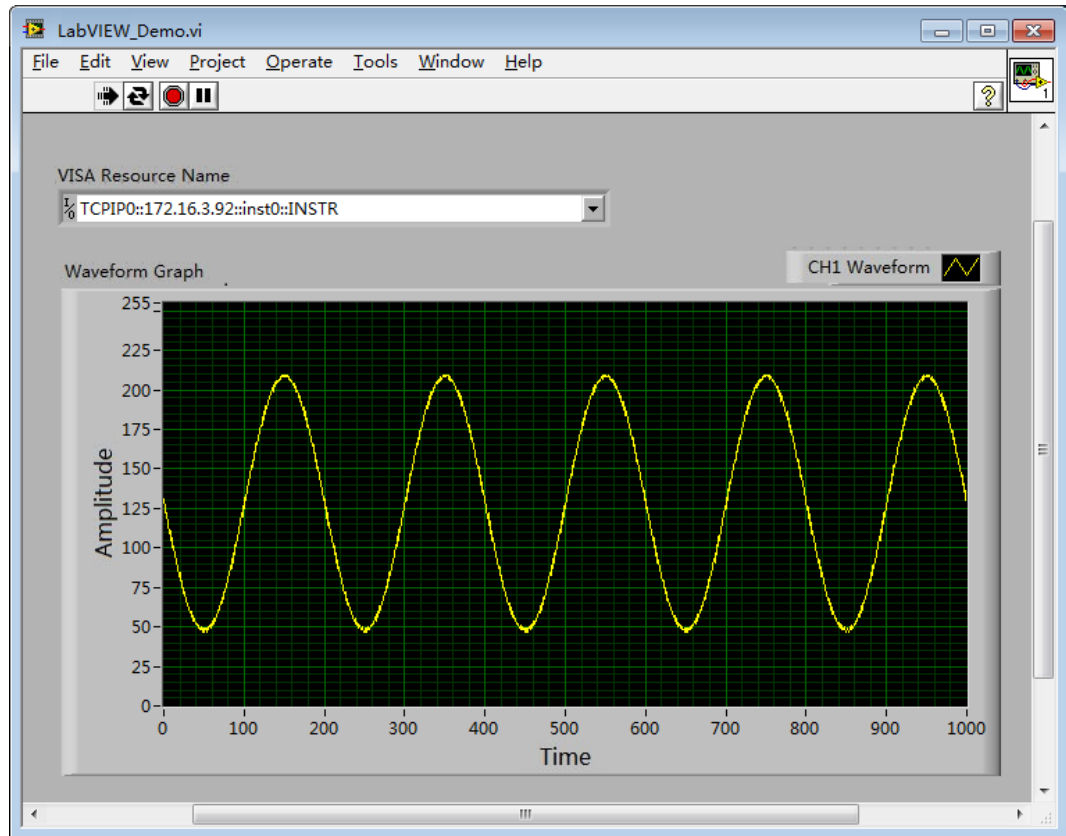

## 15.4 Visual Basic Programming Example

**Program used in this example:** Visual Basic 6.0

**Function realized in this example:** control the on/off state of any channel.

Enter the Visual Basic 6.0 programming environment, and perform the following procedures.

1. Build a standard application program project (Standard EXE), and name it "Demo".
2. Click **Project** > **Add Module** to open the Add Module dialog box. In the dialog box, click the Existing tab to search for the **visa32.bas** file in the include folder under the NI-VISA installation path and add the file.

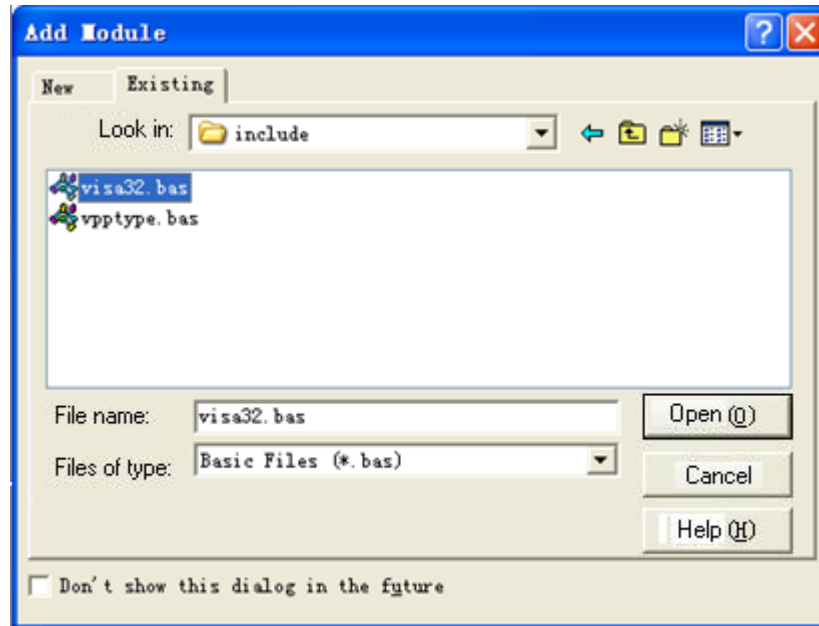

3. In the Demo dialog box, add four buttons to represent CH1 to CH4 respectively. Add four Labels (Label1(0), Label1(1), Label1(2), Label1(3)) to represent the statuses of CH1 to CH4 respectively (when the channel is enabled, it displays the color of the channel; when the channel is disabled, it displays gray), as shown in the figure below.

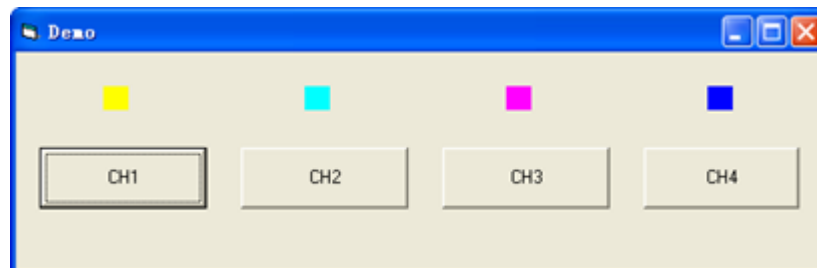

4. Click **Project** > **Project1 Properties** to open the Project1 – Project Properties dialog box. In the dialog box, click on the General tab and select **Form1** from the drop-down list under Startup Object.
5. Double-click CH1 to enter the programming environment. Add the following codes to control CH1-CH4. The codes of CH1 are as shown below; the codes of the other channels are similar.

```
Dim defrm As Long
Dim vi As Long
Dim strRes As String * 200
Dim list As Long
Dim nmatches As Long
Dim matches As String * 200 'Reserve the obtained device number
Dim s32Disp As Integer
' Obtain the usb resource of visa
Call viOpenDefaultRM(defrm)
Call viFindRsrc(defrm, "USB?*\"", list, nmatches, matches)
' Turn on the instrument
Call viOpen(defrm, matches, 0, 0, vi)
```

```

' Send a command to query the status of CH1
Call viVPrintf(vi, ":CHAN1:DISP?" + Chr$(10), 0)
' Obtain the status of CH1
Call viVScanf(vi, "%t", strRes)
s32Disp = CInt(strRes)
If (s32Disp = 1) Then
' Send the setting command
Call viVPrintf(vi, ":CHAN1:DISP 0" + Chr$(10), 0)
Label1(0).ForeColor = &H808080 'Gray
Else
Call viVPrintf(vi, ":CHAN1:DISP 1" + Chr$(10), 0)
Label1(0).ForeColor = &HFFFF& 'Yellow
End If
' Close the resource
Call viClose(vi)
Call viClose(defrm)

```

6. Save and run the project to obtain a single exe program for demo. When the instrument is correctly connected to the PC, you can control the on/off status of any channel.

## 15.5 Visual C++ Programming Example

**Program used in this example:** Visual C++ 6.0

**Function realized in this example:** search for the instrument address, connect to the instrument, send commands, and read return values.

Enter the Visual C++ 6.0 programming environment, and perform the following procedures.

1. Create a MFC project based on a dialog box.
2. Click **Project > Settings** to open the **Project Setting** dialog box. In the dialog box, click the **C/C++** tab, select **Code Generation** from the drop-down list under **Category**. Choose **Debug Multithreaded DLL** from the drop-down list under **Use run-time library**. Click **OK** to close the dialog box.

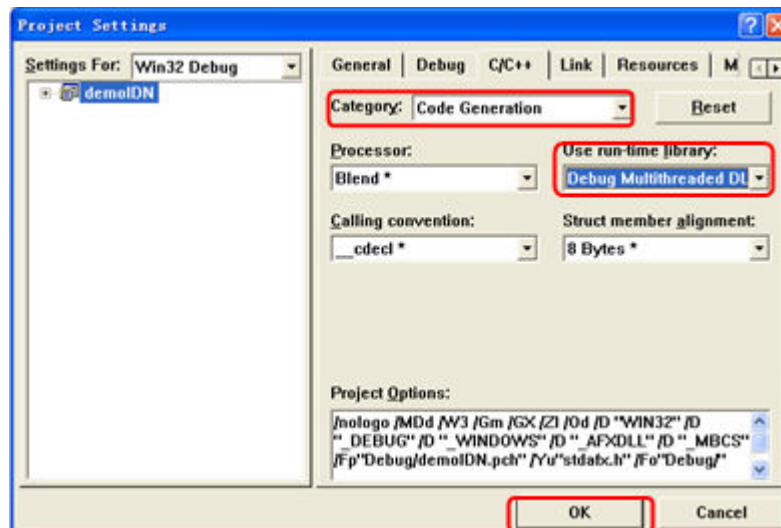

- Click **Project** > **Settings** to open the **Project Setting** dialog box. In the dialog box, click the **Link** tab, add "visa32.lib" under **Object/library modules**, then click **OK** to close the dialog box.

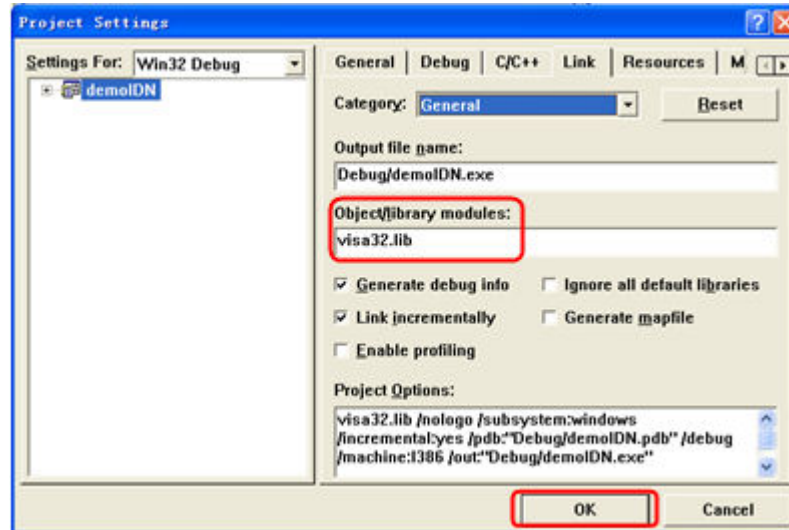

- Click **Tools** > **Options** to open the Options dialog box. Then click the **Directories** tab.

Select **Include files** from the drop-down list under **Show directories for**. Double click the empty space under **Directories** to enter the specified path of Include files: C:\Program Files\IVI Foundation\VISA\WinNT\include. Click **OK** to close the dialog box.

Select **Library files** from the drop-down list under **Show directories for**. Double click the empty space under **Directories** to enter the specified path of Library files: C:\Program Files\IVI Foundation\VISA\WinNT\lib\msc. Click **OK** to close the dialog box.

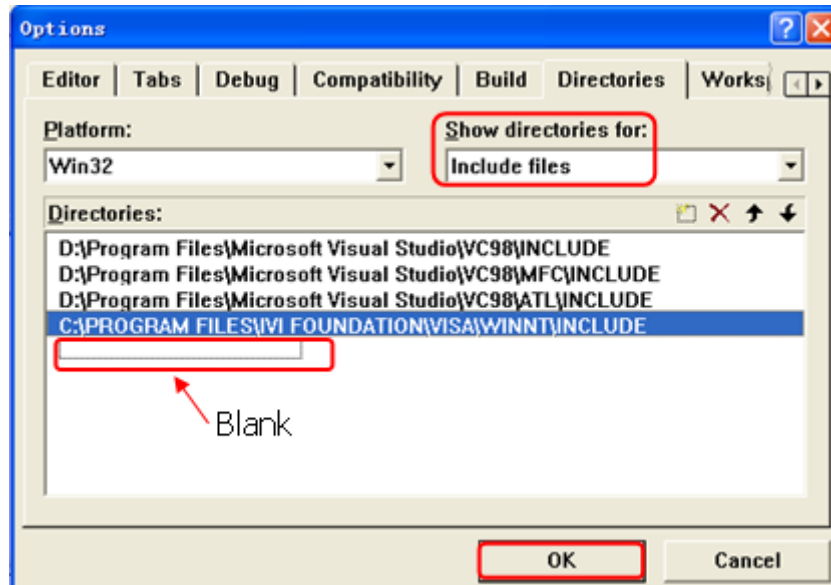

Note: By now, VISA library has been added.

5. Add the **Text**, **Combo Box**, **Button**, and **Edit Box** controls. The layout interface for adding controls is as follows:

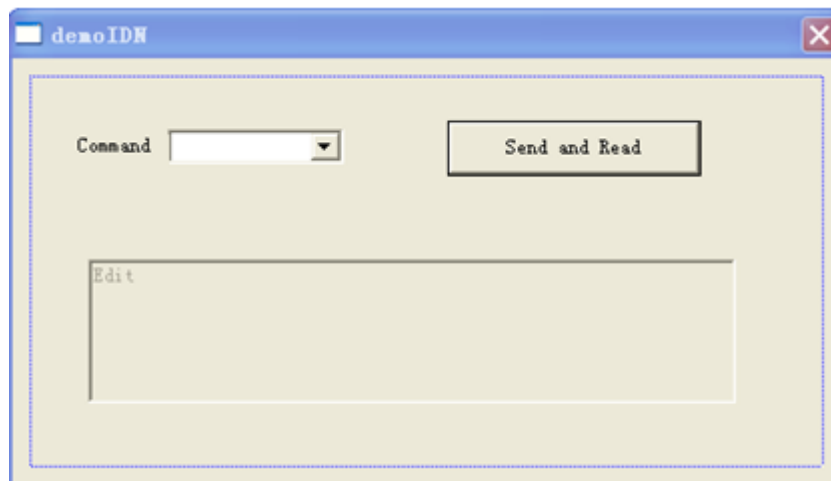

6. Modify the control attributes.
  - a. Name **Text** as "Command".
  - b. Open the **Data** item in the **Combo Box** attribute and input the following command \*IDN? manually.
  - c. Open the **General** item in the **Edit Box** attribute and select **Disabled**.
  - d. Name **Button** as **Send and Read**.

7. Add the variables `m_combox` and `m_receive` to the **Combo Box** and **Edit Box** controls respectively.

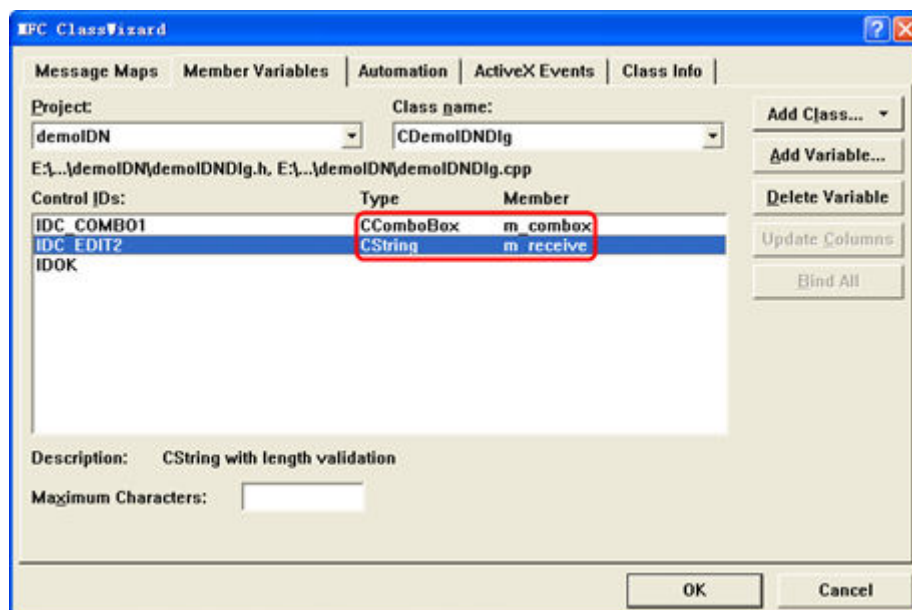
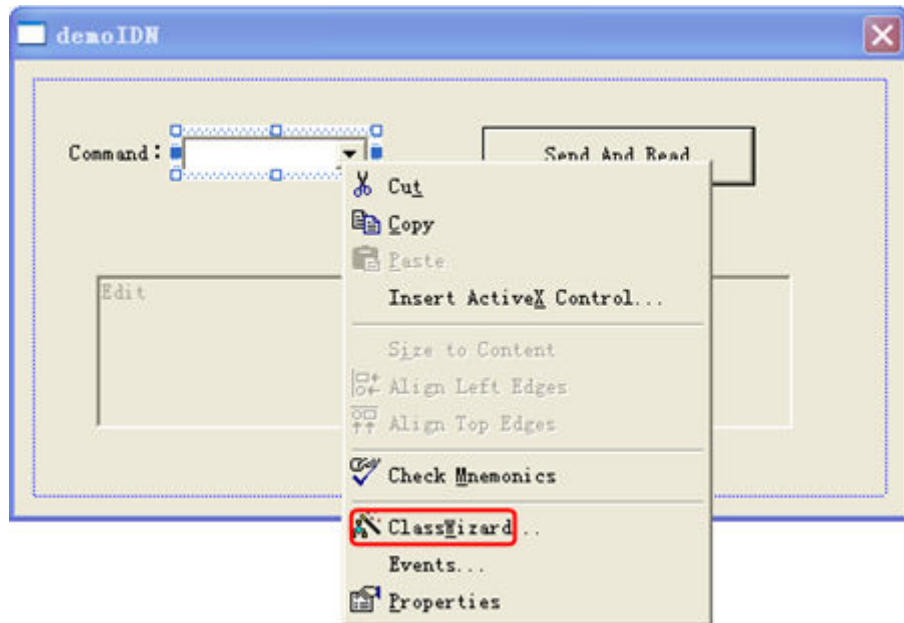

8. Add codes.

Double-click **Send and Read** to enter the programming environment. Declare the `#include <visa.h>` of the VISA library in the header file and then add the following codes:

```
ViSession defaultRM, vi;
char buf [256] = {0};
CString s, strTemp;
char* stringTemp;

ViChar buffer [VI_FIND_BUFLLEN];
```

```
ViRsrc matches=buffer;
ViUInt32 nmatches;
ViFindList list;

viOpenDefaultRM (&defaultRM);
//Acquire the USB resource of VISA
viFindRsrc(defaultRM, "USB?*",&list,&nmatches, matches);
viOpen (defaultRM,matches,VI_NULL,VI_NULL,&vi);

//Send the command received
m_combox.GetLBText(m_combox.GetCurSel(),strTemp);
strTemp = strTemp + "\n";
stringTemp = (char *) (LPCTSTR)strTemp;
viPrintf (vi,stringTemp);

//Read the results
viScanf (vi, "%t\n", &buf);

//Display the results
UpdateData (TRUE);
m_receive = buf;
UpdateData (FALSE);
viClose (vi);
viClose (defaultRM);
```

9. Save, compile, and run the project to obtain a single exe file. When the instrument is correctly connected to the PC, enter a command (for example, \*IDN?) and click **Send and Read** to execute the command. Then, the reading results will be returned.

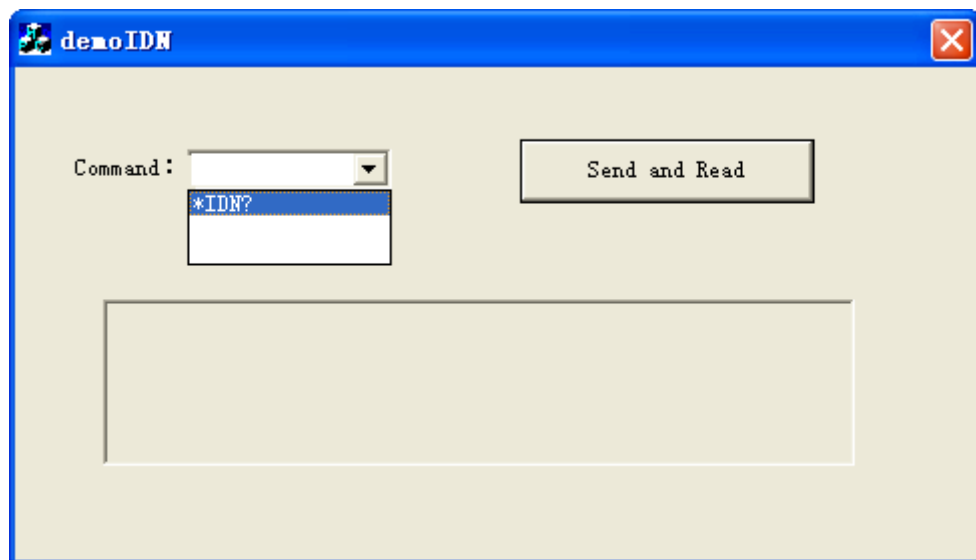

# Boost Smart World and Technology Innovation

Industrial Intelligent  
Manufacturing



Semiconductors

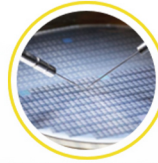

Education &  
Research

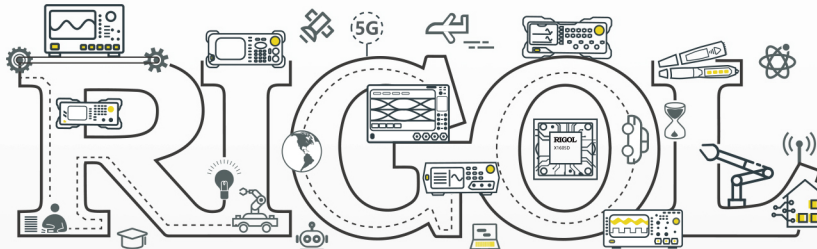

Communication

System Integration

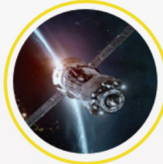

New Energy



- 5G Cellular-5G/WIFI
- UWB/RFID/ ZIGBEE
- Digital Bus/Ethernet
- Optical Communication

- Digital/Analog/RF Chip
- Memory and MCU Chip
- Third-Generation Semiconductor
- Solar Photovoltaic Cells

- New Energy Automobile
- PV/Inverter
- Power Test
- Automotive Electronics

*Provide Testing and Measuring Products  
and Solutions for Industry Customers*

## HEADQUARTER

**RIGOL TECHNOLOGIES CO., LTD.**  
No.8 Keling Road, New District,  
Suzhou, JiangSu, P.R.China  
Tel: +86-400620002  
Email: info-cn@rigol.com

## JAPAN

**RIGOL JAPAN CO., LTD.**  
5F, 3-45-6, Minamiotsuka, Toshima-Ku,  
Tokyo, 170-0005, Japan  
Tel: +81-3-6262-8932  
Fax: +81-3-6262-8933  
Email: info.jp@rigol.com

## EUROPE

**RIGOL TECHNOLOGIES EU GmbH**  
Friedrichshafener Str. 5  
82205 Gilching  
Germany  
Tel: +49(0)8105-27292-21  
Email: info-europe@rigol.com

## KOREA

**RIGOL KOREA CO., LTD.**  
5F, 222, Gonghang-daero,  
Gangseo-gu, Seoul, Republic of Korea  
Tel: +82-2-6953-4466  
Fax: +82-2-6953-4422  
Email: info.kr@rigol.com

## NORTH AMERICA

**RIGOL TECHNOLOGIES, USA INC.**  
10220 SW Nimbus Ave.  
Suite K-7  
Portland, OR 97223  
Tel: +1-877-4-RIGOL-1  
Email: sales@rigol.com

## For Assistance in Other Countries

Email: info.int@rigol.com