

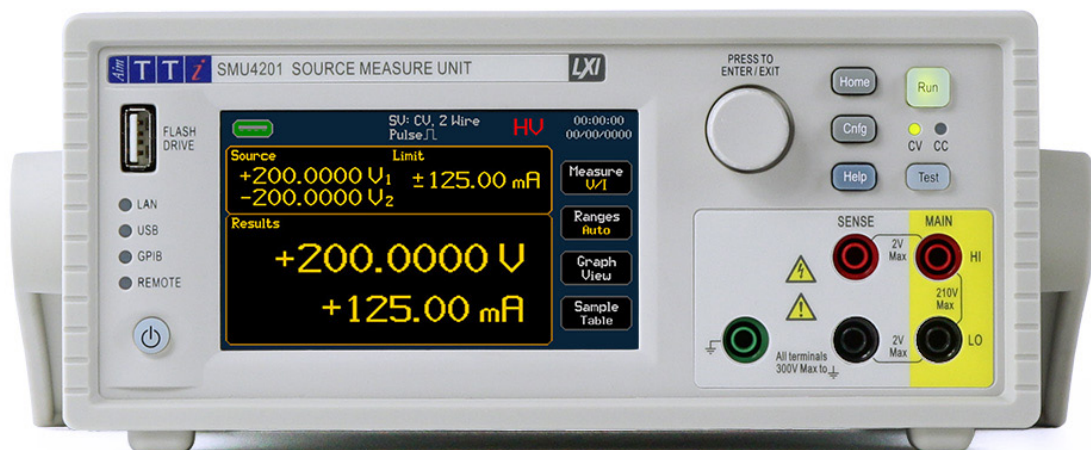

INSTRUCTION MANUAL

EN



SMU4000 SERIES

SOURCE MEASURE UNITS

CONTENTS

CONTENTS.....	1
1. Product description	4
2. Safety.....	5
Symbols.....	5
Safety notices	6
3. Installation	7
Mounting.....	7
Ventilation	7
Handle/stand	7
Electrical Requirements.....	8
Switching On	9
4. Instrument overview	10
Front Panel.....	10
Rear Panel.....	12
5. Introduction	14
Using this Manual	14
Navigation Controls	15
Home screen	17
6. Getting Started	19
Connections.....	19
High Voltage Interlock [SMU4201 only]	20
Basic operation.....	21
Selecting a Range	23
Measurement selection.....	25
Saving Data	26
Sample table.....	28
Measure Statistics	29
Graph.....	30
Graph Menu.....	31

CONTENTS

Graph view Menu	36
Storing and Loading Setup Files.....	37
Event log.....	40
7. Easy setup	41
Overview.....	41
8. Manual setup	42
Overview.....	42
Operating Mode.....	43
Source Modes	44
Load Modes.....	45
Measure Modes.....	48
Terminal selection.....	49
Measurement count.....	50
Source shape	51
Output off state	60
Source Control.....	62
Limits and Protection	64
Source Level.....	66
Timing options	67
Sequence mode	70
9. Digital I/O.....	77
Overview.....	77
10. Math Functions.....	79
Applying calculations to measurements	79
Measure.....	79
11. Result sorting	80
Tolerance.....	80
12. Application notes	81
Source- Measure considerations.....	81

CONTENTS

- PowerFlex..... 83
- 13. System management 84**
- 14. Maintenance..... 88**
 - Cleaning 88
- 15. Remote interfaces 89**
 - Overview..... 89
- 16. Calibration..... 90**
 - Measurement Zero and Self Calibration 90
 - Routine Calibration 90
- 17. Factory Default settings 91**
- 18. Specification 93**
 - Specification Conditions 93
 - Key Specifications of SMU4000 series..... 93
 - Output Power, Voltage and Current Capability 96
 - Protection 97
 - Measurement Result Buffer 97
 - Digital Input/Output (DIO) 98
 - Remote Control Interfaces..... 98
 - System Speeds 98
 - Environmental..... 99
 - Mechanical 99

1. PRODUCT DESCRIPTION



The SMU4000 (Source Measure Unit) Series provides class leading performance at a new and affordable price point for a four quadrant SMU. Combining touch screen technology with an intuitive graphical user interface provides a clear and natural flow through the test and measurement process.

Integrating a fast and agile, high power four quadrant voltage/ current source and advanced precise voltage/ current meters in a compact half rack 2U casing, capable of precisely supplying positive and negative voltages, sourcing or sinking power, while simultaneously measuring both current and voltage for I-V characterising.

With high current and power combined with fast measurements and low glitch auto ranging speed, it is the ideal solution for industrial development as well as educational environments, identifying the SMU as the all-in-one solution for simplifying test applications such as battery charging/discharging, I-V characterising, semiconductor testing and much more.

2 - Safety

Symbols

2. SAFETY

Symbols

This document provides safety information and warnings which must be followed by the user to ensure safe operation of the SMU4001 and SMU4201 and to keep the instrument in a safe condition. The Source Measure Units described in this document are designed to be used as general purpose test and measurement equipment. **Must not be used for measurements of Category II or higher mains circuits (as defined in IEC 60364)**



User manuals, additional support and service information can be found at:
www.aimtti.com/support

The following symbols are displayed on the instrument and throughout the manual, to ensure the safety of the user and the instrument, all information must be read before proceeding.

WARNING



Indicates a hazard that, if not avoided, could result in injury or death.

CAUTION



Indicates a hazard that could damage the product that may result in loss of important data or invalidation of the warranty.

NOTE



Indicates a helpful tip.

EXAMPLE



Indicates an example to show further details.

	Caution, possibility of electric shock		UKCA 'UK Conformity Assessed' marking is a certification mark that affirms conformity with the applicable requirements for products sold within Great Britain.
	Caution, possibility of damage		
	Earth (ground) terminal		'CE' marking is a certification mark that affirms the good's conformity with European health, safety, and environmental protection standards.
	Protective Earth terminal		
	Standby supply. Instrument is not disconnected from AC mains power when switch is off.		WEEE (do not dispose in household waste)
	Alternating current.		

2 - Safety

Safety notices

Safety notices

This instrument is:

- A safety Class I instrument according to IEC classification and has been designed to meet the requirements of EN61010-1 and EN61010-2-030 (Safety Requirements for Electrical Equipment for Measurement, Control and Laboratory Use).
- An Installation Category II instrument intended for operation from a normal single-phase supply.
- Supplied in a safe condition and tested in accordance with EN61010-1.
- Designed for indoor use in a Pollution Degree 2 environment in the temperature range 5°C to 40°C, 20% - 80% RH (non-condensing) and less than 2000m altitude.

WARNING



Do not operate while condensation is present.

Do not operate outside its rated supply voltages or environmental range.

THIS INSTRUMENT MUST BE EARTHED.

Any interruption of the mains earth connector, inside or outside, will make the instrument dangerous. Intentional interruption is prohibited.

Use of this instrument in a manner not specified by these instructions may impair the safety protection provided

If any adjustment or repair of the opened power supply under voltage is inevitable it shall be carried out only by a skilled person who is trained to perform such adjustments and is aware of the hazards involved.

When connected, terminals may be live and opening the covers or removal of parts (except those that can be accessed by hand) may expose live parts.

To avoid electric shock, or damage to the instrument, never allow water to get inside the case.

If the instrument is clearly defective, has been subject to mechanical damage, excessive moisture, or chemical corrosion the safety protection may be impaired and it must be withdrawn from use and returned for checking and repair.

Voltages above 60VDC are hazardous live according to EN 61010-1 and great care must be taken when using the SMU at voltages above this level.

Capacitors inside the SMU may still be charged even if it has been disconnected from all voltage sources, these will be safely discharged a few minutes after switching off. LEDs on the HV rail to indicate that charge is still present, as such it's not safe to dismantle until all LEDs have gone out.

This instrument is protected by three internal fuses which are user serviceable (refer to the Service Manual).

CAUTION



Do not wet when cleaning, use only a soft dry cloth to clean the screen.

Do not use sharp or pointed objects to operate the touch screen.

Take care not to restrict the inlet vents at the front, rear, sides or underneath the instrument. In rack-mounted situations, allow adequate space around the instrument.

3. INSTALLATION

Mounting

This instrument is suitable both for bench use and rack mounting.

For rack mounting the protective bezels and handle/stand should be removed such that the instrument can be fitted beside any other standard 2U half-rack instrument in a 19" rack. A suitable 2U 19" rack kit is available from the manufacturers or their overseas agents.

See rack mount instructions for details on how to remove the protective bezel and handle.

Ventilation

The instrument uses a fan fitted to the rear panel. Take care not to restrict the rear air exit or the inlet vents at the front (sides and underneath). In rack-mounted situations allow adequate space around the instrument and/or use a fan tray for forced cooling. If the air inlet vents are restricted for any reason, the fan can be set to 'fast' to compensate for minimal restrictions, see '*Air vents*' for more details.

Handle/stand

The instrument is fitted with a 4-position handle/stand. Pull out both sides of the handle at the case pivot points to free the position locking pegs and rotate the handle from the stowed position to the required stand or handle position. Release the sides of the handle to lock it in the new position.

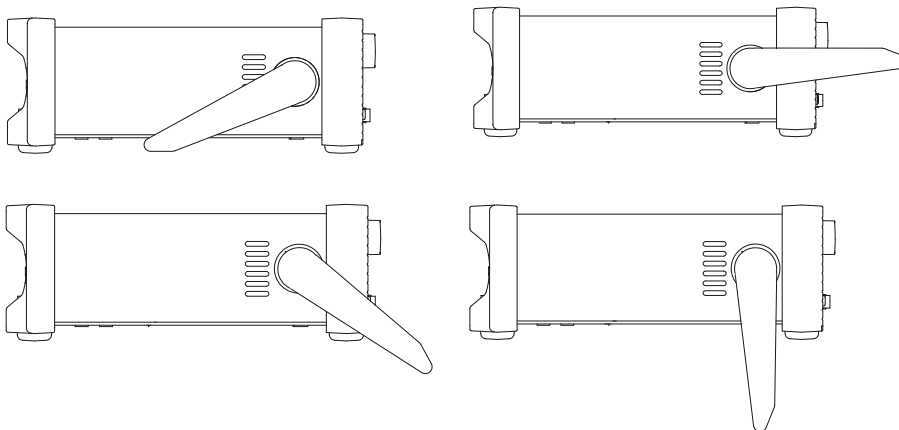

3 - Installation

Electrical Requirements

Electrical Requirements

Mains operating voltage

CAUTION



The operating voltage is switch selectable between 115Vac or 230Vac. You must check that the local supply meets the AC input printed on the rear panel before connecting the unit to the supply.

Changing the mains operating voltage

Should it be necessary to change the operating voltage from 230V to 115V or vice-versa, follow the instructions below:

WARNING



The apparatus must be disconnected from all voltage sources before it is opened for any adjustment. Capacitors inside the SMU may still be charged even if it has been disconnected from all voltage sources, these will be safely discharged a few minutes after switching off. LEDs on the HV rail to indicate that charge is still present, as such it's not safe to dismantle until all LEDs have gone out.

Remove the case:

- ① Position the handle as shown.

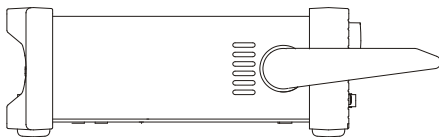

- ② Remove 2x screws from the rear panel.

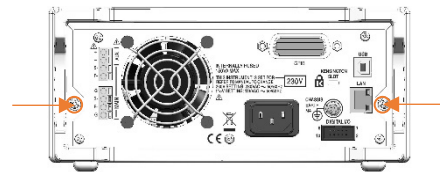

- ③ Slide and lift the case clear.

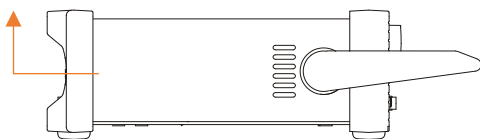

Mains supply voltage selection:

A switch is located in the highlighted position (SW1).

Select the required value with the switch and replace the case.

CAUTION



The set AC input voltage **MUST** be clearly labeled on the rear panel.

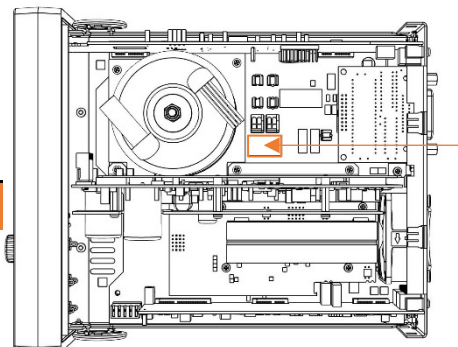

3 - Installation

Switching On

Mains lead

Connect the instrument to the AC supply using the mains lead provided.

Should a mains plug be required for a different mains outlet socket, a suitably rated and approved 3 core mains lead with protective earth conductor should be used which is fitted with the required wall plug and an IEC60320 C13 connector for the instrument end.

The minimum current rating of the lead-set for the intended AC supply is 6A or more.

WARNING



THIS INSTRUMENT MUST BE EARTHED.

Any interruption of the mains earth conductor inside or outside the instrument will make the instrument dangerous. Intentional interruption is prohibited.

Before use, inspect provided mains lead for any signs of damage. Do not use if lead is damaged.

Before use, inspect the instrument for any signs of damage. Do not use if damaged.

Switching On

Connect the instrument to the AC supply using the mains lead provided.

Press the standby button; the button will illuminate to indicate start up. At power-up the instrument will display a start-up message whilst initialising the application.

Loading takes a short while as the SMU will carry out self-testing and a self-calibration (at every power cycle), after which the home screen is displayed.

To switch off, press the standby button. When powered down into standby mode the LED is dimly lit, indicating mains power is still present.

WARNING



To fully disconnect from the AC supply, unplug the mains cord from the back of the instrument or switch off at the AC supply outlet; make sure that the means of disconnection is readily accessible. Disconnect from the AC supply when not in use.

4 - Instrument overview

Front Panel

4. INSTRUMENT OVERVIEW

Front Panel

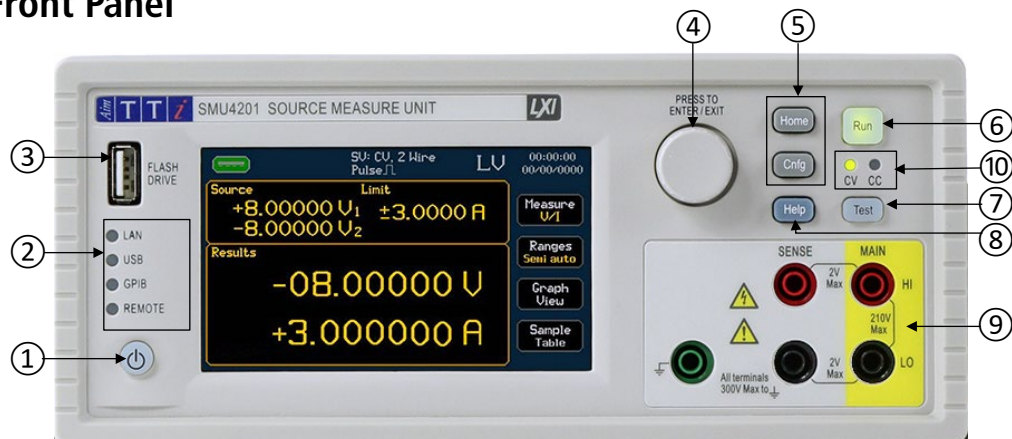

① Standby button

When pressed to power up the instrument, the button will illuminate to indicate start up.

CAUTION



When powered down into standby mode, mains power is still present.

Alternative power up options are available, see *'Power Control'* for more details.

② Remote Indicator LEDs

When the instrument is being controlled remotely, the remote indicator will be illuminated, either the LAN, USB or GPIB indicator will also be illuminated, depending on the communication type.

③ Flash Drive

This is a USB Host port for the connection of flash drives which conform to the Mass Storage Class specification and are formatted as FAT32.

Setups, sequences, and lists can be imported and exported via the flash drive port, see *'Storing and Loading Setup Files'* for more details.

Measurement data can be automatically recorded to the flash drive on completion of a test run, see *'Saving Data'* for more details.

Images of the display can be captured and exported using the flash drive port see *'Icons/indicators on the status bar'* for more details

④ Rotary Knob

The rotary knob is used to navigate the user interface and scroll through values- it features a 'press' function to select an option, see *'Basic operation'* for more details.

⑤ Menu Keys

- HOME- Returns to the home screen, see *'Home screen'* for more details.
- CNFG- Accesses the main menu configuration screen

4 - Instrument overview

Front Panel

⑥ Run Key

The Run key enables the output and executes the present configuration.

⑦ Test Key

The Test key performs a quick internal self-calibration and measurement zero. See 'Zero Calibration' for more details.

⑧ Help Key

The context sensitive help key provides direct assistance with menus, settings, and parameters.

⑨ Terminals

The front input terminals are 4mm safety sockets on a 19mm pitch designed to accept 4mm safety plugs with fixed or retractable shrouds.

WARNING



Only ever use either the front or rear terminals, never use both at once. Hazardous voltages will appear on both sets of terminals.

SMU4201 Front and Rear Terminal Blocks, Main/ Force(F), Sense(S) and Guard(G) can be set and operate at voltages up to 210Vpeak. Voltages greater than 60V are deemed hazardous voltages.

Only use test leads conforming to IEC61010-031.

Always make connections to the instrument with the OUTPUT off and in the Open off state; this is the only output state that completely isolates the external circuitry from the instrument.

CAUTION



All terminals are rated to 300Vpeak with respect to earth ground. Safety will be maintained if voltages up to 21Vpeak for SMU4001 or 210Vpeak for SMU4201, are accidentally applied between inappropriate terminals in excess of their marked ratings. The maximum differential between MAIN HI and SENSE HI and MAIN LO and SENSE LO should be < 2Vpeak. The SENSE terminals are protected against accidental connection of up to 21Vpeak for SMU4001 or 210Vpeak for SMU4201 between HI & LO.

Main- Main Terminals source or sink voltage or current.

Sense- Sense terminals measure voltage. The HI Sense terminal can be used as a guard in 2 Wire + Guard setups. 4 Wire setups use the HI & LO Sense plus the HI & LO Main terminals.

Ground- chassis ground for ground reference purposes only. See 'Terminal selection' for more details.

⑩ CV / CC LED indicator

When the output is running, the CV/ CC indicators show whether the instrument is in Constant Voltage or Constant Current.

4 - Instrument overview

Rear Panel

Rear Panel

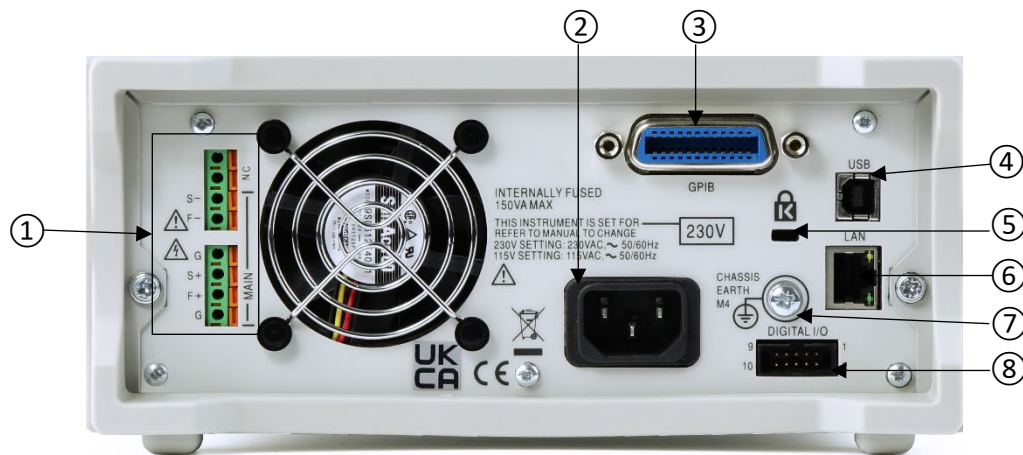

① Terminal Block

The terminal block provides rear access to the Main and Sense connections with the addition of Guard connections.

To connect a wire, press the orange actuators of the screwless terminals, insert the connecting wire and release the actuator to secure the connection.

Use insulated wire (solid or stranded, 0.5mm² to 1.5mm² (21 to 16AWG), strip length 9mm to 10mm) suitable to meet local safety standard for 300Vpeak, i.e. tri-rated 600V equipment wire with uninsulated ferrule. Ensure there are no loose strands.

WARNING



Only ever use either the front or rear terminals, never use both at once. Hazardous voltages will appear on both sets of terminals.

SMU4201 Front and Rear Terminal Blocks, Main/ Force(F), Sense(S) and Guard(G) can be set and operate at voltages up to 210Vpeak. Voltages greater than 60V are deemed hazardous voltages.

Only use test leads conforming to IEC61010-031.

Always make connections to the instrument with the OUTPUT off and in the Open off state; this is the only output state that completely isolates the external circuitry from the instrument.

CAUTION



All terminals are rated to 300Vpeak with respect to earth ground. Safety will be maintained if voltages up to 21Vpeak for SMU4001 or 210Vpeak for SMU4201, are accidentally applied between inappropriate terminals in excess of their marked ratings. The maximum differential between FORCE HI and SENSE HI and FORCE LO and SENSE LO should be < 2Vpeak. The SENSE terminals are protected against accidental connection of up to 21Vpeak for SMU4001 or 210Vpeak for SMU4201 between HI & LO.

F +/- [Force]- Force terminals source or sink voltage or current, they are permanently wired in parallel with the front panel Main HI and LO terminals.

4 - Instrument overview

Rear Panel

S +/- [Sense]- Sense terminals measure voltage and are permanently wired in parallel with the front panel SENSE HI and LO terminals. 4 Wire setups use the HI & LO Sense plus the HI & LO FORCE terminals.

WARNING



G [Guard] terminals

Dedicated Guard terminals only feature on the rear panel.

The Guard signal driven to the same potential as the FORCE HI. As such, if the FORCE HI is at a hazardous voltage, the same hazardous voltage level will also be present at the Guard.

See '*Terminal selection*' for more details.

② AC power inlet

The instrument must be connected to AC mains using the power lead provided. When the power lead is connected this lead provides the necessary protective earth connection to an external protective earth system. See '*Electrical Requirements*' for more details.

③ GPIB (optional)

For GPIB connection the SMU Requires a GPIB 1A user retrofittable option, available from the manufacturers or their agents. The default GPIB address is 10. See '*Remote interfaces*' for more details.

④ USB

The USB device port accepts a standard USB cable. The Windows plug-and-play functions should automatically recognise that the instrument has been connected. See '*Remote interfaces*' for more details.

⑤ K Lock

The Kensington slot is a standard slot that can be paired with a security cable lock.

⑥ LAN

The LAN interface is designed to meet 1.5 LXI (LAN extensions for Instrumentation) Core 2016. Remote control using the LAN interface is possible using a TCP/IP Socket protocol. See '*Remote interfaces*' for more details.

⑦ Chassis earth M4

The M4 threaded screw marked provides a connection point to safety earth ground. An M4 Ring tab must be used, with an appropriate washer.

⑧ Digital I/O [DIO]

The DIO is an input/output port that receives, and outputs signals through digital I/O lines. See '*Digital I/O*' for more details.

+5.25Vpk Max. (diode clamped to +5V). The 5V supply is internally fused (resettable fuse) to 500mA, see the SMU4000 Series Service Manual for more information.

5. INTRODUCTION

Using this Manual

This manual is a general introduction to the organisation of the instrument and is intended to be read before using the instrument for the first time.

In this manual:

- Front panel keys and sockets are shown in capitals, e.g., HOME, CNFG;
- Text, entry fields and messages displayed on the LCD are shown in a different font, e.g., **Source, Limit, Results**.
- Hyperlinks are shown in italics, e.g., '*Using this Manual*'

The descriptions in this manual relate to using the instrument via the touch screen, alternatively; the hard keys and rotary knob can be used. See *Navigation Controls* for details on how to use the rotary knob to control the instrument.

Throughout this manual, the navigation through menus will be shown at the top of a section using the following format: MENU>**Sub Menu**>**Option**

Other Manuals are available to download for this product series including:

- Safety Documentation and Quick Start Guide [English, French, German, Italian & Spanish]
- Programming Manual [English]
- Service Guide [English] available on request.

Available from www.aimtti.com/support.

Navigation Controls

Hard Keys

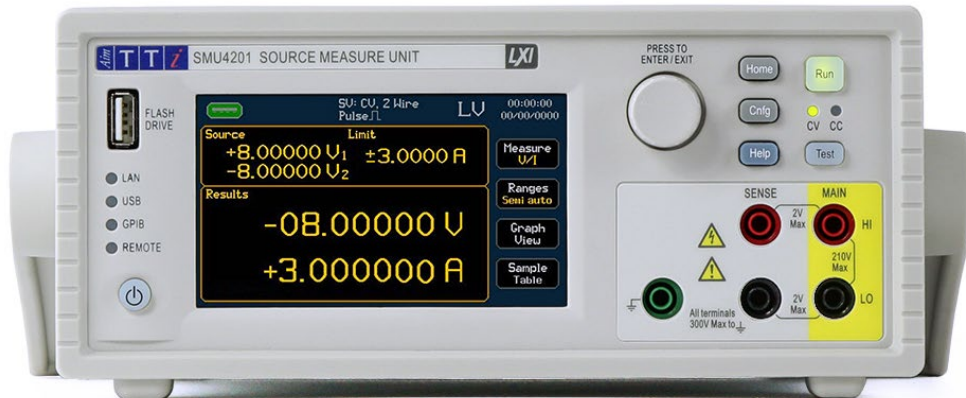

There are two main menus: HOME and CNFG (configuration)- These are accessed using the hard keys on the front panel. The items within these menus can be selected using the following options:

- **Touch Screen**
Direct selection and entry using touch. Simply touch the item with your finger to select.
- **Rotary Knob**
Turn the knob clockwise to initiate, once the desired button has been selected, press to engage the button. The knob can also be used to modify home screen parameters once they have been selected.

Menu Scrolling

Some menus contain more than one page of options, when this is the case, arrows ① are available to scroll the page up or down.

OK / Cancel

The OK and Cancel ② keys are available on all screens where changes can be made; pressing OK will apply any changes and return the previous menu., Cancel will return to the previous screen without making any changes.

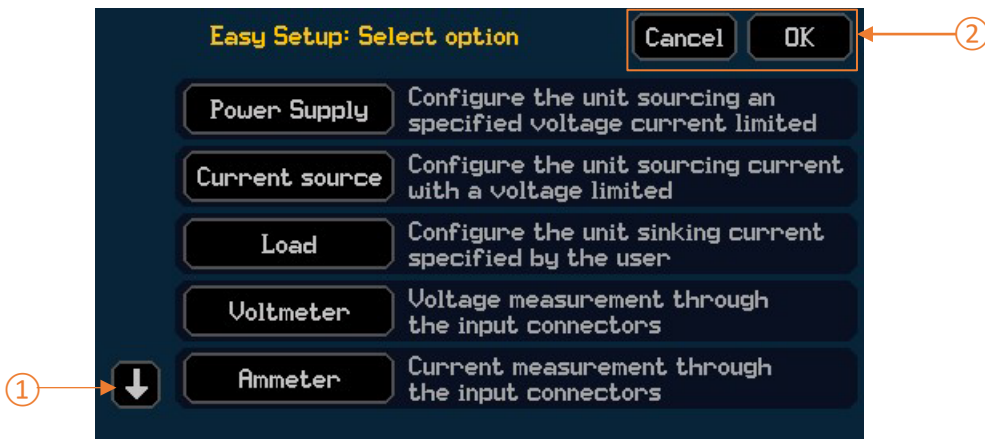

Back Button

The Back button is available on sub menus, when pressed it will return to the previous menu.

5 - Introduction

Navigation Controls

Numeric Keypad / Keyboard Pop-up

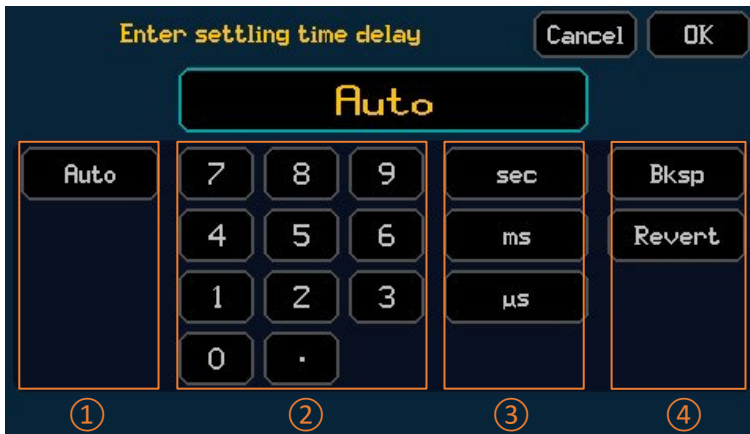

Depending on where the keypad pop-up appears, the following options will be available to select from on the keypad.

① Non-numeric Options:

Auto / Disabled etc.

② Numeric Selection

Numeric selection is 0-9, decimal point and minus sign (if negative values can be entered)

③ Unit Selection

④ Actions:

Bksp- Remove the previous number.

Revert- Revert the value back to the original; before the value was amended with the keypad.

Rev Pol- Available when a positive or negative value is to be accepted, toggles between plus and minus symbol.



A full QWERTY keyboard is available for text entry.

5 - Introduction

Home screen

Home screen

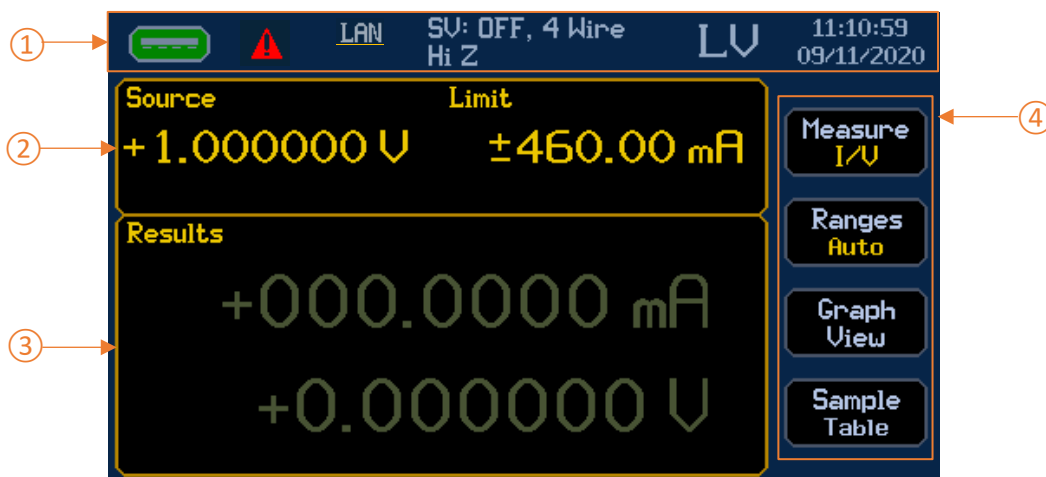

① Status bar

- USB flash drive status (connected/disconnected) and touch to capture screen image, if connected.
- Logged Event; a Warning, Caution or Information pop up has occurred and been logged. Touch to see the Event Log.
- LAN Status. Touch to edit in the Interfaces menu.
- Present Mode and selected shape (if other than steady), Output status, terminal configuration and selected OFF state. See '*Icons*' for more details. Touch to edit in the Manual Setup menu.
- Operating voltage limit [SMU4201 only]. LV (low voltage mode) for up to $\pm 42\text{V}$ working mode, HV (high voltage mode) for up to $\pm 210\text{V}$ working mode. Touch to change between LV and HV. By default, the unit is locked into LV mode and password protected, see '*Password protection*' for more details.
- Date and time, touch to edit, see '*Date and Time*' for more details.

② Source and Limits

User defined source/sink level and imposed limits, depending upon the selected mode. Values can be modified by direct touch keypad entry, simply press on the relevant parameter to bring up the numeric entry screen. Alternatively, the selected values can be modified by using the rotary knob.

③ Results

Results box contains the real time measurements and, if enabled, the measurement reference and math formula applied to the readings. When in Sequence mode the active step and operating mode will be shown.

④ Buttons:

See '*Measurement selection*', '*Selecting a Range*', '*Graph view Menu*' or '*Sample table*' for more information.

5 - Introduction

Home screen

Icons/ indicators on the status bar

The following icons or indicators may appear on the status bar.



Icon	Variations	Description	
① USB Flash Drive		Not Connected	
		Reading	
		USB Connected, Press to capture screen image	
		USB not supported.	
③ Event log		Event logged, Press to see logged event/s	
② LAN status	LAN	LAN detected	
	↑↓	Data Transfer detected	
	LAN IP Error	LAN IP Address Error	
④ Setup Status	Press to edit the setup.		
	Active Mode	SV	Source Voltage
		SC	Source Current
		LC	Load Current
		LR	Load Resistance
		LP	Load Power
		MV	Measure Voltage
		MC	Measure Current
		MR	Measure Resistance- Voltage Limited
		MHR	Measure Resistance- Current Limited
	SEQ	Sequence Mode	
	Note: If Sequence Mode is running it will show the Active Mode in the step.		
	Output status	OFF	Output Off
		ON	Output On
		CC	Output On- Constant Current
		CV	Output On- Constant Voltage
		CMV	Output On- Constant Maximum Voltage
	Terminal configuration	2 Wire	Main terminals- Source and Sense
		2W+Guard	Main terminals- Source and Sense. HI Sense terminal- Guard
		4 Wire	Main terminals- Source and Sense. Sense Terminals- Sense
	Off State (Output Off)	0V/100µA	Source 0V/ 100uA current limit
		Hi Z	Terminals are high impedance
		Zero	Source 0V
		Open	Terminals are open circuit
Shape (Output On, in place of Off State)	Steady	Source is steady	
	Pulse	Source is pulsed between two levels	
	Sweep	Source is swept in steps between start and end levels	
	List	Source is defined by a custom list of levels	
	Pulsed sweep	Source is swept in pulsed steps between start and end levels.	
⑤ Operating Voltage Limit *	Press to activate/deactivate the High Voltage Interlock. Note: To access the High Voltage Interlock, the password protection may need to be removed first.		
	*SMU4201 only.	LV	Low Voltage Mode
		HV	High Voltage Mode.
⑥ Time and Date	Press to edit Time and Date		

6. GETTING STARTED

Connections

Connections can be made to the front or rear terminals on the instrument. The front and rear terminals are connected in parallel and must *never* be used simultaneously.

Front/Rear connections

Front and rear terminals are always active, there is no need to select between the two.

The terminals on the front panel are 4mm banana jack connectors, and the rear-panel contains a terminal block. The rear terminals offer additional Guard connections for screening, see '*Terminal selection*' for more details.

Front panel Main HI and LO terminals are permanently wired in parallel with the rear panel F +/- [Force] terminals.

Front panel SENSE HI and LO terminals are permanently wired in parallel with the rear panel S +/- [Sense] terminals

WARNING



Only ever use either the front or rear terminals, never use both at once. Hazardous voltages will appear on both sets of terminals.

Hazardous voltages will appear on both sets of terminals.

Always make connections to the instrument with the OUTPUT off and in the Open off state; this is the only output state that completely isolates the external circuitry from the instrument.

6 - Getting Started

High Voltage Interlock [SMU4201 only]

High Voltage Interlock [SMU4201 only]

The instrument contains a high voltage interlock to prevent accidental access to potentially dangerous high voltages.

By default, the instrument is set to Low Voltage operation, restricting the maximum permitted voltage to $\pm 42\text{V DC}$. Source level and limit settings are restricted to a maximum of $\pm 42\text{V DC}$. If for whatever reason this voltage limit is exceeded whilst the output is running, the output will either continue to run and limit the voltage to the maximum of $\pm 42\text{V DC}$ (**Limited**), or the output will trip to the OPEN off state condition (**Trip**). This feature can be set in the Interlock Behaviour menu:

CNFG > [System] Manage > [Security] Interlock Behaviour.

The status of the interlock is shown in the form of a HV/LV icon on the status bar of the user interface home screen and can also be queried remotely.

There are three ways in which the interlock state can be changed between Low voltage operation and full voltage operation:

1. **Password Protection:** A password entry is required to enable full voltage operation. See '*Password protection*'. Once the password is entered correctly the interlock status can be changed by touching the LV symbol on the status bar of the home screen.
2. **External DIO control:** This allows for the controlling of the interlock via external circuitry. This is primarily designed for helping to ensure the safe operation and safety of users of the equipment when embedded into a test system or test fixture. For safety reasons, test fixtures that may contain hazardous voltages often utilize a safety cover, a form of lid or even complete doors to protect the user from hazardous voltage exposure. Installing a switch on any of these and linking to the external DIO interlock control allows for the limiting of hazardous voltages (Low voltage operation) whenever the switch is opened. For more information on the DIO interlock control see '*Digital I/O*'.
3. **Remote interface control:** The state of the interlock can be controlled directly without password protection. The status of the interlock can also be queried remotely. See the SMU4000 Series Programming Manual for more information.

WARNING



Enabling full voltage operation (asserting the interlock) could expose the user to potentially hazardous voltages that could result in injury or death.

Potentially hazardous voltages of up to $\pm 210\text{ V}$ may be present at the MAIN HI, F+/-, Sense HI, S+/- and Guard terminals.

These terminals should be considered hazardous even if set to a non-hazardous voltage or current level.

NOTE



Whenever the interlock setting is changed via the front panel or remote command, the output is disabled for safety purposes.

6 - Getting Started

Basic operation

Basic operation

Sourcing voltage and recording measurements

When set to default settings, the source voltage configuration settings will be loaded. To set the source level:

- Touch the source setting.
- Enter the required value and press OK.

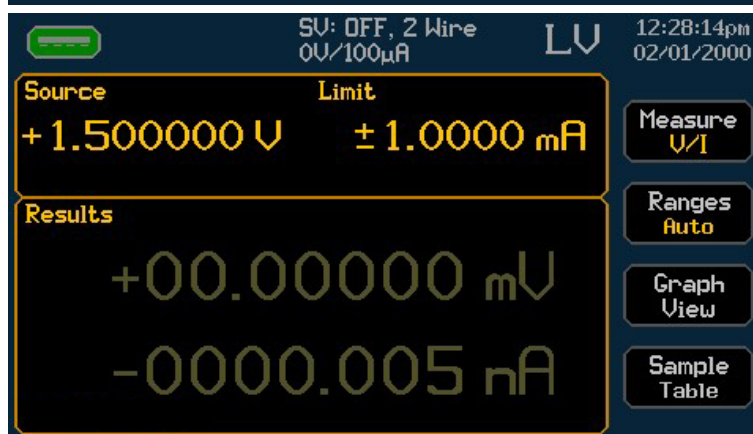
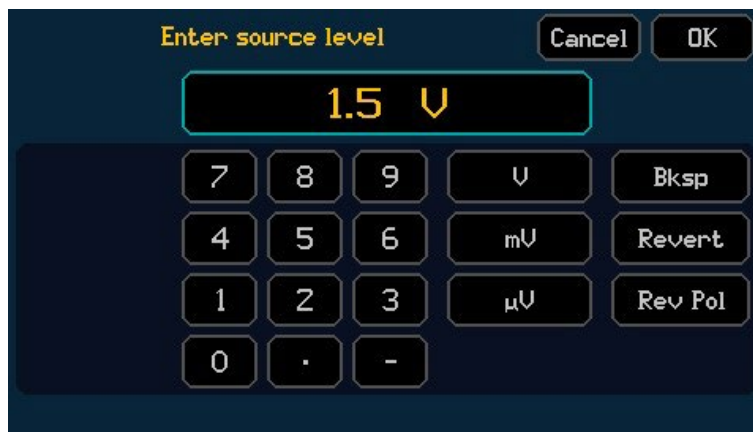

- Press the RUN hard key to activate the output.

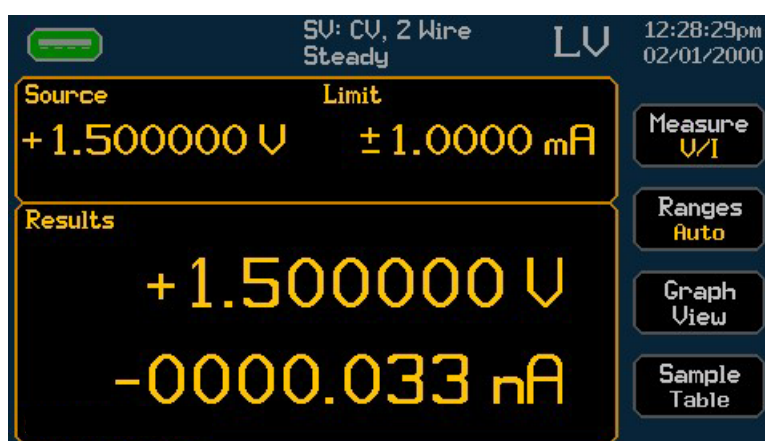

The default measurement count is infinite; therefore, measurements will be recorded up to the maximum amount of 100,000. Once reached, the output will remain on but measurements will no longer be recorded.

The default measurement period is 1 PLC. One Power Line Cycle (PLC) for 50Hz is 20ms and one PLC for 60Hz is 16.67ms. Mains input frequency is automatically monitored and applied by the instrument.

6 - Getting Started

Basic operation

Live adjusting source and limits from the home screen

The source and limit parameters can be adjusted in real time using the rotary knob when the output is active. To adjust the source level in real time:

- Press the RUN hard key to activate the output.
- Highlight the source value using the rotary knob.

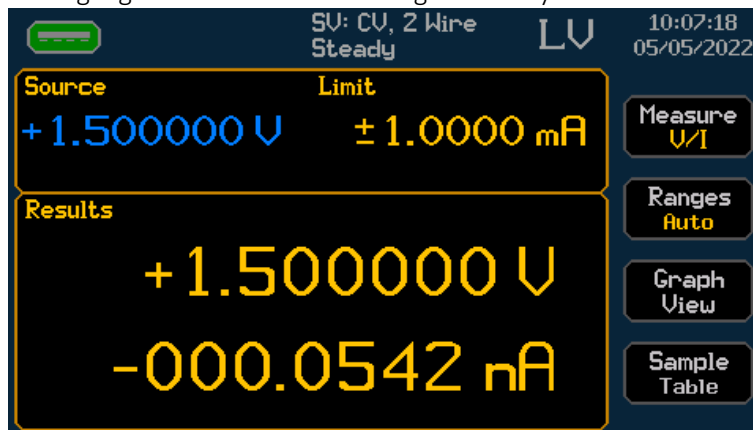

- Press the knob to enter the editing state, the knob will now scroll through the source values.

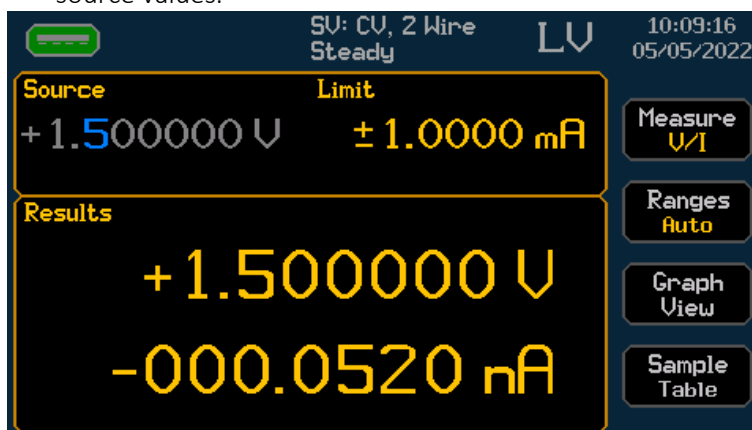

- Scrolling left and right will change the value resolution. Press again to edit the numeric value.

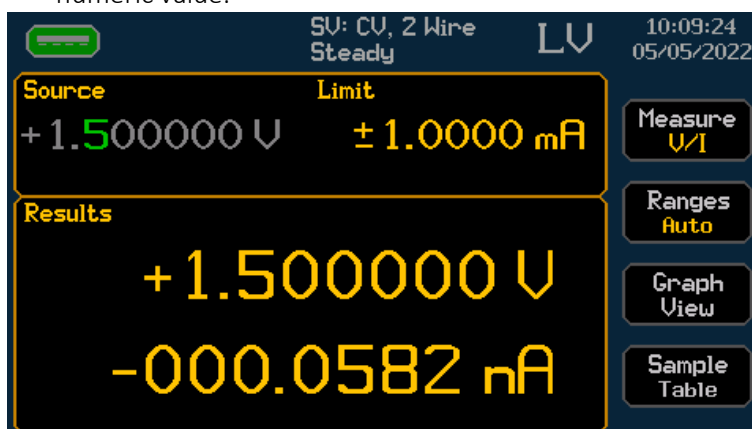

NOTE



A green digit indicates the encoder is in an active state, any adjustments using the encoder are live and will be actioned at the terminals immediately (when the SMU is running).

- Double press the knob or press the HOME key to exit the live editing mode.

6 - Getting Started

Selecting a Range

Selecting a Range

HOME > Ranges

Before considering a range selection it is important to understand the concept of manual setup modes that are used in the SMU; see 'Operating Mode' for more details. Configuration settings, including the selected ranges, are linked to the selected mode of operation.



NOTE



Range selection is 'Manual setup' specific.

Ranges can be set for current and voltage, the available ranges are determined by the selected mode of operation.

A range can be set to **Auto**, or a manual value.

Most applications will require Auto Range, however if high accuracy or speed is required it may be necessary to select a manual range.

The automatic range selection determines and selects the most suitable ranges based upon the measured readings and source settings.

Timing considerations

Faster Response Speeds

Selecting a manual range can assist with faster response speed. Auto ranging changes the range whilst the output is running, this can lead to increased rise/measurement/settling times whilst the instrument selects the appropriate range; selecting a manual range overcomes this potential timing penalty.

NOTE



The fastest response speeds can only be achieved when a manual range is selected.

Reduced settling times

Settling times can be reduced when in auto range by selecting a minimum range value. This defines the minimum range that the instrument can select during auto-ranging. Setting this to the lowest range that is required for the given test/application may help to reduce the settling time, as the lower ranges have generally longer settling times.

6 - Getting Started

Selecting a Range

In order to bypass this functionality, simply set the minimum range to the smallest range available.

To set the minimum range, press the **Auto (Min.Range xxx)** Button. Set the minimum required range and press **Back** to return to the Range Menu.



Stability Considerations

Auto ranging can, in some specific cases (where there may be a significantly highly reactive load) lead to potential instability or oscillations. If this occurs, selecting the appropriate manual ranges can alleviate the issue. When using the most sensitive current ranges i.e. 200nA and 2 μ A ranges potentially instability could occur, in this case try a higher current range.

Limit considerations

NOTE



The source and limit level settings cannot exceed 105% of the selected associated range. The limit setting is restricted to a minimum of 10% of the manually selected range.

If a lower manual range is selected that causes the existing source or limit level setting to exceed the selected range maximum, the associated level is set to 105% of the new range. Likewise, if a higher manual range is selected that causes the existing limit level setting to exceed the selected range maximum, the limit level is set to 10% of the new range.

NOTE



In SC and MR modes (see 'Operating Mode' for more details) where the current source is utilized, the 3A range can only be accessed via manual range selection, the auto current range will stop at the 1A range.

Noise pickup, leakage and instability issues may arise when testing within certain manual ranges, see 'Application notes' for tips to overcome these issues.

6 - Getting Started

Measurement selection

Measurement selection

HOME > Measure



The measurement selection configures the primary and secondary measurements. The primary and secondary measurements can be set to measured voltage, measured current or the computed power or resistance.

Only the selected primary and secondary measurements appear on the home screen results section, within the sample table measurement buffer and within the measurement statistics menu.

The primary measurement is used for setting the live and custom measurement reference math operations (See '*Math*'), and defining the measurement that is displayed on the YT graphical view (See '*Graph*').

NOTE



The exported .CSV files contain all four measurement types.

NOTE



Alternative primary and secondary measurement types can be selected after the test is complete. The selected measurement data can be viewed in the sample table or the YT graph (primary measurements).

6 - Getting Started

Saving Data

Saving Data

CNFG > [Files] Data Store

The buffer records all the information displayed in the sample table. Up to 100,000 points can be recorded at any time.

NOTE



The buffer data is cleared each time the output is run, ready for the next set of measurement data to be collected. The buffer data is also automatically cleared when the instrument is power cycled.

Buffered data can be saved as a .CSV file to a USB flash drive connected via the front panel, either manually or automatically.

The .CSV file will contain the following information:

- Index
- Active Mode
- Output state
- Measurement results (V and A)
- Calculated results (R and W)
- System Date
- System Time
- Measurement Timestamp
- Sequence Mode Step and Iteration

Index	Step	Iteration	Date	System Time	Format	Measured Mode	M1	Units	M2	Units	M3	Units	M4	Units	CV	CC	PTol	STol
1	0	0	#####	11:22:38 AM		0.00E+00 SV	8.00E-08	Volts	-3.00E-11	Amps	-2.40E-18	Watts	-2.67E+03	Ohms	ON	OFF	N/A	N/A
2	0	0	#####	11:22:38 AM		2.00E-02 SV	2.00E-08	Volts	-2.10E-11	Amps	-4.20E-19	Watts	-9.52E+02	Ohms	ON	OFF	N/A	N/A
3	0	0	#####	11:22:38 AM		3.99E-02 SV	6.00E-08	Volts	-2.45E-11	Amps	-1.47E-18	Watts	-2.45E+03	Ohms	ON	OFF	N/A	N/A
4	0	0	#####	11:22:38 AM		5.99E-02 SV	1.00E-08	Volts	-2.13E-11	Amps	-2.13E-19	Watts	-4.69E+02	Ohms	ON	OFF	N/A	N/A
5	0	0	#####	11:22:38 AM		7.99E-02 SV	2.00E-08	Volts	-2.73E-11	Amps	-5.46E-19	Watts	-7.33E+02	Ohms	ON	OFF	N/A	N/A
6	0	0	#####	11:22:38 AM		9.98E-02 SV	-1.40E-07	Volts	-2.72E-11	Amps	3.81E-18	Watts	5.15E+03	Ohms	ON	OFF	N/A	N/A
7	0	0	#####	11:22:38 AM		1.20E-01 SV	2.20E-07	Volts	-3.21E-11	Amps	-7.06E-18	Watts	-6.85E+03	Ohms	ON	OFF	N/A	N/A
8	0	0	#####	11:22:38 AM		1.40E-01 SV	-1.20E-07	Volts	-3.80E-11	Amps	4.56E-18	Watts	3.16E+03	Ohms	ON	OFF	N/A	N/A
9	0	0	#####	11:22:38 AM		1.60E-01 SV	8.00E-08	Volts	-3.70E-11	Amps	-2.96E-18	Watts	-2.16E+03	Ohms	ON	OFF	N/A	N/A

NOTE



To store all measurement data, the measurement buffer should be exported over remote or to an external flash drive after completion of each run (automatically).

6 - Getting Started

Saving Data



Save Data Automatically

To automatically save the data to USB after every run, press the **Auto Store** function. The file name will be highlighted with a green border and the data will be saved to the flash drive when the SMU has completed a run.

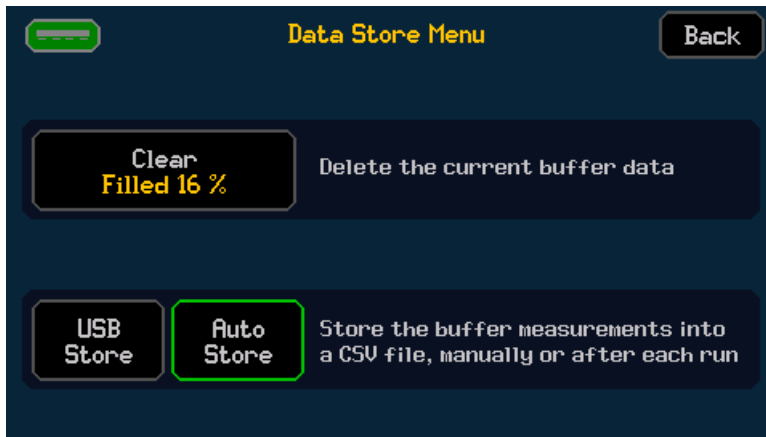

Save Data Manually

To manually save data, press the **USB Store** button. A .CSV file will be saved to the USB Flash drive each time the **USB Store** button is pressed.

Buffer status

The buffer status is displayed as a percentage within the **Clear** button, when pressed the data will be cleared and set to 0%.

View buffer data

Buffered Data can be viewed in three different formats from the front panel:

- Individually indexed measurements, see '*Sample table*' for more details.
- Graphically plotted data, see '*Graph*' for more details.
- Statistically, see '*Measure Statistics*' for more details.

6 - Getting Started

Sample table

Sample table

CNFG > [Files] Sample Table

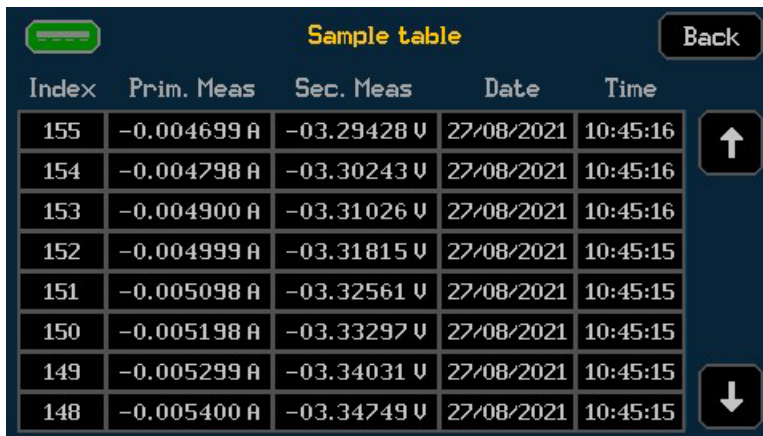

Index	Prim. Meas	Sec. Meas	Date	Time
155	-0.004699 A	-03.29428 V	27/08/2021	10:45:16
154	-0.004798 A	-03.30243 V	27/08/2021	10:45:16
153	-0.004900 A	-03.31026 V	27/08/2021	10:45:16
152	-0.004999 A	-03.31815 V	27/08/2021	10:45:15
151	-0.005098 A	-03.32561 V	27/08/2021	10:45:15
150	-0.005198 A	-03.33297 V	27/08/2021	10:45:15
149	-0.005299 A	-03.34031 V	27/08/2021	10:45:15
148	-0.005400 A	-03.34749 V	27/08/2021	10:45:15

The Sample Table displays the contents of the buffered measurement data in a table format. The contents of the table include the index, primary measurement, secondary measurement, date, and time. Results are stored sequentially from the first index number and will be stored until the buffer limit is reached, at 100,000 measurements.

The time is recorded as HH:MM:SS.

The date is recorded as DD/MM/YYYY (Default), MM/DD/YYYY or YYYY/MM/DD, depending on the format selected, see 'Date and Time' for more details.

All exported data from the sample table to the .csv file will be formatted as YYYY/MM/DD.

The up and down arrow keys can be used to scroll through the results in the sample table. Using the touch screen, pressing, and holding the button will scroll through the results faster.

A single result can be selected and used as a reference point for a math function. To set the reference point, use the encoder to select the required primary measurement and press to activate. See 'Math' for more details.

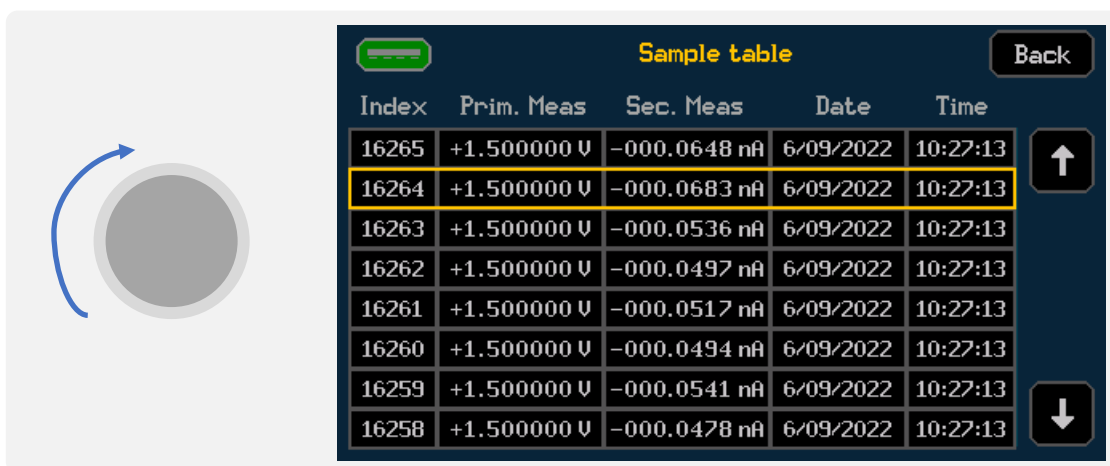

Index	Prim. Meas	Sec. Meas	Date	Time
16265	+1.500000 V	-000.0648 nA	6/09/2022	10:27:13
16264	+1.500000 V	-000.0683 nA	6/09/2022	10:27:13
16263	+1.500000 V	-000.0536 nA	6/09/2022	10:27:13
16262	+1.500000 V	-000.0497 nA	6/09/2022	10:27:13
16261	+1.500000 V	-000.0517 nA	6/09/2022	10:27:13
16260	+1.500000 V	-000.0494 nA	6/09/2022	10:27:13
16259	+1.500000 V	-000.0541 nA	6/09/2022	10:27:13
16258	+1.500000 V	-000.0478 nA	6/09/2022	10:27:13

NOTE



The sample table will only display the primary and secondary measurement data; however, the internal buffer contains all four measurements which can be exported or can be accessed via changing the primary and secondary measurements. Changing the primary and secondary measurements can be done live or even after the test is complete to access all four measurement data sets.

6 - Getting Started

Measurement Statistics

Measurement Statistics

CNFG > [Files] Measure Statistics

The measurement statistics menu provides statistical measurement information based upon the primary and secondary measurement data. With a large 100k measurement buffer it can be very difficult to pick out key information from the sample table alone. The measurement statistics menu provides details of:

- Minimum sample value
- Maximum sample value
- Total measurement span (min to max)
- Average (mean)
- Standard deviation of the measurements for both the primary and secondary measurements.

The measurement statistical data is based on the data that is in the sample table and is updated accordingly, as new data is recorded.

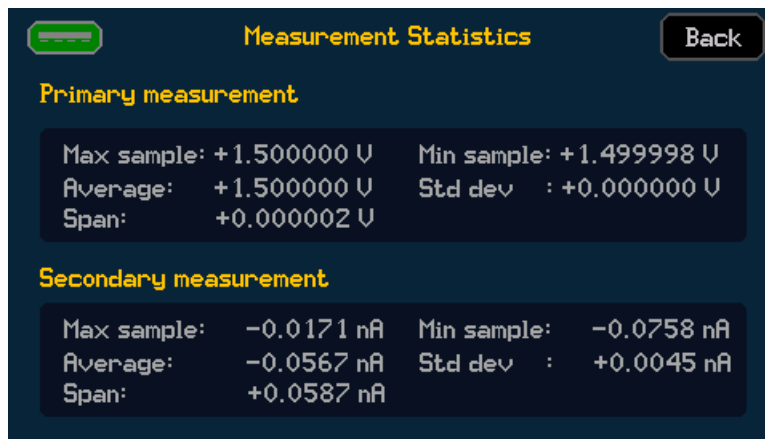

NOTE



Changes to the primary and secondary measurements can be actioned live or even after the test is complete to access all four sets of measurement statical data (V, I, W & Ω).

6 - Getting Started

Graph

Graph



The Graph provides a graphical representation of the buffered results. This may be real time data or previous test data already stored in the buffer. The real time / buffered data is always shown in yellow. Any saved 'Trace' data is shown in blue- see 'Trace' for more details.

There are two separate graphing menus; graphing options with full manual control that is accessed from the Configuration (CNFG) menu, and a view of the graph that is accessed from the home screen.

NOTE

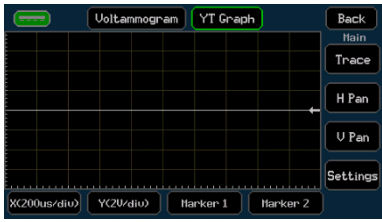

The two graph menus are linked; changes made in the **Graph** menu will be reflected in **Graph view** and vice-versa.

	Graph	Graph View
Feature	 <p>(Blue background) CNFG > [Files] Graph</p>	 <p>(Black Background) HOME > Graph View</p>
Auto-Scale	•	
Auto-Fit		•
Graph Type	•	•
Graph Style	•	•
Minimum Position	•	•
Markers	•	•
Save/Load Trace	•	•
Panning	•	
Zooming	•	

6 - Getting Started

Graph Menu

Graph Menu

The graph uses an Auto-Scaling function to best fit the data onto the graph, the difference between the Auto-Scaling and the Auto-Fit of the Graph View is that the Auto-Scaling is designed like a traditional oscilloscope with standard 1,2,5 scaling applied to the X and Y axis. Auto-Scaling also applies no offset compensation.

Auto-Scaling is activated by pressing a Graph Type button ①

Graph Type

Measurement data can be displayed in two formats, as two different graph types:

YT Graph (Default): The primary measurement data is plotted against time on the X axis.

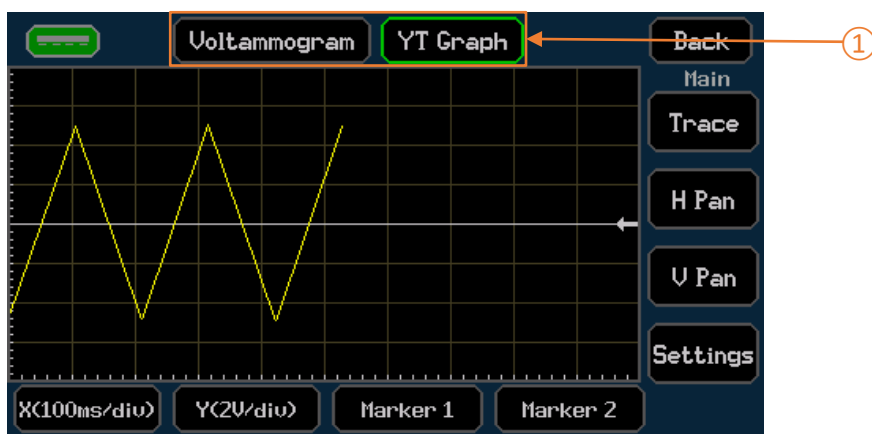

Voltammogram (I/V Scatter): A plot of voltage against current. This graph type is ideal for I/V curve tracing.

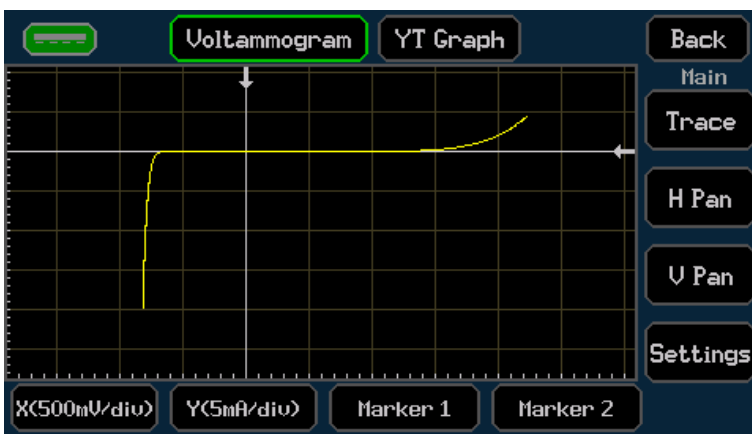

Select the graph type using the **Voltammogram** and **YT Graph** buttons positioned above the graph display.

NOTE



Pressing either the **Voltammogram** or **YT Graph** buttons will cause the graph to auto-scale; any manual scaling changes will be lost.

6 - Getting Started

Graph Menu

Graph Settings

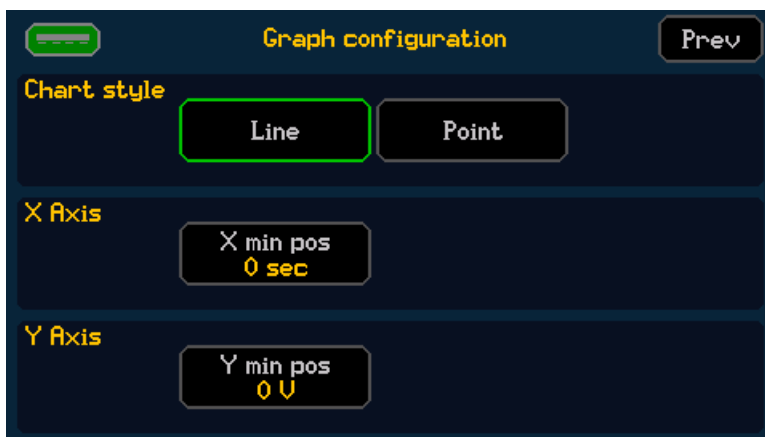

The following settings are available by pressing the Settings button:

Graph Style

Line (Default): Show the measured points connected in a linear format with a single line.

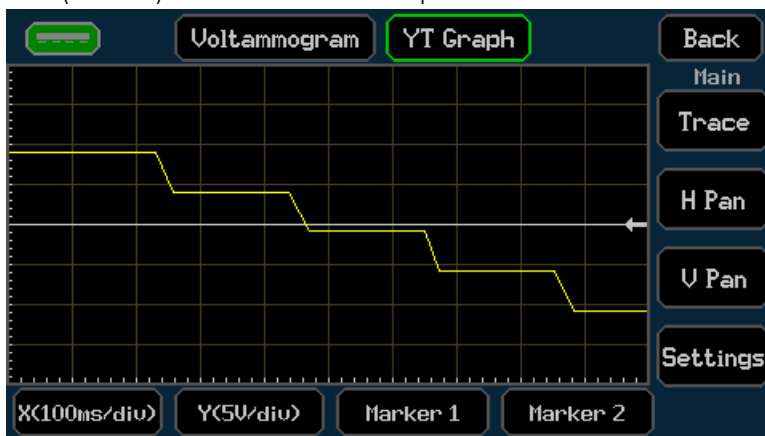

Point: Show each measured point on the graph as a single pixel.

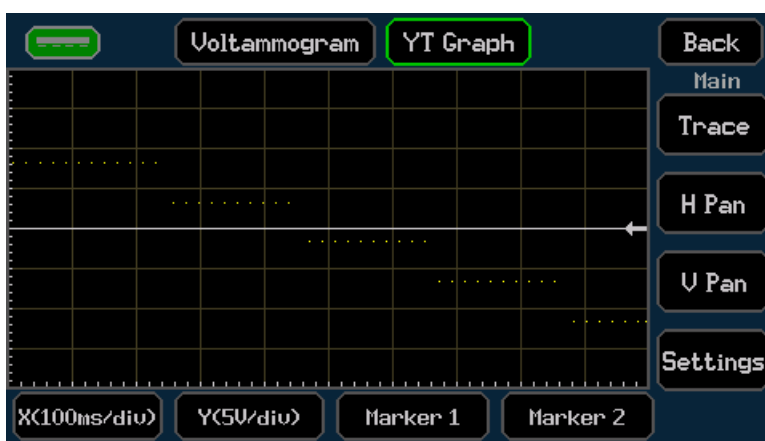

Minimum position

A minimum X and Y position can be defined, starting the plotted results at a defined point.

6 - Getting Started

Graph Menu

Markers

Markers are based on the display position and are not linked to measurement data points. Marker selection is a multi-stage process:

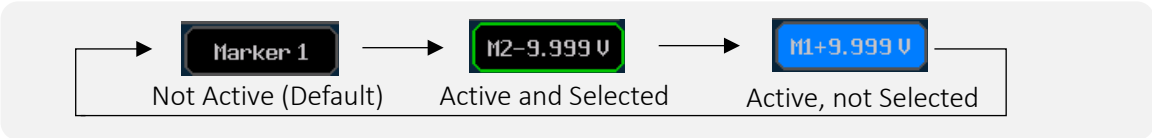

To enable the markers, select the **Marker 1** or **Marker 2** button located at the bottom of the graph.

Upon the first press the marker will appear as a red line across the span of the graph and a green outline will appear to show the marker can now be moved, use the encoder to move the marker.

The Marker Button shows the marker value, which is shown to a resolution of up to four digits, to see the full resolution of the marker reference point, use the **Stats** button.

Once a marker has been selected, the markers menu **①** will be active.

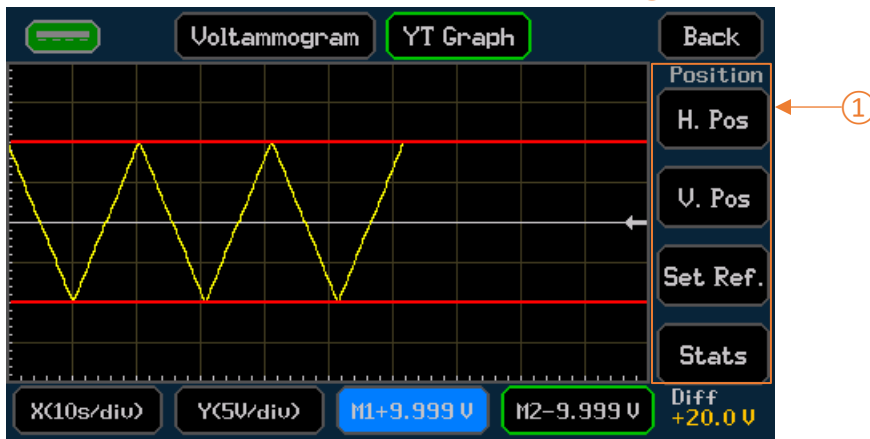

Marker orientation can be set to horizontal using the **H.pos** button or vertical using the **V.pos** button. When both X and Y markers are set to the same orientation, the difference between the two is displayed in the bottom right-hand corner of the display in the marker's menu. To see the full resolution, use the **Stats** button.

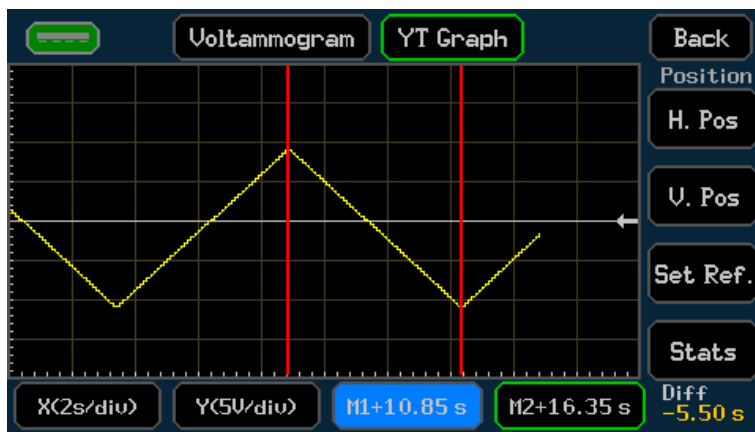

A reference point based on the selected marker (used in the math function) can be set directly from the graph using the **Set Ref** button. See *'Math'* for more details.

Pressing the Marker button whilst the marker is active will disable the movement of the marker via the encoder; however, the marker value and marker menu will still be displayed. This allows for selection switching between the two markers, only one marker position can be adjusted at any given time.

6 - Getting Started

Graph Menu

A final consecutive press of the marker button disables the marker completely, the marker menu will still be displayed if the either marker is still active.

Trace

The trace functionality enables a reference trace to be stored and recalled, allowing for a previously stored trace to be compared against the latest measurement trace. Data in the buffer will be displayed in yellow, the trace will be blue.

Once Trace has been selected, the trace menu ① will be active.

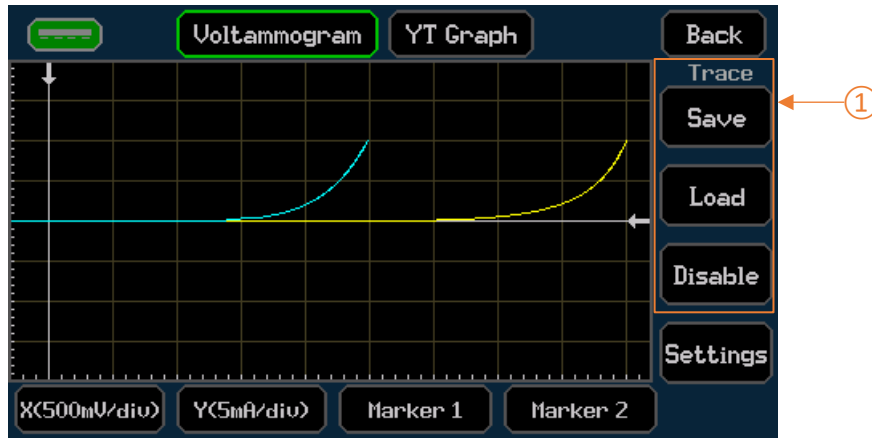

NOTE



This can be very useful when comparing two DUTs (device under test) to see the difference in performance between the two. One reference trace can be stored at any given time.

The trace menu gives the following options –

Save – Store the existing latest measurement graphical waveform as the reference trace.

Load – Recall and display the previously saved reference trace.

Disable – Stop viewing the loaded reference trace.

The loaded reference trace appears in blue on the same graph as the latest measurement trace.

NOTE



When recalling a trace, the graph auto-scale will ensure both the recalled trace and the latest measurement trace are visible on the display regardless of difference in levels.

6 - Getting Started

Graph Menu

X & Y Axis Scaling

The X and Y Axis scale can be altered to effectively 'zoom' in or out of the displayed data on the graph – this method will force the scaling into manual mode.

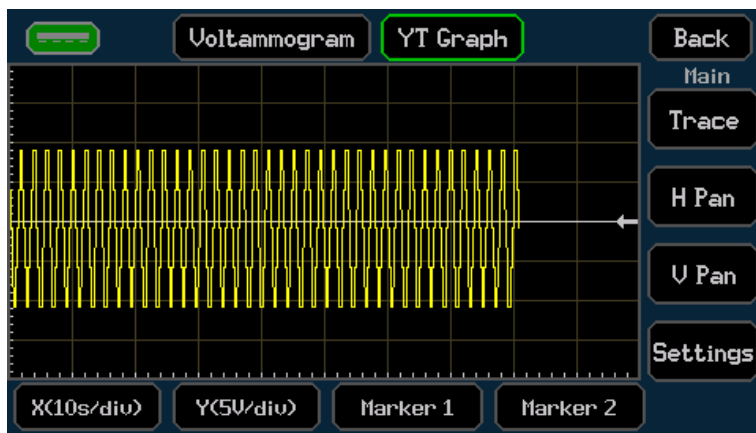

To change the scale, select the X (xxx/div) or Y (xxx/div) button located at the bottom of the graph. The X and Y axis will remain in the automatically selected ranges until modified. A green outline will appear to show the range can now be changed, use the encoder to change the range, the scale will then be adjusted using units per division.

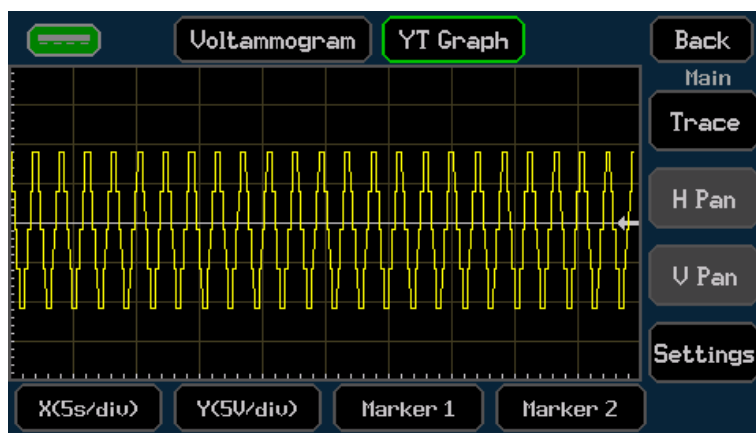

Press the button again to disable the movement via encoder and return to navigation.

NOTE



To familiarise a new user with the graph navigation; using the Auto-Scale (Type button) to define the best suited ranges for the data, then using the manual scale to 'zoom' in and out on specific areas of the measurement data by increasing and decreasing the scale as needed.

Panning

Panning can be set to horizontal using the H.Pan button or vertical using the V.Pan button located in the Main menu section of the graph, this function will force the scaling into manual mode. Once selected a green outline will appear to show that the graph can now be moved either vertically or horizontally (dependant on selection). Use the encoder to pan the graph. Press the button again to disable the movement via encoder and return to navigation.

6 - Getting Started

Graph view Menu

Graph view Menu

HOME > Graph View

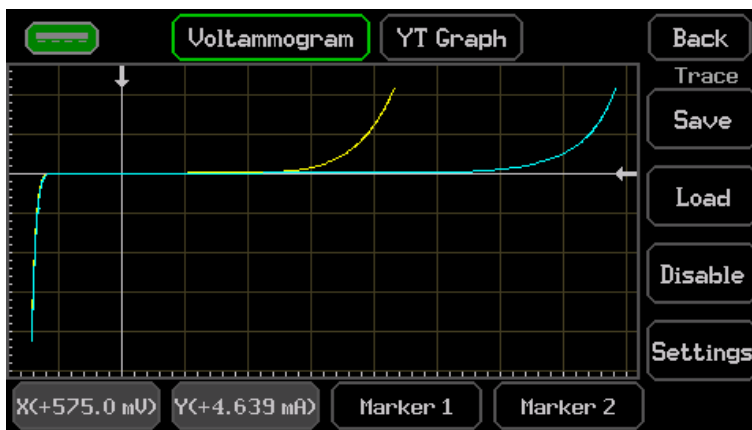

Graph View uses Auto-fit scaling- displaying the results in an automatically scaled view to best fit the display; all the results will be shown at once. Graph view utilizes no standard range scaling, the scaling is entirely arbitrary, allowing the results to fill the graphical area. The auto-fit scaling also deals with any offsets within the measurement data, offsetting the graphical view accordingly. This provides an instant graphical view of all the buffered measurement data, scaled to fit perfectly within the graphical window area. The Graph View menu has a darker (black) background than the Graph menu, to assist with recognition.

NOTE



Scaling or panning functions are not available in Graph View.

Although scaling or panning options are not available, one method that can be implemented for focusing in on an area of interest can be to re-run a specific test within the window of interest. Graph view allows for the quick and easy view of the full measurement buffer data, which means that a specific area of interest is very easy to find, especially with the use of the markers.

As an example, re-running an I/V trace curve sweep of a DUT around the area of interest can be potentially quicker and provide greater measurement resolution than trying to pan and zoom into a specific area of a graph under manual control.

The Graph View menu allows the use of **Markers** and the reference **Trace** function to view, assess, and compare the results. The graph type can be set to **YT Graph** or **Voltammogram**, and graph style to **Point** or **Line** see '*Graph Menu*' for more details on these functions.

NOTE



When a USB Flash Drive is present, screen captures of the graph can be stored by pressing the flash Drive symbol in the top left corner.

6 - Getting Started

Storing and Loading Setup Files

Storing and Loading Setup Files

CNFG > [Source Measure Action] Store Setup

Setup Files are managed in the Store Setup menu, from here Setups can be:

- Stored to an Internal Memory.
- Recalled from the Internal Memory.
- Deleted from the Internal Memory.
- Exported to a USB Flash Drive.
- Imported from a USB Flash Drive.

Store a Setup to the Internal Memory

To store a Setup to the Internal Memory, select the item **Empty block** ① followed by **Store Internal** ②. A keyboard will appear on screen, type the required file name- up to 7 characters, and press OK.



The file type will vary depending on the set mode, there are two types of files that will be stored:

.STP – Manual Setup file type

.STP files contain all the set parameters from the Manual Setup when one of the following Manual Modes are selected: SV, SC, LC, LR, LP, MV, MC, MR, or MHR.

.STP files stored in the internal memory can be added to a Sequence. See 'Sequence mode' for more details.

.SEQ- Sequenced Setup file type

.SEQ files contain the contents of the sequence setup when 'Sequence' is the selected Manual Mode.

Up to 20 manual setup files and 20 sequenced setup files can be stored at one time between the internal memory and USB flash drive.

NOTE



The files stored on the Internal memory will take priority. If a USB flash drive is connected and internal max file limit is reached, no external files will be shown until an internal file is deleted.

6 - Getting Started

Storing and Loading Setup Files

Load a Setup from the Internal Memory

To recall a Setup from the Internal Memory, select the required setup ①, followed by Load ②. A pop-up box will appear to confirm the action.

NOTE



Recalling any stored setup will overwrite the existing configuration.

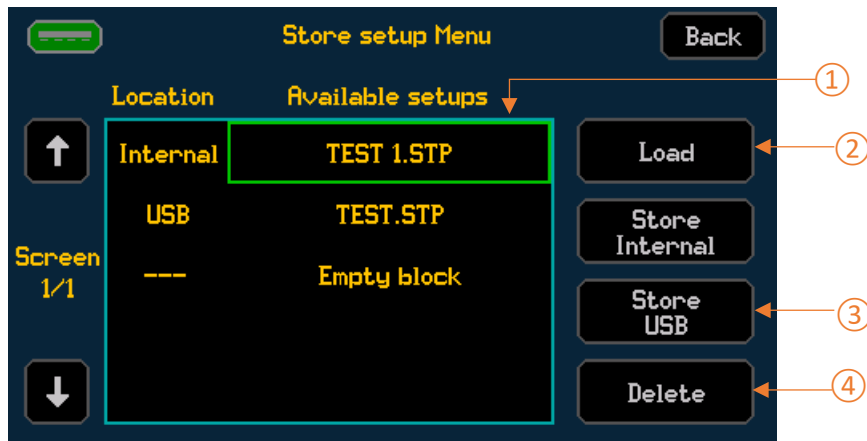

Delete a Setup from the Internal Memory

To delete a Setup from the Internal Memory, select the required setup ①, followed by Delete ④. A pop-up box will appear requesting to confirm the action.

Export a file to a USB Flash Drive

Once a setup has been stored as an internal file, it can be exported to a USB Flash Drive.

To export a file, select the file to be transferred ①, once selected the file name will be highlighted with a green border, press Store USB to export.

The file will appear in the available setups list, with USB as the location.

6 - Getting Started

Storing and Loading Setup Files

Import a file from a USB Flash Drive

USB files can be imported into the Internal Memory.

NOTE



Files must be imported into the Internal Memory before they can be loaded, external USB Files cannot be loaded or deleted using the store setup menu.

To import a file, select the file ① to be imported, once selected the file name will be surrounded with a green box, press **Store Internal** ② to import.

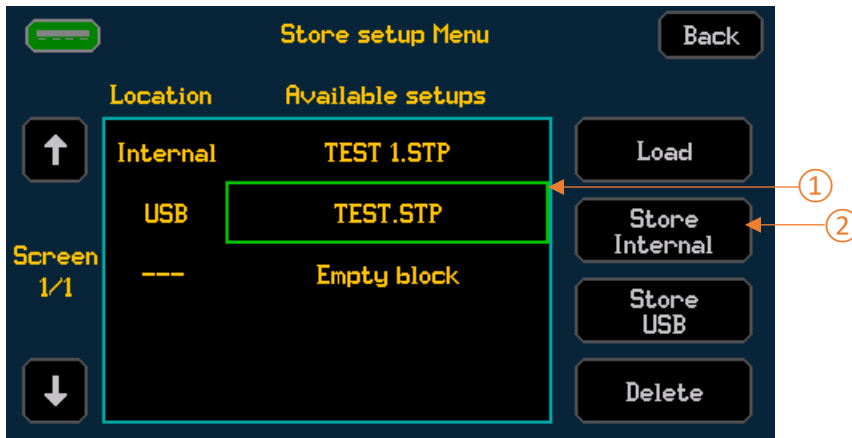

The file will appear in the available setups list, with **Internal** as the location.

File type- colour

File names may appear in the following colours:

- Yellow:** Compatible.
- White:** Incompatible with the current firmware version or model.
- Red:** Corrupted- Unable to be used or recovered.

To load an arbitrary list of set levels for a sweep (.CSV), see '*Loading a List*'.

To store buffer measurements (.CSV), see '*Saving Data*'.



6 - Getting Started

Event log

Event log

CNFG > [System] Event Log

The Event Log displays a record of events that have occurred whilst the instrument has been operational, these include warning, error, and information alerts.

  Whenever a new warning, error or information event occurs, a warning symbol appears on the status line of the home screen, this is often accompanied by a pop-up. Pop-ups are colour coded based on the type of event that has occurred.

The duration that the pop-up is displayed can be changed using the **Message Time** button; this can be set to a duration in seconds, or infinite. When set to infinite, touch the pop-up to remove it.

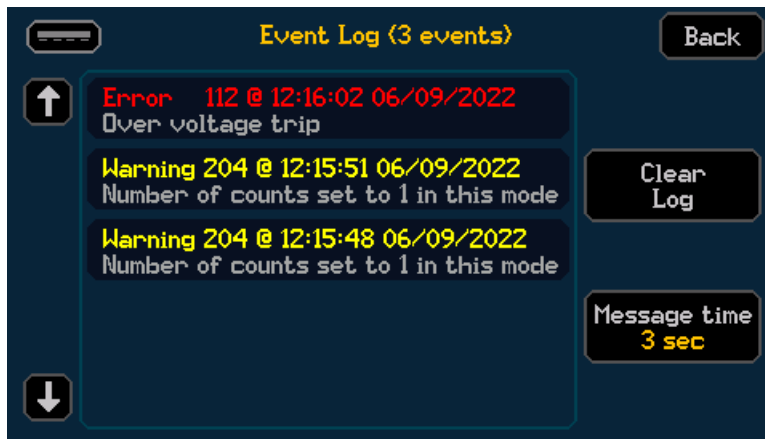

Selecting the Event Log symbol on the status bar will open the event log menu, this menu can also be accessed through the System menu: CNFG > [System] Event Log. Within the Event log menu, the events are colour coded and include a Warning or Error number alongside the time and date of when the error occurred.

7. EASY SETUP

Overview

CNFG > [Source Measure Action] Easy Setup

The Easy Setup menu contains a number of pre-configured setups, providing instant configuration for basic operational use of the SMU, these include:

- Power Supply
- Current Source
- Load
- Voltmeter
- Ammeter
- Ohmmeter
- IR Meter [Insulation Resistance Meter]
- LC Meter [Leakage Current Meter]

NOTE



Selecting any of the pre-configured 'Easy Setups' will reset the settings to the default for the related manual setup mode. However, if the manual setup is set to anything other than the mode related to the easy set, the settings will still be available when returning to that mode.

Easy setup	Manual Mode	Easy setup	Manual Mode
Power Supply	SV	Ammeter	MC
Current Source	SC	Ohmmeter	MR
Load	LC	LC Meter	SV
Voltsmeter	MV	IR Meter	MHR

See 'Factory Default settings' for more details.

Once an easy setup has been selected, further settings can be configured using the Manual Setup menu.

To activate a pre-configured setup, select the required option and press **OK**. If no option is selected, pressing **OK** will return to the Configuration menu and no change will be made.

For more details, see SMU4000 Series Safety Documentation and Quick Start Guide, available to download from: www.aimtti.com/support.

8. MANUAL SETUP

Overview

CNFG > [Source Measure Action] Manual Setup

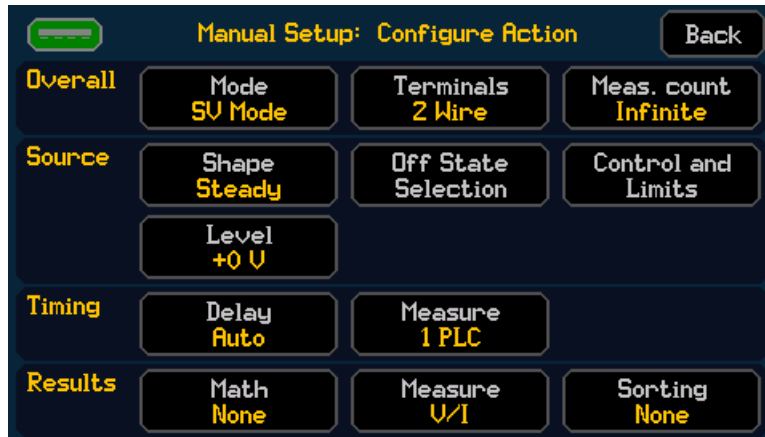

The Manual Setup menu contains options and settings for source and measurement configurations.

NOTE

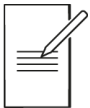

All options and settings in the Manual Setup menu are saved to the selected source and measurement mode, or 'Operating Mode'.

Manual Setup options and settings are as follows:

- 'Operating Mode' (Source / Load / Measurement/ Sequenced Mode)
- 'Terminal selection'
- 'Measurement count'
- 'Source shape'
- 'Output off state'
- 'Source Level'
- 'Limits and Protection'
- 'Timing options'
- 'Result sorting'
- 'Math Functions'

When the manual setup is complete, it can be stored in non-volatile memory or exported via a USB Flash Drive using the Store Setup menu, see 'Storing and Loading Setup' for more details.

8 - Manual setup

Operating Mode

Operating Mode

CNFG > [Source Measure Action] Manual Setup > [Overall] Mode

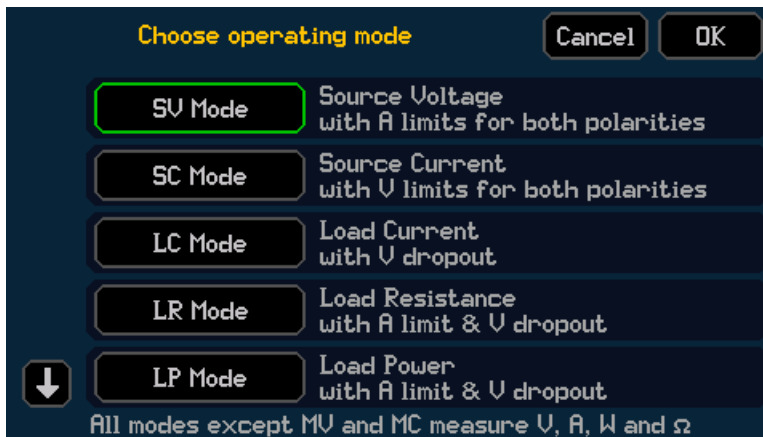

The Mode menu contains options for the source and measurement operating functionality.

NOTE



All options and settings in the Manual Setup menu are saved to the selected '*Operating Mode*'.

Operating Mode options are as follows:

- '*Source Voltage*' [Default]
- '*Source Current*'
- '*Load Current*'
- '*Load Resistance*'
- '*Load Power*'
- '*Measure Voltage*'
- '*Measure Current*'
- '*Measure Resistance and High Resistance*'
- '*Sequence mode*'

NOTE



Changing the mode whilst the instrument output is running will disable the output to the given Off State defined for that mode.

8 - Manual setup

Source Modes

Source Modes

Source Voltage (SV)

CNFG > [Source Measure Action] Manual Setup > [Overall] Mode > SV Mode

When set to source voltage, the SMU will perform as a low-impedance dual polarity voltage source with a single user defined current limit for both polarities.

Current, Voltage, Resistance and Power can be simultaneously measured whilst sourcing voltage. The sense circuit constantly monitors the output Voltage, and the in-built voltmeter measures the voltage and compares it to the configured value, adjusting where necessary.

NOTE



In SV mode, the SMU will sink current if a voltage is set below that of the external source.

For example, if a 5 V battery is connected as a voltage source (HI to battery +ve) and the SMU is set to source +4 V, in SV mode the SMU will sink current from the external battery (source +V and measure -I).

Source Current (SC)

CNFG > [Source Measure Action] Manual Setup > [Overall] Mode > SC Mode

When set to source current, the SMU will perform as a dual polarity current source with a single user defined voltage limit for both polarities. The current source can be used to source and sink a constant current.

Current, voltage, resistance and power can be simultaneously measured whilst sourcing current. The sourced current is constantly monitored and compared to the configured value, adjusting where necessary.

8 - Manual setup

Load Modes

Load Modes

The selected load mode determines how the current drawn by the SMU varies with the applied voltage.

When set to a load (or sink) mode, the power dissipating stage in the SMU is fundamentally an adjustable current sink, which conducts a current that does not depend on the voltage presently applied from the source being investigated. This is known as Constant Current operation.

The SMUs fast digital feedback loop is used to offer other operating modes in which the current does depend on the applied voltage in a known way, providing the additional choices of Constant Power and Constant Resistance characteristics.

The SMU load modes can only be used in one single quadrant, with positive external source voltages and negative load currents.

When sinking high currents, it is always recommended to use the 4-wire terminal configuration to sense the voltage directly at the external source terminals.

Dropout voltage

Resistive discharge with voltage dropout.

The primary purpose of the dropout facility is to protect batteries from being excessively discharged.

When the source voltage falls below the Dropout threshold voltage setting, the load will reduce the current it draws to zero. This is a dynamic limit, not a latched state, so if the source voltage recovers above the threshold (as batteries often do) then the load will conduct current again.

To help avoid dropout oscillations, a 5% hysteresis is applied by the SMU on the limit. As such the external source voltage has to increase to above 5% of the dropout level in order to conduct current once more.

If the dropout facility is not required, set the Dropout Voltage to 0 Volts.

Load mode selection

LC	Load Current	The current is the Level setting, independent of voltage.
LP	Load Power	Implements $I = W / V$ where W is the Level setting.
LR	Load Resistance	Implements $I = V / R$ where R is the Level setting.

The following sections give a brief description of the way each mode is implemented and give some guidance of the effect that has on the application of the load.

8 - Manual setup

Load Modes

Load Current (LC)

CNFG > [Source Measure Action] Manual Setup > [Overall] Mode > LC Mode

This is the fundamental operating Load mode of this instrument and has the simplest feedback loop.

When set to Load Current, the SMU provides rapid measurement of power source regulation (V/I characteristics). The sensed voltage signal is only used for the meters and protection.

Load current mode is normally used in conjunction with low impedance power supplies and will be quite stable unless there is significant inductance in either the interconnections or the source. It is critical to have low inductance connections in this mode.

NOTE



The load cannot be used in constant current mode to test a constant current power supply, as this combination has only two stable conditions: if the load setting is below the supply limit, then the supply will not be in constant current operation and will deliver its maximum output voltage, whereas if the load setting is above the limit of the supply, then the load will saturate at its minimum operating resistance with the supply delivering its designed current.

The best way to test a constant current supply is to use the instrument in constant resistance mode.

Load Resistance (LR)

CNFG > [Source Measure Action] Manual Setup > [Overall] Mode > LR Mode

Load resistance mode simulates a standard resistive load by providing a current drain proportional to voltage. Unlike fixed resistors or rheostats, the load provides a precisely controllable resistance with high power dissipation and high temperature stability over a wide value range.

The current rises as the applied voltage rises at equivalent resistance settings.

When rapidly changing the resistance level setting, the required current is inversely proportional to the linearly changing resistance value, so the resulting current waveform is very non-linear, changing rapidly at the low resistance part of the cycle. This rapid change accentuates the effect of inductance in the interconnecting leads and can easily lead to bottoming and overshoots. Resistance mode is best used at higher voltages and modest currents.

8 - Manual setup

Load Modes

Load Power (LP)

CNFG > [Source Measure Action] Manual Setup > [Overall] Mode > LP Mode

When Load Power mode is selected, the SMU simulates a load where the power consumption is independent of the applied voltage. This is true of many types of equipment that incorporate switch-mode regulators. This mode may be particularly suitable for testing power sources of portable devices such as Lithium-ion batteries.

Load Power mode is implemented by the very fast digital feedback loop, used to divide the specified power setting by the actual sensed voltage to calculate the necessary current. If the external source voltage falls, then the load will seek to keep the same power level by reducing its resistance to raise the current. The fact that the current rises as the voltage falls means that the load is acting as a negative resistance. This behaviour is also exhibited by most switch-mode power supply circuits.

This characteristic raises the possibility of a latch-up condition if the external source has a significant output impedance. To explain this, consider the possibility that the external source voltage falls slightly (perhaps because of noise) – the load responds by increasing the current to maintain the power level. This causes a further reduction in the terminal voltage of the external source (because of its internal impedance), so the increase in power is less than expected. The load responds to this by reducing its resistance even more, in an attempt to increase the current and obtain the required power. A cross-over point is reached when the fall in voltage outweighs the increase in current and the load cannot draw the required power. This leads to the latch-up condition, with the load at its minimum resistance (nearly a short-circuit), the voltage across it almost zero, and the source is delivering its maximum current into the almost short-circuit load.

If the source impedance is purely resistive then this condition will be triggered when the source terminal voltage falls to half its open circuit voltage (this is the maximum power transfer condition of classical electrical theory). More commonly, it will also be triggered immediately if the external source reaches a current limit or enters constant current operation.

The only way to recover from this situation is to disable either the load input or the external source output.

To avoid immediately entering the latch-up condition, it may be necessary to reduce the slew rate setting to constrain the power demand while the source builds up its output voltage.

As Load Power mode has the characteristics of a negative resistance, the possibility always exists of forming a negative resistance oscillator in combination with the output impedance of the external source. In practice, constant power mode normally operates well in conjunction with sources designed to supply such a load.

8 - Manual setup

Measurement Modes

Measurement Modes

Measure Voltage (MV)

CNFG > [Source Measure Action] Manual Setup > [Overall] Mode > MV Mode

When set to Measure Voltage mode, voltage measurements are made using the MAIN HI and the MAIN LO terminals. Multiple measurement ranges (auto or manual) are available from 20mV to 20V [SMU4001]/200V [SMU4201]. See '*Selecting a Range*' for more details. MV mode effectively selects the internal current source and sets the current level to 0A.

Measure Current (MC)

CNFG > [Source Measure Action] Manual Setup > [Overall] Mode > MC Mode

When set to Measure Current mode, current measurements are made using the MAIN HI and the MAIN LO terminals. Nine measurement ranges (auto or manual) are available from 200nA to 3A. See '*Selecting a Range*' for more details. MC mode effectively selects the internal voltage source and sets the voltage level to 0V.

Measure Resistance and High Resistance (MR & MHR)

CNFG > [Source Measure Action] Manual Setup > [Overall] Mode > MR Mode

CNFG > [Source Measure Action] Manual Setup > [Overall] Mode > MHR Mode

When set to Measure Resistance mode, the SMU utilizes the internal current source, designed to measure low resistance values at high current levels.

When set to Measure High Resistance, the SMU mode utilizes the internal voltage source and is designed to measure high resistance values at high voltages.

There are no specific resistance measurement ranges.

Careful consideration of the terminal configuration is required for resistance measurement. However, if in doubt always use the 4-wire terminal configuration.

Normal (2 wire) resistance measurements are made using the MAIN HI and the MAIN LO terminals. This measurement mode is appropriate for higher resistance measurements, and for lower resistance measurements where high precision is not required.

4 wire measurements are appropriate for precision measurement of low resistances where the effects of the connecting leads and contact resistances are significant. 4 wire measurement uses the HI and LO SENSE sockets in addition to the MAIN HI and LO INPUT sockets. See *Terminal s* for more details.

Because no significant current is flowing through the SENSE connections when utilising 4 wire measurement, contact resistance does not affect the measurement result.

8 - Manual setup

Terminal selection

Terminal selection

CNFG > [Source Measure Action] Manual Setup > [Overall] Terminals

2 and 4 wire setup

The terminal configuration determines the measurement sensing scheme.

Terminal configuration options are as follows:

- 2 wire (Default)
- 2W+Guard [2 wire plus guard]
- 4 wire

It is recommended to use 4 wire measurement when it is essential to measure the voltage delivered to a load independent of any voltage drops in the connecting supply wires or contacts.

This is important when sourcing low voltages, sourcing high currents and in very low impedance applications.

Contact resistance does not affect the measurement result as no significant current is flowing through the SENSE connections when utilising 4 wire measurement.

Connections can be made from either the front or rear of the instrument.

WARNING



Only ever use either the front or rear terminals, never use both at once. Hazardous voltages will appear on both sets of terminals.

Hazardous voltages will appear on both sets of terminals.

Always make connections to the instrument with the OUTPUT off and in the Open off state; this is the only output state that completely isolates the external circuitry from the instrument.

Guarding

Guarding can be used for very low current and high impedance applications where potential unwanted leakage, stray capacitance or magnetic coupling may be a problem. It can be a way of effectively reducing the leakage current and capacitance that can be present between the MAIN HI and LO signals.

Use guarding for isolating impedances that you do not want to measure.

WARNING



The Guard signal (rear panel and 2 wire plus guard) is driven to the same potential as the MAIN HI. As such, if the MAIN HI is at a hazardous voltage, the same hazardous voltage level will also be present at the Guard.

NOTE



Specific Guard terminals only feature on the rear panel. The HI SENSE terminal can be used as a guard through the 2 wire plus guard terminal configuration.

8 - Manual setup

Measurement count

Measurement count

CNFG > [Source Measure Action] Manual Setup > [Overall] Meas. Count

The Measurement count defines the number of measurements to make per source level setting applied.

The count can be set to an integer number or can be set to infinite to provide an infinite number of continuous measurements based upon a single source level setting.

NOTE



When a shape waveform other than steady is chosen the count cannot be set to infinite. A shape waveform only executes and applies the next source level setting once all measurements for the existing level setting are complete, as such setting the measurement count to infinite would result in only the first source level setting ever being applied.

In steady shape operation any new source level set immediately overrides the existing level setting irrespective of how many measurements have been made. If the output is running and the number of counts is set to a finite number, the new level setting will automatically trigger the specified number of counts at that new level, regardless of the number of measurements already made. However, the 100k measurement buffer limit still applies, any measurements beyond this limit will be ignored.

8 - Manual setup

Source shape

Source shape

CNFG > [Source Measure Action] Manual Setup > [Source] Shape

The Shape selection defines the source level shape.

Source level shape options are as follows:

- 'Steady' (Default)
- 'Pulse'
- 'Sweep'
- 'Pulsed Sweep'
- 'List'

Number of Shapes

The number of shapes defines the number of times a configured wave shape is sourced. This can be set when a shape waveform other than **Steady** is selected.

8 - Manual setup

Source shape

Steady

When a steady shape is selected, the SMU provides a continuous stable source level. The Level can be updated from the Manual Setup screen and the Home screen. When the output is enabled, “real-time” adjustments can be made from the Home screen, see ‘Live adjusting source and limits from the home screen’.

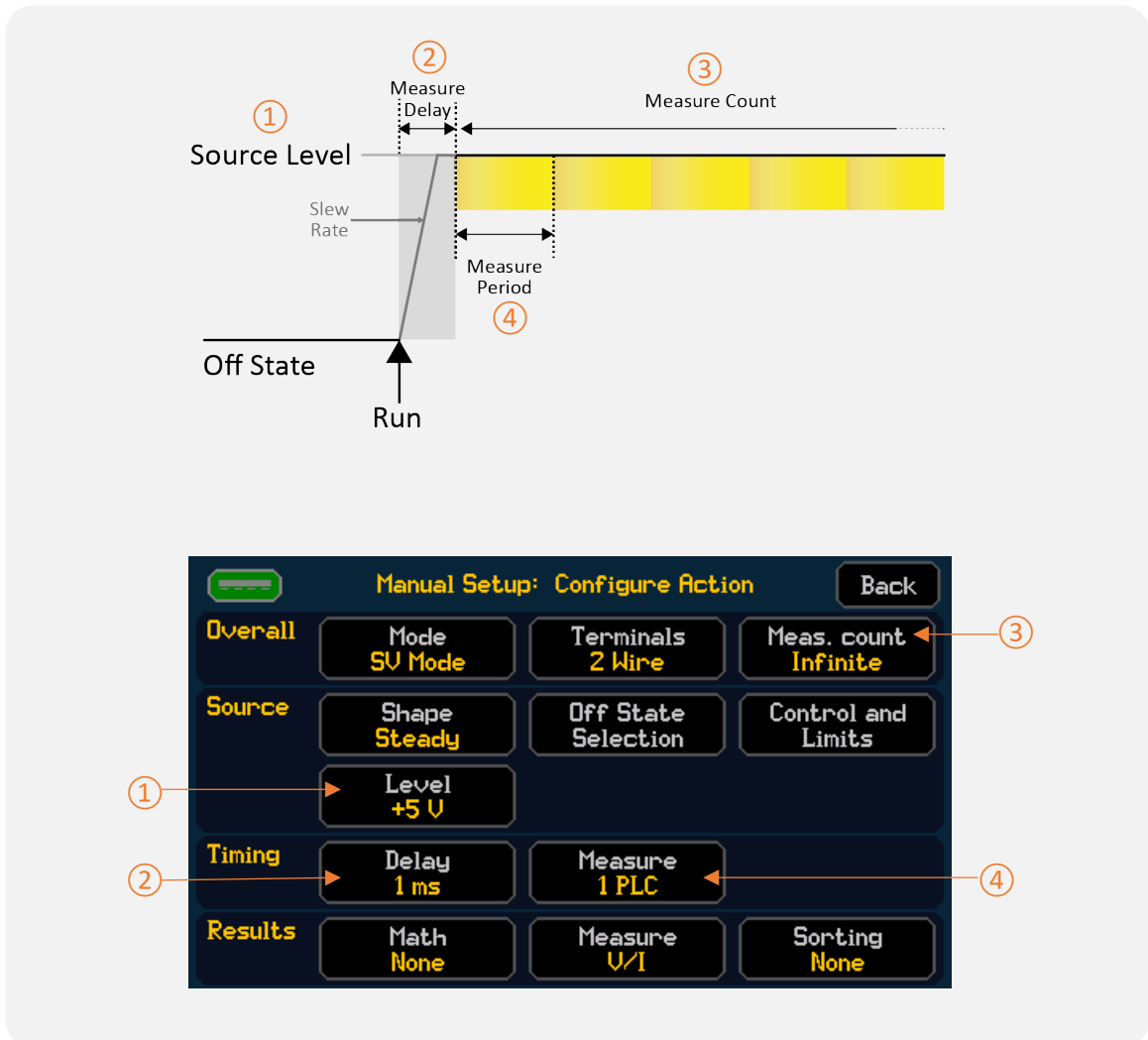

8 - Manual setup

Source shape

Pulse

When a Pulse shape is selected, the SMU provides a pulsed source between two set levels with variable width control of both set levels.

Settings

The effective width of each pulse level is controlled by the pulse level measurement setting. This is equivalent to the measurement period but is separated into two individual settings, one for each level. The pulse Levels (1st and 2nd) can be updated from the Manual Setup screen and the Home screen. When the output is enabled, “real-time” adjustments can be made from the Home screen, see ‘Live adjusting source and limits from the home screen’.

Timing

All pulse timing is based upon the settling/ measure delay, pulse level measurement period and measurement count. The measure delay shown in the following diagram shows a user defined measure delay. Alternatively an automatic settling delay can be selected. See ‘Timing options’ for more details.

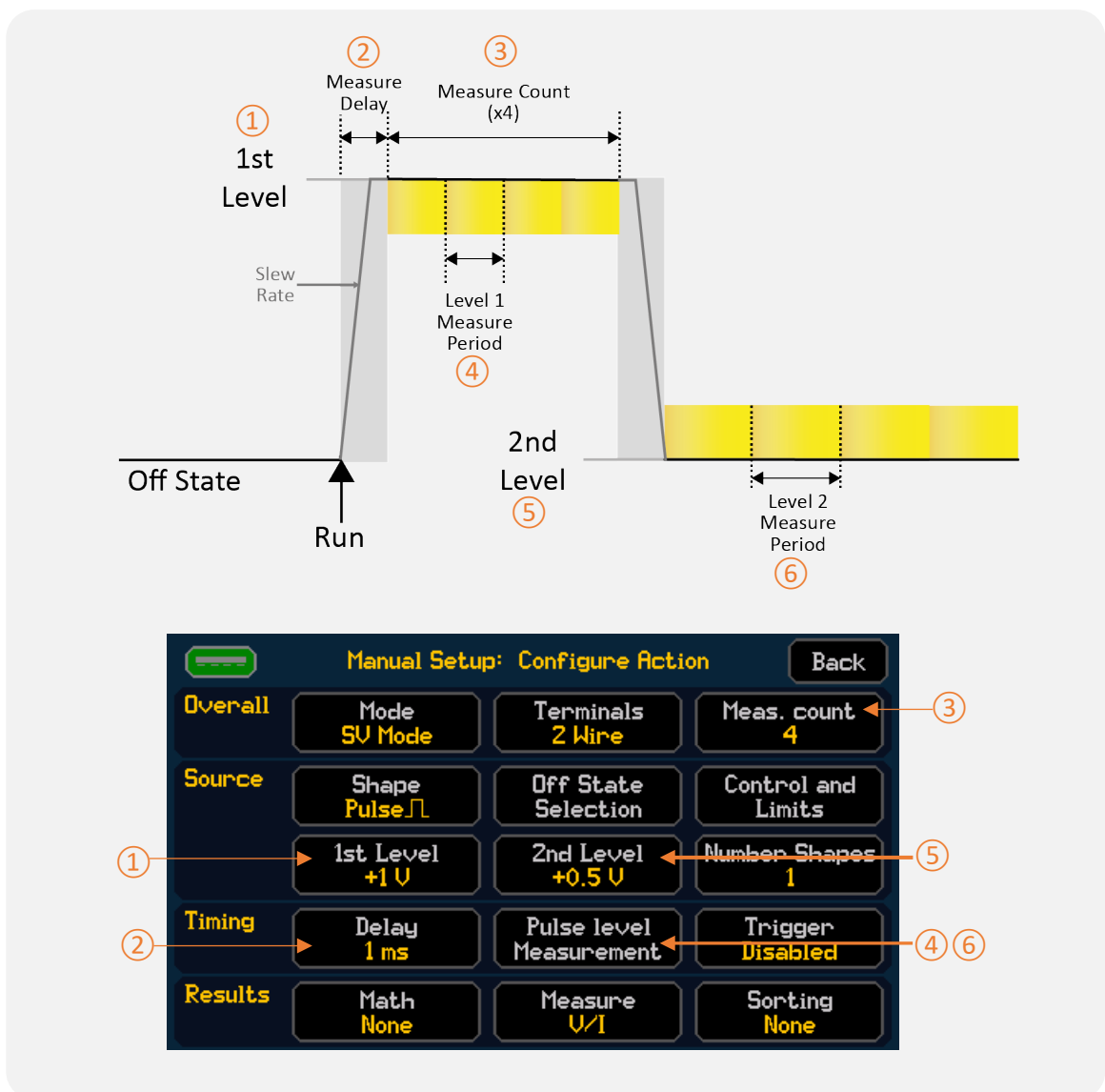

8 - Manual setup

Source shape

Sweep

Sweep provides a swept source level in steps between defined start and end levels. The Sweep Setup menu provides all the options for configuring the source sweep.

Settings

The Sweep setup options are as follows:

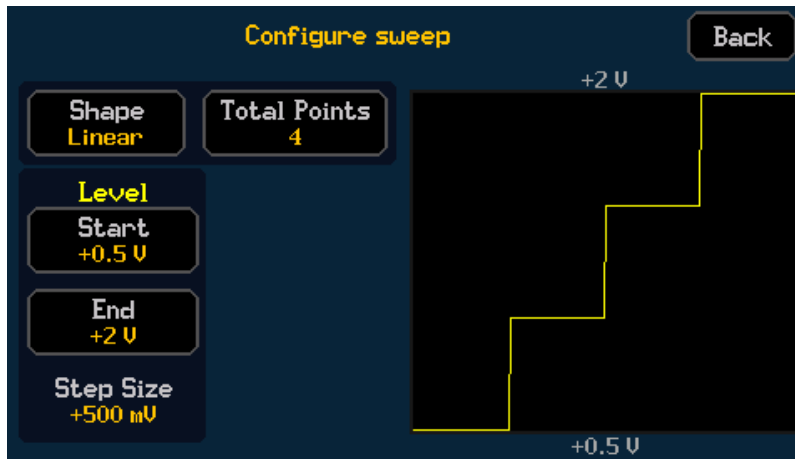

The step size is updated when the sweep settings are changed.

Linear / Logarithmic

Step size = (stop-start) / (points-1)

Dual linear / Dual logarithmic

Selecting Dual linear or logarithmic shape provides a swept source level in steps between defined start and end levels, and back to the start level.

NOTE



The number of points in a dual sweep refers to the total number of points—from the start to the end and back to the start. When using a dual sweep, the total number of points must be an even number ≥ 4 for dual, ≥ 2 for single.

8 - Manual setup

Source shape

Timing

The sweep configuration menu contains no timing control, all single sweep timing is based upon the settling/ measure delay, measurement period and measurement count. The measure delay shown in the following diagram shows a user defined measure delay, alternatively an automatic settling delay can be selected, see 'Timing options' for more details.

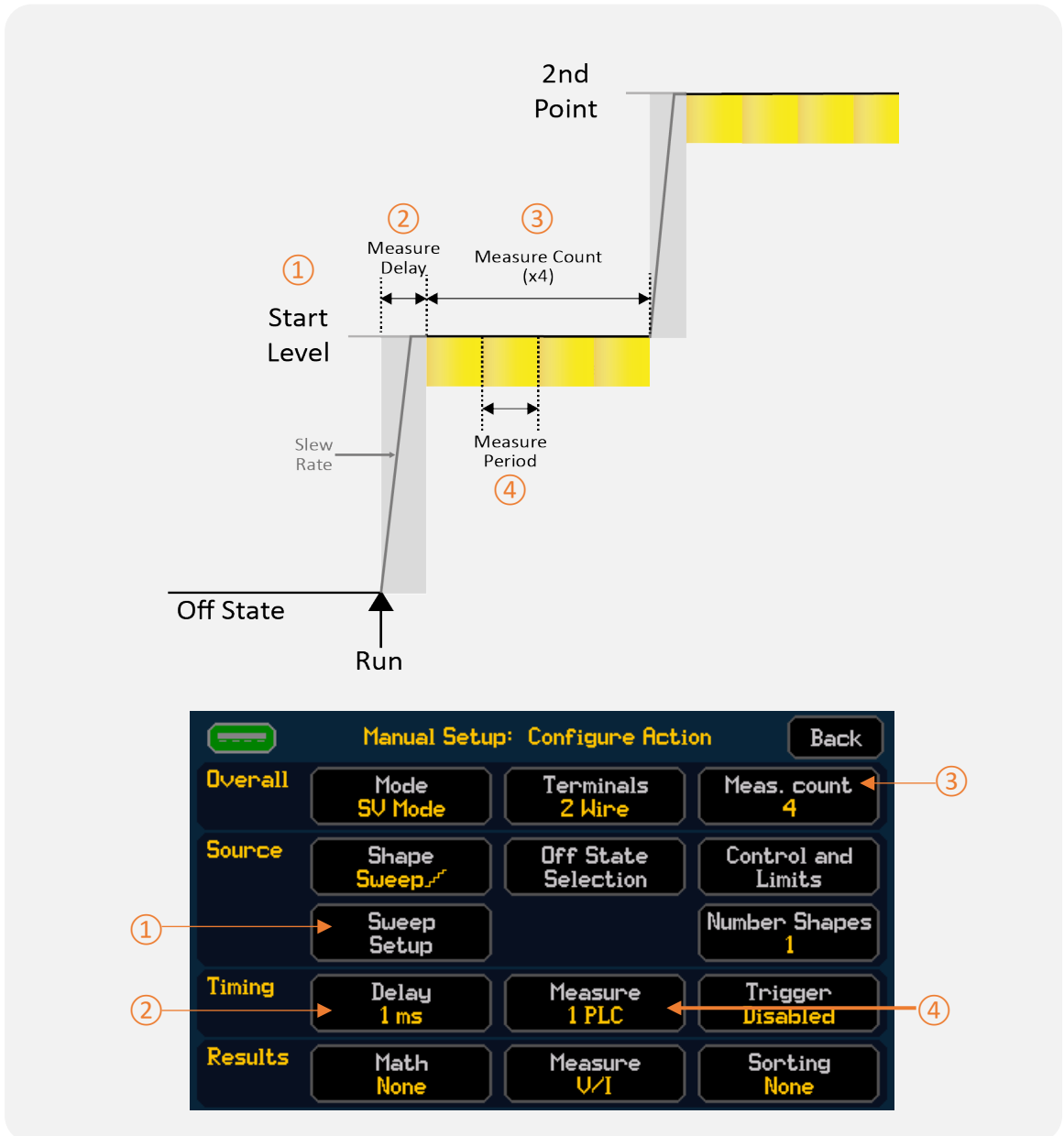

The time it takes to complete one single sweep can be calculated by = (Number of Points x (Settling Delay + (Measurement Period x Measurement Count))).

8 - Manual setup

Source shape

Pulsed Sweep

A pulsed sweep works in a similar way to a sweep- it provides a swept source level in steps between defined start and end levels. However, after each sweep level is complete the level returns to a user defined steady level.

One problem when testing a device using a standard sweep is that during the sweep the temperature of the device under test can change due to the applied source. Pulsed sweep helps to alleviate this issue by returning to a defined steady level after each sweep step so that the DUT can return to its resting temperature.

Settings

The Pulsed Sweep setup options are as follows:

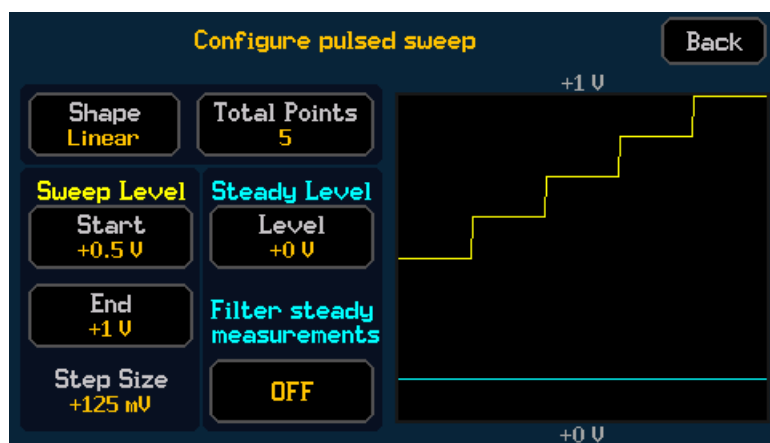

The step size is updated when the sweep settings are changed.

Linear / Logarithmic

Step size = (stop-start) / (points-1)

Dual linear / Dual logarithmic

Selecting Dual linear or logarithmic shape provides a swept source level in steps between defined start and end levels, and back to the start level.

NOTE



The number of points in a dual sweep refers to the total number of points-from the start to the end and back to the start. When using a dual sweep, the total number of points must be an even number ≥ 4 for dual, ≥ 2 for single.

Steady Level

Additional options available with a pulsed sweep are a settable steady level and the option to filter the steady measurements.

In most situations there is very little use for the pulse sweep steady level results, as such the filter steady measurements option allows for the steady level measurements to be filtered out and discarded from the results buffer.

8 - Manual setup

Source shape

Timing

The pulsed sweep configuration menu contains no timing control, all single pulsed sweep timing is based upon the settling/ measure delay, pulsed sweep measurement periods (sweep level measurement period and pulse steady level measurement period) and the measurement count. The sweep level measurement period and pulse steady level measurement period are separated to allow the sweep and steady periods to be completely independent. In situations where temperature may be an issue the pulse steady measurement period may be extended significantly to allow time for the DUT to cool sufficiently. The measure delay shown in the following diagram shows a user defined measure delay, alternatively an automatic settling delay can be selected, see 'Timing options' for more details.

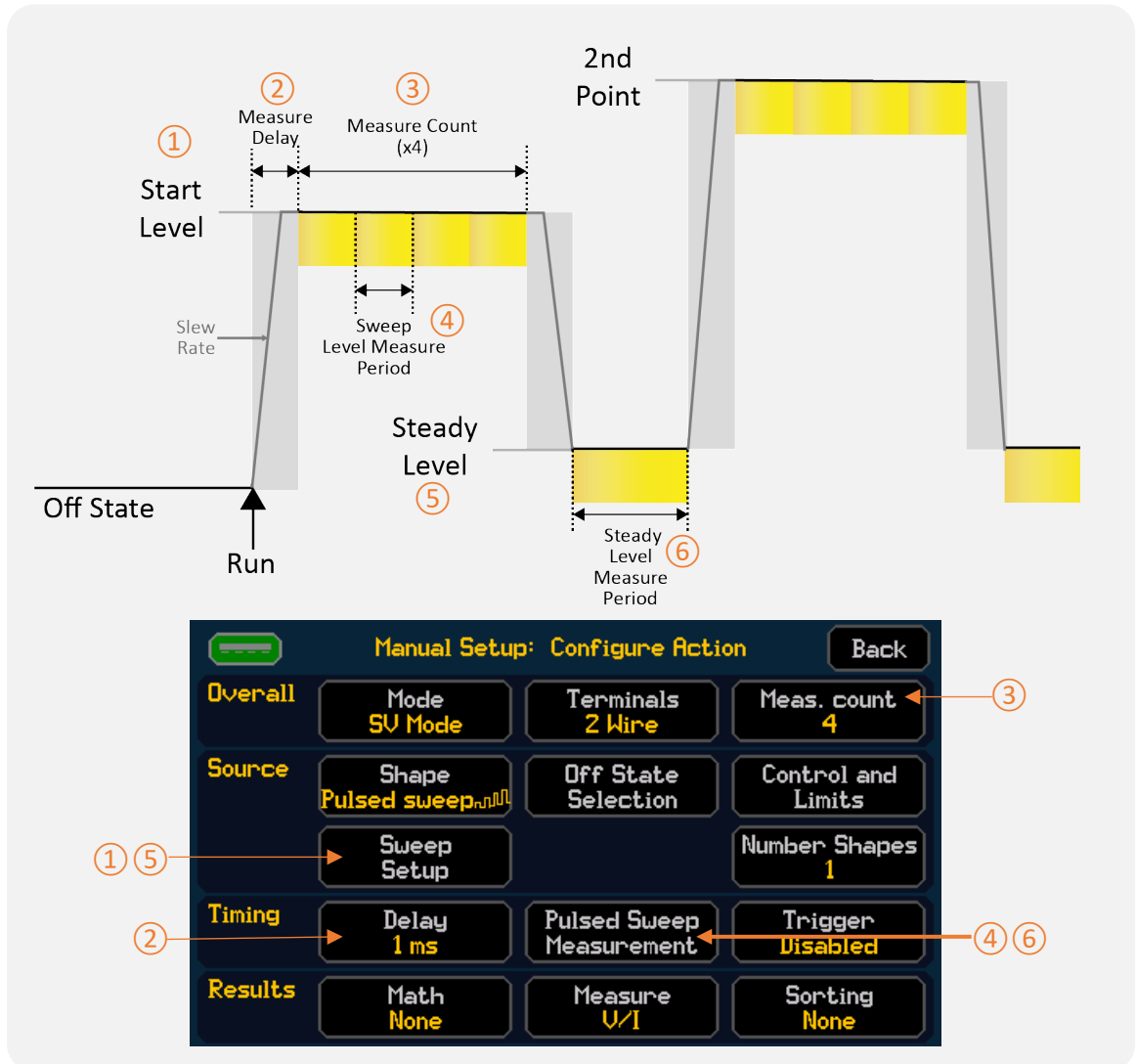

The time it takes to complete one single sweep can be calculated by = (Number of Points x ((Settling Delay x 2) + (Sweep Measurement Period X Measurement Count) + (Pulse Steady Level Measurement Period))).

NOTE



Only one measurement is made at each pulsed sweep steady level, regardless of the measurement count setting. When calculating pulse sweep timing take note that there is a settling time delay for both the sweep and steady level, however one delay setting covers both.

8 - Manual setup

Source shape

List

When a List Shape is selected, the SMU provides a source level that is swept through a user defined list of levels.

The list manage menu allows for user configured arbitrary lists to be recalled from non-volatile internal memory and from the USB flash drive.

The arbitrary list is imported as a .CSV file which can be manually created or created via the Test Bridge application (available to download from www.aimtti.com).

Arbitrary lists are not linked to a mode, nor do they contain any timing information. They are a list of arbitrary levels up to a maximum length of 100k points. All timing is based upon the settling delay, measurement period and measurement count as defined in the manual setup. The list will be transferred as points into the selected mode, for example if the SMU is in SV the points will be converted to voltage.

NOTE



Due to the fact that a list can be imported into any mode with sourcing capability, the instrument checks each level against the allowable limits given the mode and ranges selected, to ensure each level is within the specified limits. This is not done on import but upon running the output. If a limit breach is detected, a warning is generated, and the output fails to run.

If a setup containing a list is copied internally or externally from the SMU (.STP & .CSV file) both files will be copied. The associated files will need to be present to run the setup, if the associated .CSV file is missing the setup will fail to run.

Loading a List

CNFG > [Source Measure Action] Manual Setup > [Source] Shape > (List) > List Manage

The List Manage menu allows for Lists, in the form of a .CSV file, to be:

- Imported from a USB Flash Drive.
- Loaded from the Internal Memory.
- Deleted from the Internal Memory.
- Exported to a USB Flash Drive.

NOTE



SMU measurement data stored on a USB Flash Drive can be recalled as a list of points, once stored internally.

8 - Manual setup

Source shape

Import a List from a USB Flash Drive

List (.CSV) files can be imported from the USB Flash Drive to the Internal Memory.

NOTE



A file must be imported into the Internal Memory before it can be loaded as a List.

To import a file, select the file to be imported ①. Once selected the file name will be surrounded with a green box, press **Store Internal** ② to import.

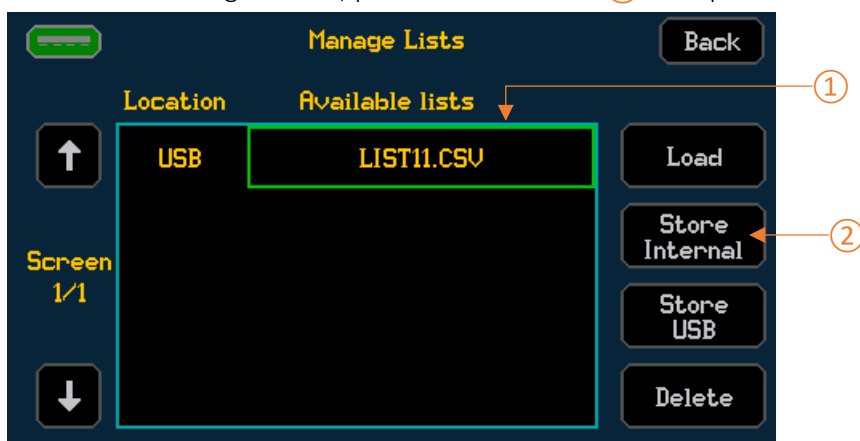

The file will appear in the **Available Lists** column, with **Internal** as the location.

NOTE



External USB Files cannot be loaded or deleted using the store setup menu.

Load a List from the Internal Memory

To recall a List from the Internal Memory, select the required list ①, followed by **Load** ②. A pop-up box will appear to confirm the action.

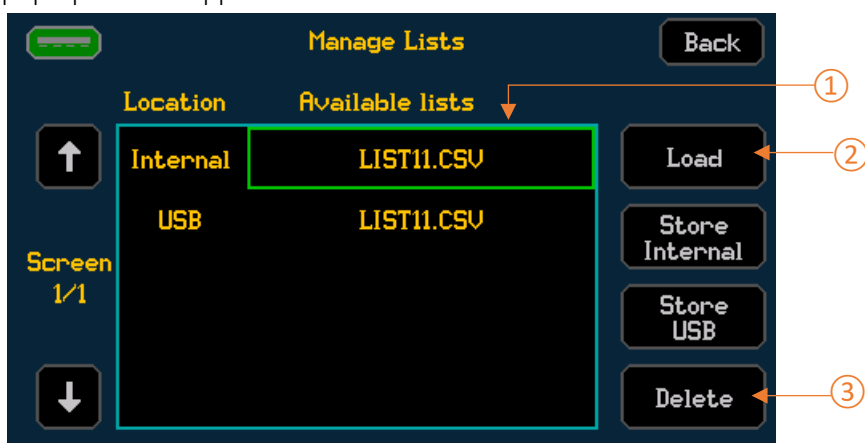

NOTE



Recalling any stored list will override the existing configuration.

Delete a List from the Internal Memory

To delete a List from the Internal Memory, select the required list, followed by **Delete** ③. A pop-up box will appear to confirm the action.

8 - Manual setup

Output Off state

Output Off state

CNFG > [Source Measure Action] Manual Setup > [Source] Off State

The off-state configuration determines the state of the source and terminals when the output is disabled.

Even when the output is disabled, this does not guarantee that the instrument is fully isolated from the external circuitry.

If any trip condition occurs, the instrument goes straight into the **Open** output off state.

By default, no measurements are stored in the results buffer whilst in an off condition; the measurement buffer will only be populated whilst the output is running. During the off condition the measurement buffer will be populated with the results from the last time the output was run.

If measurements are required whilst the output is off, this can be set using the Measurement button in the Output off State menu, see '*Measurement*'.

NOTE



Off state measurements will never appear in the results buffer. They will appear on the home screen in the results box, or can be queried via SCPI remote command.

NOTE



The output off state will be applied to the selected operating mode, changing the mode of operation may also change the output off state.

Not all off states are available in each mode.

There are a total of 4 output off states that can be chosen from –

Open- This is the only output state that completely isolates the external circuitry from the instrument. In this state all of the terminals are made open circuit and no terminals are monitored.

It is important to note that selecting Open as the off state does add a small delay to the output response time for the guaranteed opening and closing of relays.

This is dealt with automatically without the need to set a measurement delay. To help prolong the life of the relay, avoid using the Open off state when frequent enabling and disabling of the output is required.

Hi Z - This is a high impedance state where effectively SC mode is engaged, and the source current is set to 0.0nA. For modes that have a voltage limit (SC and MR) the voltage limit is set to the user defined limit setting. For all other modes the voltage limit is set to the maximum allowable voltage given the status of the HV interlock, or the maximum allowable voltage for the SMU4001. Note that when the terminals are left open circuit the voltage may drift around significantly due to the very high input impedance.

8 - Manual setup

Output Off state

0V/100uA – This is a zero-volt state where effectively SV mode is engaged, and the source voltage is set to 0V with a current limit of +/- 100uA. The +/-100uA limit only applies when the current range selection is set to auto. If manual current ranging is selected, then the limit is set to +/-10% of the full-scale of the selected range.

Zero - This is a zero-volt state where effectively SV mode is engaged, and the source voltage is set to 0V with a user defined current limit. For modes that have a current limit (SV and MHR) the current limit is set to the user defined limit setting. For all other modes the current limit is set to the maximum allowable current of the instrument.

This mode can be used to discharge components such as capacitors and also remove any unwanted charge stored within semiconductor devices between tests.

All off conditions (other than OPEN) utilize the same relevant manual setup settings. For example the terminal configuration, slew rate, high reactance state, protection limits and range selection will all match the existing manual setup configuration. One exception to this is that during the off condition the measurement period is set to 10PLC when off condition measurements are enabled.

CAUTION



Always take special care and consideration when configuring the output off state. This is especially true when connecting to an external power source, this could be anything from a discrete voltage source (PSU) to a capacitor or battery. For example, selecting the Zero output off state when connected to an external voltage source will cause potentially very high levels of current (up to the defined SMU current limit) to be drawn from the external voltage source. Failure to take consideration of the output off state and the associated settings could result in damage to the device under test.

Measurement

When Hi Z, 0V/100uA or Zero off state is selected, the buffer can be set to record the measurements in the data buffer when the output is off.

NOTE



If measurements are enabled whilst the output is off, they will not appear in the measurement buffer, only on the home screen in the results box.

8 - Manual setup

Source Control

Source Control

CNFG > [Source Measure Action] Manual Setup > [Source] Control and Limits

The control and limits menu contains options for source timing and control, limits, and protection. Here the user will find options (depending on selected mode) for slew rate, high reactance, current and voltage limits, dropout, OVP, OCP and OPP protection trips.

NOTE



Not all options and settings are available in each mode.

Slew Rate

The slew rate is the maximum rate at which the source output can change from one level to the next.

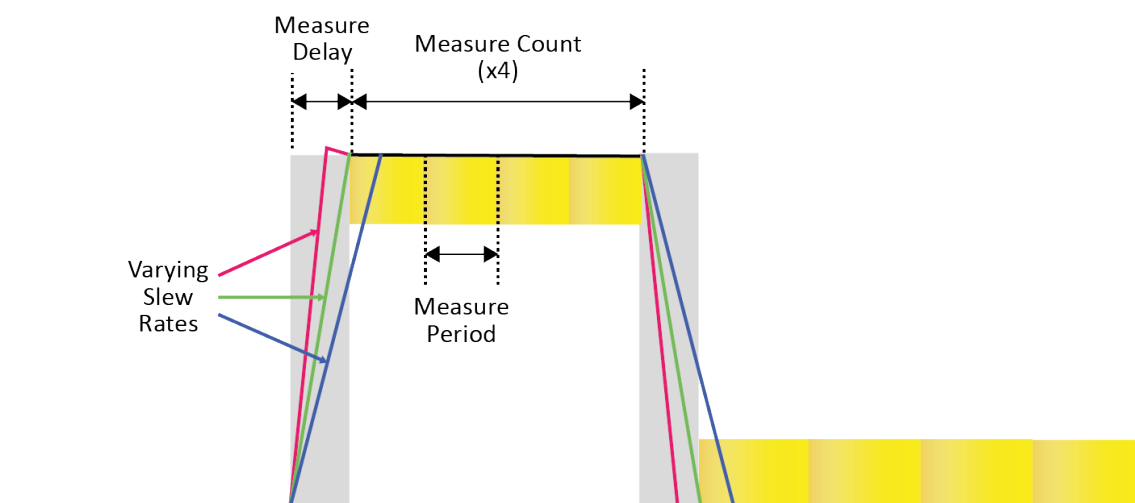

It is important to note that this is a maximum setting and does not precisely define the rate of change, as the source output transition rate can be affected by other factors including output level, load level, voltage, and current and load reactance.

The slew rate setting can be utilised to tame fast edges and help prevent instability.

High reactance mode

When attempting to source into a highly reactive load which may be capacitive or inductive there may be visible overshoot, ringing or even in some cases instability.

Enabling High Reactance mode helps to compensate for and reduce the risk of these issues. With High Reactance Mode enabled the instrument uses a lower bandwidth with reduced compensation speed and increased settling times to provide more robust performance with higher capacitive and inductive loads.

NOTE



Enabling High Reactance mode can directly affect the instrument rise and settling times. Fastest instrument performance can only be achieved when High Reactance mode is disabled. High reactance mode can also lead to a noisier output and a slower response to changes in load due to reduced compensation.

8 - Manual setup

Source Control

Measurement Control

The measurement control setting gives the ability to control the state of the source once all required measurements have been successfully completed.

There are two options available, the output is either disabled (OFF) or the output continues to keep sourcing the last set level with no further measurements made (Constant level).

NOTE



The constant level option can be particularly useful within sequence mode when it is desired that the output remains at the same level between steps and does not disable. This is only possible if the Mode does not change between steps.

In this particular situation the mode must remain the same for the next step to ensure the output remains active.

8 - Manual setup

Limits and Protection

Limits and Protection

CNFG > [Source Measure Action] Manual Setup > [Source] Control and Limits

Various methods of protection are provided to protect the test setup from damage by unexpected occurrences.

Limits

The limit setting (also known as compliance) provides a limit to ensure that the instrument cannot source or sink a voltage or current beyond that set limit.

The main purpose is to prevent damage to the device under test when set to a suitable level.

For both voltage and current limits there is only one setting to cover both polarities which provides dual polarity limiting. For example, setting a limit of 1A, sets the dual polarity current limits to +/- 1A.

When a limit is breached the source voltage/ current is restricted to the limit setting, the corresponding CV / CC LED is illuminated, VLIMIT/ ALIMIT is shown in the results box of the home screen and the colour of the appropriate measurement on the home screen is changed to orange. Both computed readings (power and resistance) also turn orange.

The limit is not latched and can recover if the source level is reduced or the load changes accordingly.

When manually selecting ranges, the limit level can be set between 10% and 105% of the selected range.

The combination of the source and limit level settings cannot exceed the instruments maximum power of 25W.

Limits can be added depending on the mode of operation:

Mode	Limits
SV (Source Voltage)	Current limits for both polarities
SC (Source Current)	Voltage limits for both polarities
LC (Load Current)	Voltage dropout
LR (Load Resistance)	Current limit and Voltage dropout
LP (Load Power)	Current limit and Voltage dropout
MV (Measure Voltage)	-
MC (Measure Current)	-
MR (Measure Resistance)	Voltage limit for both polarities
MHR (Measure Resistance)	Current limit for both polarities

NOTE



Setting a limit too close to the desired output level can result in extended source rise times. The source is slewed slightly when approaching (and predicting to exceed a limit) in order to enter the limit smoothly. Changing the limit in real time can also temporarily extend consequent source level change rise times. Ideally delay any source changes by 250ms after changing the limit, to maintain expected rise times.

8 - Manual setup

Limits and Protection

Protection

There are three user settable digital protection limits:

- Over Voltage protection
- Over Current protection
- Over Power protection

These can be applied to each mode of operation. These can be set to a specific level or set to **Disabled**. If set to disabled, the trips are set accordingly:

[SMU4201] Voltage HV = 220V , Voltage LV =44V [SMU4001] 22V

Current = 3.3A

Power = 27.5W

Each of these protection limits are continually checked against the raw measured Voltages and Current and computed Power readings. The measurement period and delay have no effect on the trip response.

The trip response time is typically <200 μ s, regardless of any user settings.

NOTE



OVP Trip protection is based on the voltage measurement which can be affected by the terminal configuration.

NOTE



Trip protection applies to the mode of operation, when the mode is changed, the protection will change to the settings in the selected mode.

There is also an integrated internal over temperature protection limit. The instrument can overheat if the ambient temperature exceeds the recommended operating range limit stated in the specification, or if the ventilation is restricted.

When these protection limits are exceeded, the output is tripped and the 'off state' is set to OPEN, thus completely isolating the external circuitry from the instrument.

When tripped, a protection trip pop-up message is displayed and recorded in the 'Event log'.

The protection trips are not latched, once the trip has occurred, the output can be re-enabled but there's no guarantee that the trip won't happen again.

Whenever a temperature trip occurs, it is advised to leave the instrument to cool down before re-enabling the output. It's also worth investigating the potential cause of the temperature trip to see if it can be alleviated by ensuring all ventilation is unrestricted.

If one of the voltage, current or power trips occurs unexpectedly, this may be a result of instability, for information on how to overcome potential instability see '*Application notes*'.

8 - Manual setup

Source Level

Source Level

CNFG > [Source Measure Action] Manual Setup > [Source] Level

The level setting represents the present source level.

This is only available in modes that utilize the source i.e., not MV or MC modes.

The level can be set and edited when the shape is configured as Steady or Pulse from either the Home screen or the Manual Setup menu. When the output is enabled, “real-time” adjustments can be made from the Home screen, see *‘Live adjusting source and limits from the home screen’*. However, take note that in Steady shape, changing the source value will update instantaneously regardless of measurement counts.

8 - Manual setup

Timing options

Timing options

Delay

CNFG > [Source Measure Action] Manual Setup > [Timing] Delay

The Delay defines the measurement delay, also known as the source settling time delay.

This delay provides a time delay between the source being enabled (Run) or changed in terms of level and the first measurement at this new level being made. Essentially, this provides a settling time for the source to reach its aiming value and settle.

The delay time can be set between 200us and 5s.

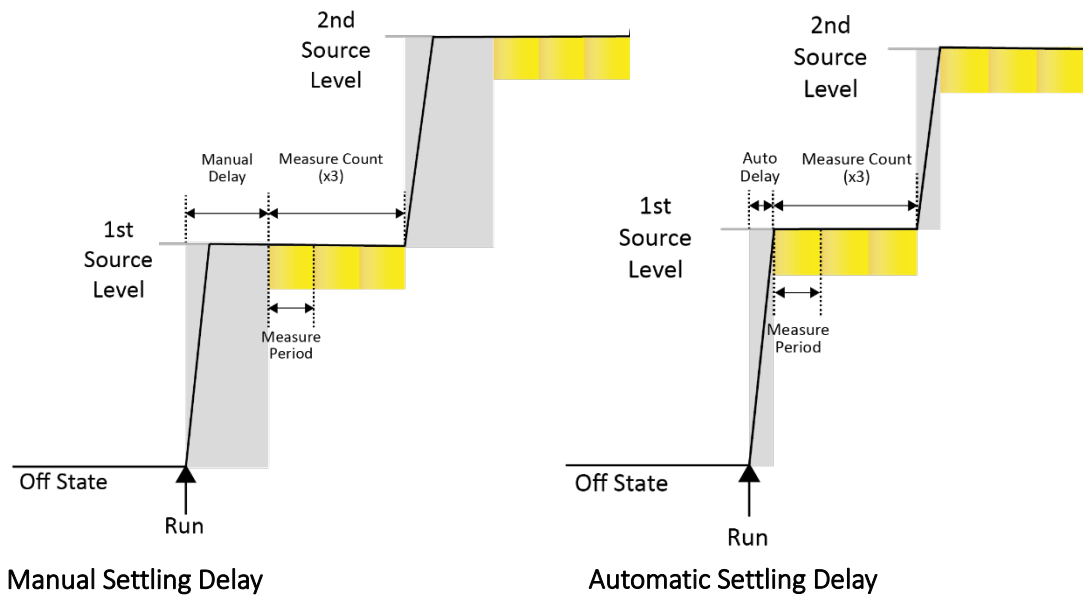

The actual source settling time is dependent upon many factors including mode, slew rate, load, magnitude of change, polarity change etc. As such, careful consideration needs to be made when deciding upon the delay. See '*Specification*' for more details on source settling times.

To simplify this setting an Auto Delay feature is included. As opposed to defining an exact settling time delay, the delay can be set to Auto. This automatically delays the first measurement of the new source level until it appears that the output has settled to the desired level for each measurement.

This should be the most suitable and the default setting for most applications. However, if accurate/repeatable timing is required then it is recommended that a fixed delay is set. The auto delay feature is measurement dependant, as such it can vary from level to level.

The auto delay function can only delay for a maximum of two seconds. This can occur if the source output exceeds a user defined limit and never reaches the desired source level.

NOTE



When the off condition is set to Open, the relay switching delay is dealt with automatically and requires no additional measurement delay to cater for the relay switchover. However, a delay may still be required for allowing the source to settle.

8 - Manual setup

Timing options

Measurement Period

CNFG > [Source Measure Action] Manual Setup > [Timing] Measure

The Measurement period also known as aperture or integration time defines the amount of time that each measurement is measured and averaged for. The entry can be made in terms of seconds or number of power line cycles (PLC).

Accuracy of measurements can be affected and reduced by power line induced AC noise, this effect can be counteracted by increasing the measurement period, however only an integer number of PLC values provide mains power line rejection.

One PLC for 50Hz is 20ms and one PLC for 60Hz is 16.67ms. Mains input frequency is automatically monitored and applied by the instrument. Matching and tracking the PLC measurement period to the exact mains frequency period will remove as much power line generated interference and noise as possible.

The measurement period is a trade-off between measurement accuracy and measurement speed.

8 - Manual setup

Timing options

Trigger

CNFG > [Source Measure Action] Manual Setup > [Timing] Trigger

The global trigger functionality allows for triggered control of the timing of shape waveforms.

The trigger can be used to control the stepping through of the points of a shape waveform, in this case an input trigger event is required in order for the source setting to move onto the next level.

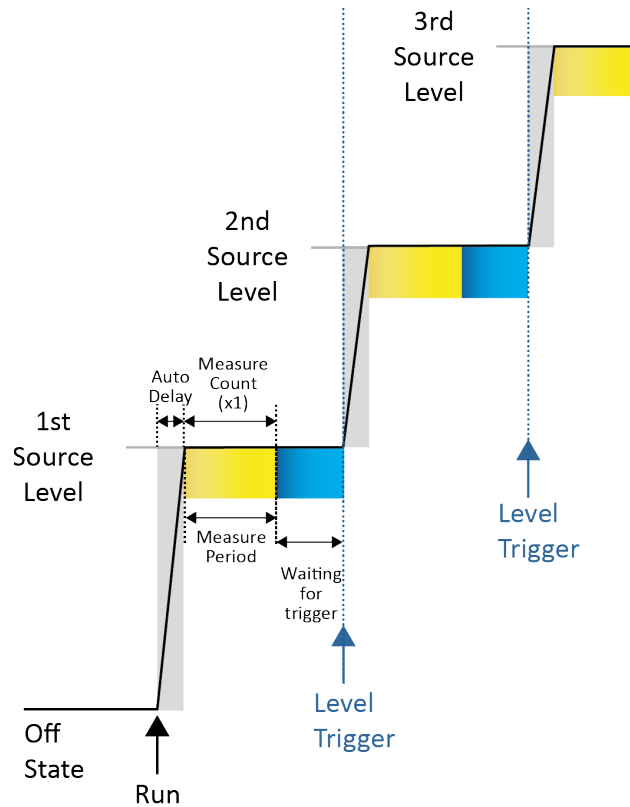

The input trigger can also be used to repeat shape waveforms, in order to source the next waveform shape.

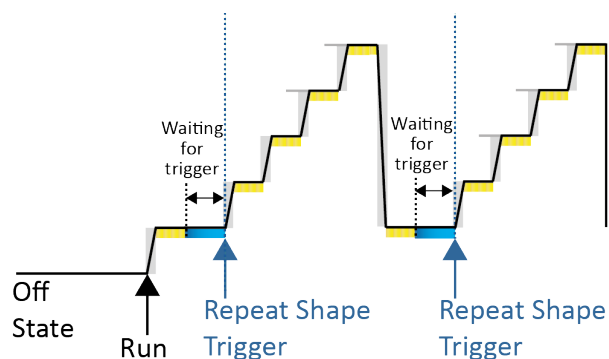

The global input trigger event can be provided by remote command using the command `SYST[em]:TRIG[ger]` or from pin 8 on the DIO port.

Once the event has been triggered and all associated measurements to that event have been made, the instrument sets a global trigger output on PIN 7 of the DIO port.

This combination of global trigger in and trigger out allows for the handshaking of multiple instruments. For more information see '*Digital I/O*'.

8 - Manual setup

Sequence mode

Sequence mode

CNFG > [Source Measure Action] Manual Setup > [Overall] Mode > Sequence Mode

Overview

The Sequence Mode menu allows for the setup and configuration of a sequenced model. This is created using user stored configuration setups that are loaded into the sequence model to create a base for the additional actions.

To start creating a sequence either **Insert** ① (position before) or **Add** ② (position after) a step.

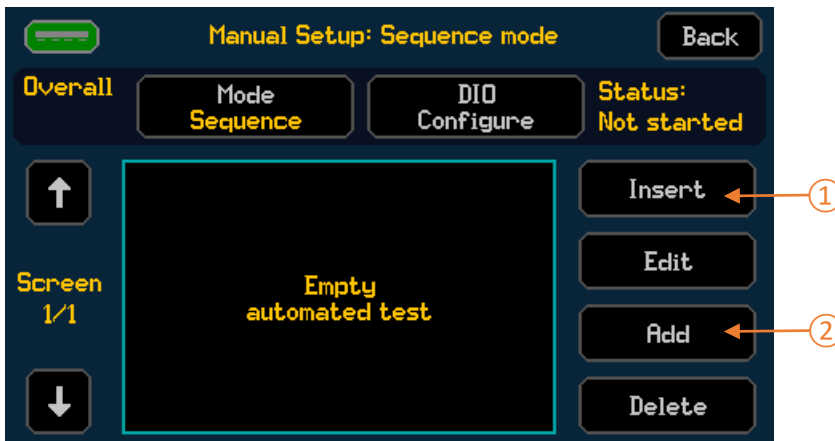

The sequenced model allows the user to run multiple configurations, set delays, repeat, and jump to and from steps, create multiple triggered events and set output statuses.

NOTE



Each step must have a setup added, only one configuration setup can be added to each step.

Select **Setup** ① and load a saved setup file to start the sequence to activate the **Action** and **Condition** options.

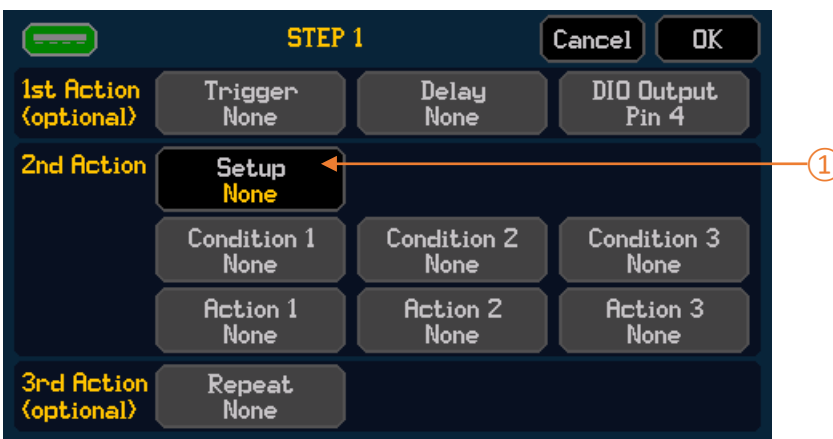

8 - Manual setup

Sequence mode

Once a setup has been added, actions and conditions can be added to the sequence step.

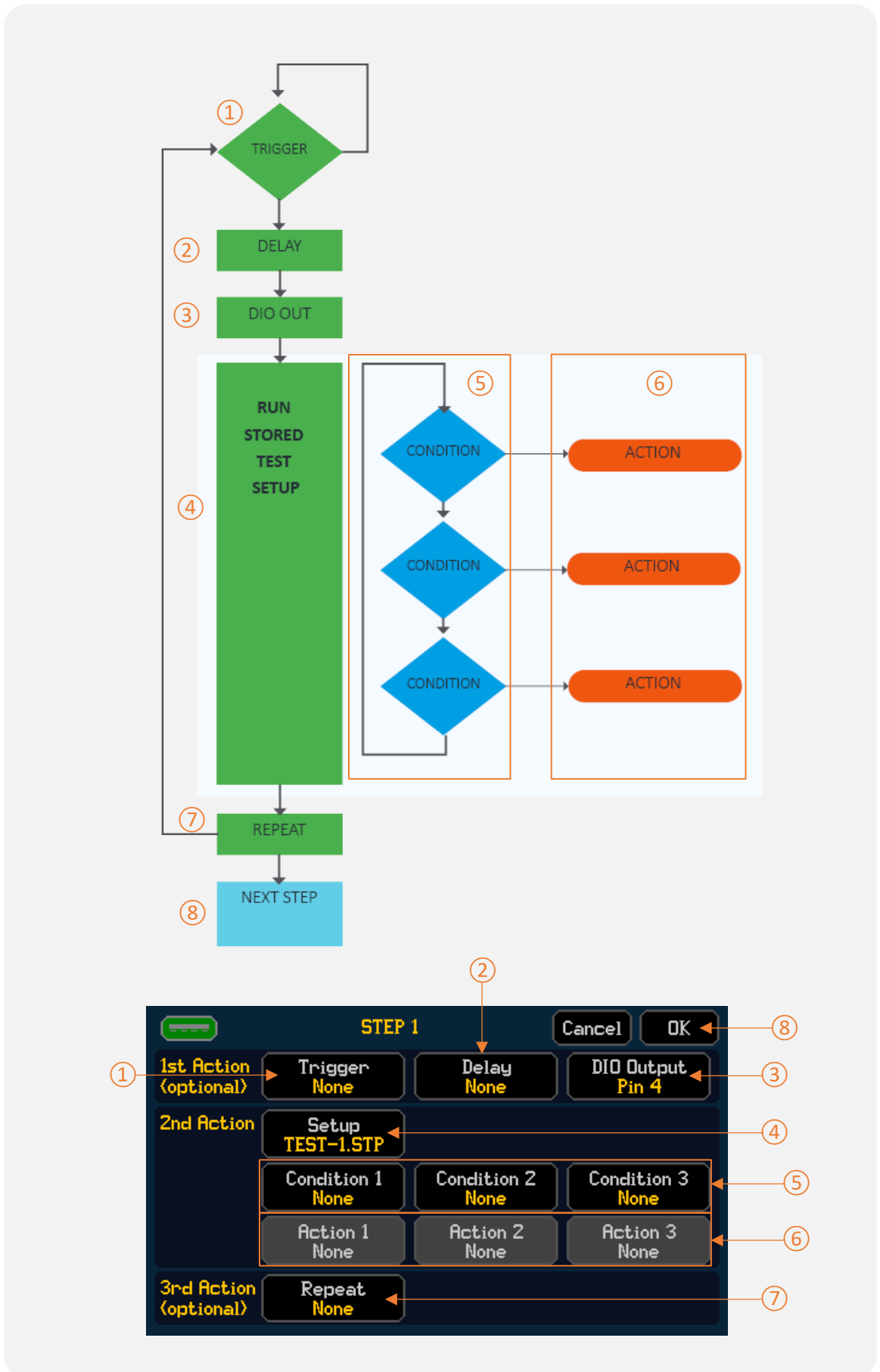

8 - Manual setup

Sequence mode

Sequence Step



Trigger

Setting a trigger will instruct the SMU to wait and monitor for a DIO input signal or remote command to be received to trigger start of the sequence.



Delay

The delay action will set a time delay before starting the sequence, this will occur after the trigger, if set.



DIO Output signal

The SMU will set the assigned DIO output pins to either Logic High [5V] or Logic Low [0V] before the main setup is run. Step 1 can be set High or Low, step 2 onwards can be set to Ignore, High or Low.



Setup

The setup is the main body of the sequence step, a setup (.stp) file must be created prior to creating a step and loaded into the setup menu before any actions or conditions are added to build the step.

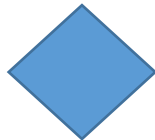

Conditions

Conditions are linked to the loaded setup and measured results, the SMU constantly monitors activity for set conditions, if a condition is met an action will be activated. Up to three conditions can be applied to each step, each condition is assigned a single action.

A condition can be set to the following:

Level- Monitor for a set level(V,A,W, or Ω) including \leq or \geq than a set level, within two set levels or outside of two set levels.

Timeout- Run for a specified period of time.

External Input trigger - Monitor for an external trigger via remote command or DIO.



Actions

Actions are assigned to conditions; any action can be added to any condition, the same action can be used multiple times. The action will activate when the assigned condition is met, if the condition is not met, the action will be ignored.

An action can be set to the following:

Jump to step - Jump to a pre-defined step or next step in the sequence.

DIO output level- Set DIO output pin as Logic High [5V] or Logic low [0V]

Stop – Stop the sequence



Repeat

This will repeat the entire step a set number of times.

8 - Manual setup

Sequence mode

Sequence Setup considerations

The Setup file added to the sequence contains parameters and states that affect the behaviour of the step, occasionally additional considerations are required to ensure that the sequence behaves as expected, this section contains advice on how to avoid potentially unwanted scenarios in a sequence.

Condition priority

The priority of the condition runs in numerical order (1, 2 then 3), if two conditions are met at the same time, the first condition will be actioned over the next. If the action related to the condition is to set a DIO pin, multiple conditions will be executed at once.

Output state between steps

By default, each time a new step is loaded during a running sequence the output will switch off between steps. It is possible to configure a sequence where the output will remain on between steps, for this to happen the mode of operation in the adjacent steps must be the same and the measurement control must be set to **Constant Level**, see '*Measure Control*' for more details.

NOTE



When Measurement control is set to **Constant Level**, **Auto Store** will not generate separate CSV files between steps, measurement data from all steps in the sequence will be stored as a single file.

The off condition of the active step will be applied until the next step is shown as active. It will change accordingly based on the settings in the next active step.

Infinite Measurement count

If the setup is set to record infinite measurements (See '*Measurement count*') the sequence will indefinitely run that in step, unless there is an Action set to stop or move the sequence on when a Condition is met.

Global & Sequence Triggers

Global triggering is applied to the level or shape in a loaded setup in the same way as described in '*Trigger*'.

Sequence mode also provides an external input triggering option, this can be set to any free DIO pin to start a sequence or as a condition.

If triggering via remote command, the commands are as follows:

SYST[em]:TRIG[ger] = Global Trigger within a setup, used to trigger a level or shape.

*TRG = Sequence Trigger can be used to start a sequence, or assigned as a condition to initiate an action.

8 - Manual setup

Sequence mode

Timing

When adding a setup to a sequence, the parameters of that setup will control the timing of the sequence. See 'Timing options' for more details.

When a sequence is running, the SMU checks approximately every 150ms for an event or condition.

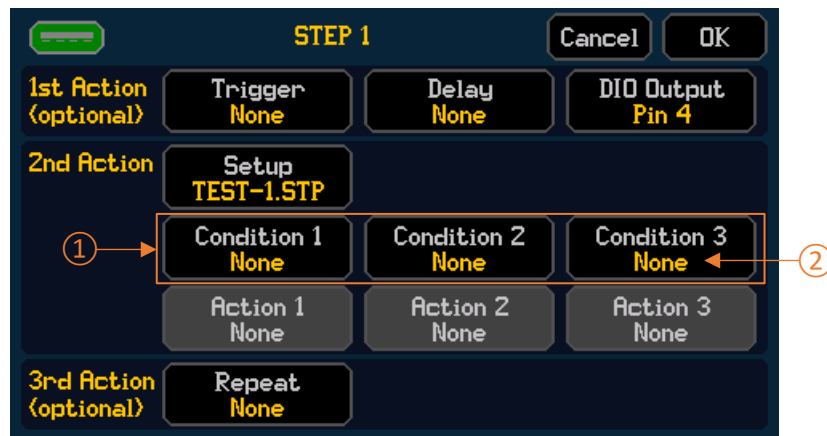

The conditions for the 2nd Action ① are performed/checked in order. For example, if only Condition 3 ③ is set then two cycles (~150ms) will be needed prior checking that condition.

On a jump action after a condition the next step will be enabled after ~150ms.

On repeat, the step will be loaded after ~150ms.

If no conditions are met, the next step will be loaded at the end of the last measurement.

The output will be set to off once the step is complete if it is the final step in the sequence.

If the step contains a list, the time of loading a setup within an active step may be longer dependant on the length of the list. If the list linked to the setup for the selected step is not located in the internal memory, the step will fail and the sequence will be terminated.

The previous timings will be altered if a delay is applied as this value will be added on top of the time between cycles. The output is switched on after the delay is applied.

DIO Logic

Only valid pins will be editable from the DIO Input/output menus. To enable the pin to output or read a value the DIO Configuration must be set first. This can be set in the DIO Configure menu, which can be accessed from the Sequence mode menu screen or the Interface menu. Once pins are assigned as Input or Output, they can be used within the sequence. See 'Digital I/O' for more details.

Input pins

Available pins can be selected, only selected pins will be monitored for their active state.

Output Pins

The SMU will set the assigned DIO output pins to either Logic High [5V] or Logic Low [0V] before the main setup is run. Step 1 can be set High or Low, step 2 onwards can be set to Ignore, High or Low.

8 - Manual setup

Sequence mode

Running a sequence

When running a sequence (pressing the RUN button) the RUN Button LED will illuminate to show the sequence is running, however the output may not be switched on immediately depending on the parameters set in **Action 1**.

For example; If a delay has been added to the start of a sequence, RUN is pressed and the RUN button LED will illuminate. However, the output will stay off until the delay has passed.

When running a sequence, the active step will appear on the home screen. The active step is also highlighted in the sequence model.

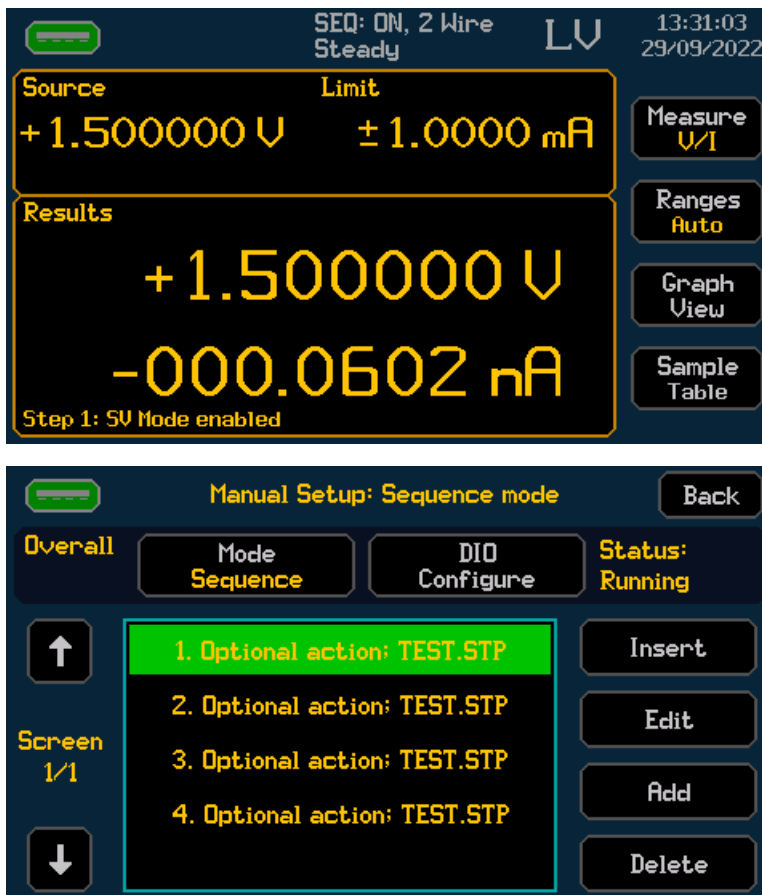

Any trip caused by OVP/OCP/OPP will cause the entire sequence to stop.

If a sequence is interrupted (satisfied stop condition, manually disabling the output or a trip/protection event) a message will appear in the event log.

8 - Manual setup

Sequence mode

Storing a Sequence

Sequences, unlike manual setups, are not stored between power cycles. When power cycling the instrument, the mode will remain as Sequence mode, the sequence model will be empty and require reloading from the setup menu.

Each sequenced model can be stored and recalled to and from the internal non-volatile memory, see *'Storing and Loading Setup Files'* for more details.

Viewing Sequence Measurement Results

All sequence measurements are recorded in the buffer, see *'Saving Data'* for more details.

By default, the CSV generated will contain the measurements for all the steps up to a maximum of 100K steps. The file will contain the step (starting on 0) and the iteration, or repeat, starting on 1.

If **Auto Store** is selected, a CSV file containing the measurements for a single step is generated between steps.

NOTE



If Measurement control is set to **Constant Level**, **Auto Store** will not generate separate CSV files between steps .

Due to the nature of the sequence mode setups, each step can be set to measure different measurement types.

For example, step 1 primary measurement = Voltage, step 2 primary measurement = Current.

The SMU records all Voltage, Current, Resistance & Power measurements in the buffer for each step. The graph will use the primary measurement selected in *'Measurement selection'* to show the results to avoid mixed data on the same axis.

NOTE



The total number of measurements recorded cannot exceed 100,000. The sequence will continue to run when the measurement buffer is full, however no measurements will be recorded.

9. DIGITAL I/O

CNFG > [System] Interfaces > [DIO] Configure

CNFG > [Source Measure Action] Manual Setup > Mode > Sequence Mode > DIO Configure

NOTE



DIO configuration is exclusively for use with sequence mode.

Overview

General

There are five independently configurable digital input/output lines for use with sequence mode. The direction (I/O) of each individual DIO line can be configured when sequence mode is active. Each line can be configured as an Input, Output, or Disabled. The general DIO pins can be used for triggering input and output events from within a sequence, this allows a defined sequence to control or be controlled by external circuitry. Such an application for this may be automated component sorting and binning, or multi-instrument control and triggering.

Aside from the general DIO, there are also additional DIO functionalities.

Global Trigger IN / OUT

The global trigger functionality allows for triggered control of the timing of shape waveforms. The trigger can be utilised to control the stepping through of the points of a shape waveform, in this case an input trigger event is required in order for the source setting to move onto the next level. The input trigger can also be used to repeat shape waveforms, in order to source the next waveform shape. See '*Trigger*' for more details. Once the event has been triggered and all associated measurements to that event have been made, the instrument sets a global trigger output on the DIO port. This combination of global trigger in and trigger out allows for the handshaking of multiple instruments.

SMU Link adaptor

Two SMUs can be linked together via the DIO terminals to perform simultaneously via a handshake triggering system, effectively creating a fully functioning two channel SMU, useful for testing three leaded components such as small signal BJT's, FET's and more.

To make this 'link' far simpler and more convenient to utilize, an 'SMU LINK' adaptor accessory is available. This link adaptor can simply connect to both DIO terminal ports to synchronise the two SMUs together, without the need to wire each DIO terminal individually as required. The adaptor effectively connects the 'Global Trigger In' of each SMU to the 'Global Trigger Out' of the other. The adaptor also provides push terminal access to all DIO port pins of both SMUs to maintain external control where required.

The SMU Link is available from the manufacturers or their agents, see www.aimtti.com for more details.

High Voltage Interlock

This allows for the controlling of the HV interlock via external circuitry. This is primarily designed for helping to ensure the safe operation and safety of users of the equipment when embedded into a test system or test fixture. For safety reasons, test fixtures that may contain hazardous voltages often utilize a safety cover, a form of lid or even complete enclosures to protect the user from hazardous voltage exposure.

9 - Digital I/O

Overview

Installing a switch on any of these and linking to the external DIO interlock control. Allows for the limiting of hazardous voltages (Low voltage operation) whenever the switch is opened. When controlled via the DIO, the High Voltage Interlock works independently from the password protection, when activated or deactivated, password protection is not required to be removed.

DIO Active High /Active Low

Sets all of the DIO pins to be either Active High or Active Low edge triggered logic.

When using the DIO as an output, for active high the resting state will be low and for the active low the resting state will be high.

When using as a input, the resting state is always high (4.7kohm pull-up (internal) to +5V).

Pinout

Pin	Functionality
1	5V (500mA Fused)
2	General DIO
3	General DIO
4	General DIO
5	General DIO
6	General DIO
7	Global Trigger Output
8	Global Trigger Input
9	HV Interlock
10	0V

Additional +5V and 0V lines are provided for powering external control circuitry. The 5V supply is internally fused (resettable fuse) to 500mA, see the SMU4000 Series Service Manual for more information.

Input levels:

Set direction to **Input** to allow an external device to control the state of the line.

Logic Zero (low): -0.25V to +1V (diode clamped to 0V).

Logic One (high): +1.75V to +5.25V (diode clamped to +5V).

Output levels:

Logic zero (low): open-drain MOS, typically 0.2ohm, **100mA maximum sink**.

Logic one (high): nominally 4.7kohm pull-up (internal) to +5V.

Connector Specification

10W (2 x 5 DIL), 2.54mm pitch.

Mates with standard 10W (2 x 5 DIL) female 2.54mm pitch IDC ribbon cable.

10 - Math Functions

Applying calculations to measurements

10. MATH FUNCTIONS

CNFG > [Source Measure Action] Manual Setup > [Results] Math

Applying calculations to measurements

The Math operation menu provides a set of mathematical calculations that can be performed on the primary measurement data. Math operations are applied to the active operating mode. If the mode is changed, only math operations set for that specific mode will be active.

Many of the Math operations require a reference value which can be manually entered or set to the live measurement value, from the Math menu. Once a math function has been selected. The reference value can also be set directly from the sample table or graph, see '*Sample table*' or '*Graph*' for more details. The reference value is assigned per measurement type, per mode.

The active math operation is shown on the home screen.

The operations available are:

Deviation (relative offset)

Displays measured results as a deviation (or relative offset) in relation to the specified reference point.

Measured results = (measurement- reference)

% Deviation

Displays measurement results as a percentage deviation in relation to the specified reference point.

Measured results = $100 \times (\text{measurement} - \text{reference}) / \text{reference}$

When the measurement is less than the reference, the measured result will be shown as a negative value. When the measurement is greater than the reference it will show a positive value.

% Ratio

Displays measurement results as a percentage ratio in relation to the specified reference point.

Measured results = $100 \times \text{measurement} / \text{reference}$

mx+b

Displays measurement results as shown in the following equation:

Measured results = $(m \times \text{measurement}) + b$

m is a user specified multiplier value.

B is an offset value that can either be set as a user specified custom value or a live reference point.

Measure

CNFG > [Source Measure Action] Manual Setup > [Results] Measure

The Math Measure configuration selects which measurement the math operation will be applied to.

11. RESULT SORTING

CNFG > [Source Measure Action] Manual Setup > [Results] Sorting

Tolerance

Tolerance sorting provides pass or fail limit testing using an upper and lower limit to determine the result.

Measurement

The primary and secondary measurements are determined by the Measure function, see '*Measurement selection*' for more details.

To enable a measurement type for tolerance sorting, select **Primary** or **Secondary** and press **On**, the button will now display **Enabled**. The tolerance sorting can be disabled by pressing **Off** whilst the button is selected.

Limits

Measurements made within the set upper and lower limits will display T PASS on the results screen.

If the measurement is above or below the set limit, the results screen will display T FAIL above the relevant measurement result. Pass and fail results will be available to view in the saved .CSV file. See *Saving Data*

12. APPLICATION NOTES

Source- Measure considerations

Stability

Due to their fast and agile output capabilities, source measure units are sensitive to the impact of load characteristics, interconnection inductance and feedback loop characteristics, which can give rise to unexpected instability or poor dynamic behaviour. However, there are key steps that can be taken to help over-come these potential issues.

- Ensure all current carrying output wires (MAIN HI and MAIN LO) are as short and thick as possible.
- Ensure all current carrying output wires (MAIN HI and MAIN LO) are twisted tightly together to minimise loop area.
- Enable high reactance mode.
- Fix voltage and current ranges to a suitable manual selection.
- Be very cautious when utilizing the 200nA and 2 μ A ranges, as these ranges are very sensitive. Try selecting the 20 μ A range instead.
- Reduce the maximum slew rate.
- Reduce all output load inductance and capacitance as much as possible.

Noise Pickup

Due to their high resolution and numerous low level measurement ranges, source measure units are very susceptible to noise pickup. However, there are many things that can be done to help reduce noise pickup issues.

- Always set an integer number of PLCs for the measurement period. Extend the measurement period as long as possible. It's recommended to use at least 50 PLC for the 200nA range.
- Utilize the guard capability. Ensure the guard is kept as close to the Main Hi signal as possible. This can significantly reduce leakage issues.
- When utilizing the 2-wire terminal configuration, ensure the cables are twisted tightly together. Essentially shield the MAIN HI signal with the MAIN LO signal. Alternatively use a 4mm banana to BNC adaptor and use a screened BNC cable instead. Ensure the BNC cable is correctly rated for the voltage and current levels used.
- Where possible try to place the DUT into a shielded enclosure that is connected to MAIN LO.
- Utilize the front panel ground chassis connection as a shield, however this is unlikely to be as effective as the MAIN LO terminal.
- Turn off/ route cables away from any known noise sources within the environment.

12 - Application notes

Source- Measure considerations

Timing

In addition to the timing controls in the manual setup menu, there are other things that can be done to optimise the rise and fall time performance of the SMU.

- Slew rate setting – Ensure slew rate is set to maximum for optimum rise/fall times.
- High Reactance Setting – Ensure high reactance is set to off for optimum rise/fall times.
- Ranges – Always select manual ranges for optimum rise/fall times.
- Load Power level – In modes that utilise the voltage source, higher load levels will result in a slightly slower response.
- Voltage Limit – To reduce the risk of limit overshoot, the current source is slewed slightly based upon the voltage limit set. The voltage limit can be increased to reduce the amount of slew applied.
- Current Limit – To reduce the risk of limit overshoot, the voltage source is slewed slightly based upon the current limit set. The current limit can be increased to reduce the amount of slew applied. Note that a greater slew is applied on limits <210mV, i.e., the 200mV and 20mV ranges.
- Load reactance – Any load capacitance or inductance can have significant effects on the output response, potentially affecting both speed and overshoot.
- High voltage polarity reversal – When the output is changed from a level <-21V to >+21V or >+21V to <-21V a delay of around 280ms must be incorporated.
- Setting a limit too close to the desired output level can result in extended source rise/fall times. The source is slewed slightly when approaching (and predicting to exceed a limit) in order to enter the limit smoothly.

12 - Application notes

PowerFlex

PowerFlex

The PowerFlex system provides a semi constant power characteristic so that the current capability rises as the voltage falls.

PowerFlex technology enables the instrument to achieve full instrument output power across the majority of the voltage range.

NOTE



The power is limited by the 3A current limit at absolute voltages $< |8.33V|$.

The output current is limited to 0.5A at absolute voltages $> |21V|$.

Absolute voltages above $|21V|$ are only achievable on the SMU4201.

Maximum Voltage and Current capabilities:

SMU4001 & SMU4201 0V to 20V	
Voltage(±)	Current(±)
5V	3A
8V	3A
10V	2.5A
12V	2.08A
20V	1.25A

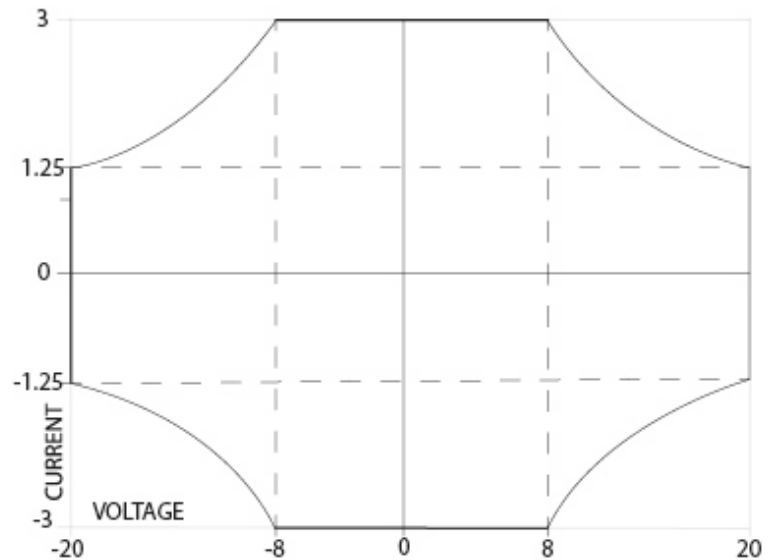

SMU4201 21V to 200V	
Voltage(±)	Current(±)
21V	0.5A
50V	0.5A
100V	0.25A
120V	0.208A
150V	0.167A
180V	0.139A
200V	0.125A

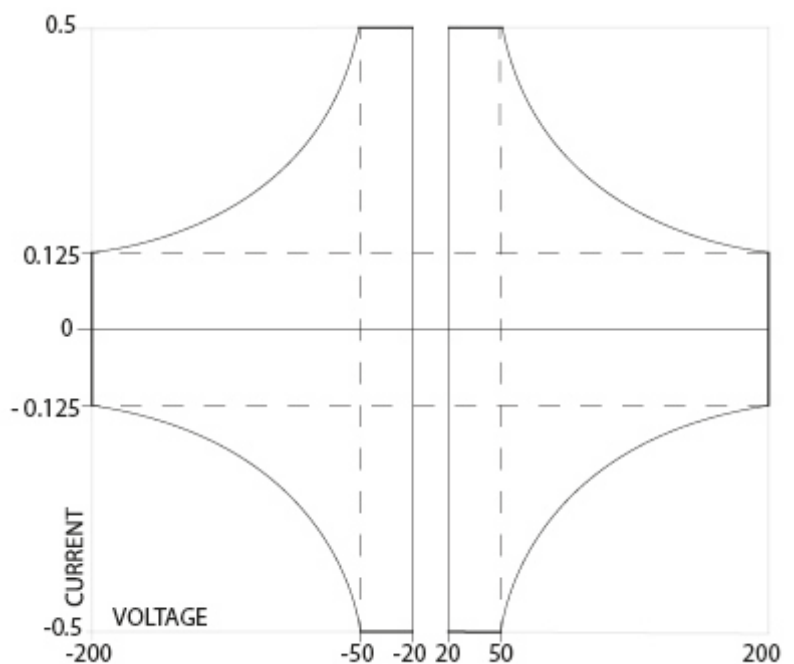

13. SYSTEM MANAGEMENT

CNFG > [System] Manage

The System management menu provides general instrument management settings and information.

This includes security with password protection, display and audible settings, environmental and firmware upgrade options.

This menu also displays general information about the instrument including its serial number, firmware versions and last calibration date.

Security

Password protection

Any changes to the level of protection applied will require the password to be entered.

NOTE



The default password is: 123456 Once entered correctly this password can be changed. If the new password is forgotten, a master password is available in the service guide – available upon request.

- Off- No password protection applied to any settings.
- HV LV Setting [SMU4201 only]- Password protection applied to restrict access to voltages $\pm 42V$ via the High Voltage Interlock, see '*High Voltage Interlock* [SMU4201 only] for more details (Default).
- S/M Settings - Restricted access for all Source and Measurement settings. This includes any changes to the settings within the **Source Measure Action** ① menu.
- All Settings - Restricted access to all Configuration settings. This includes any changes to the **Source Measure Action** ① and **System** ② menus.



13 - System management

PowerFlex

How to change the password

CNFG > [System] Manage> [Security] Change Password

In the Change Password menu, enter the existing password (if this has not been changed before, the password will be 123456).

Press OK to confirm, followed by the new password – a minimum of 1 and maximum of 6 digits are permitted. Press OK to confirm.

Display

Brightness- settable from 0-100%

NOTE



0% brightness will set to the minimum useable brightness; the display will always be visible.

Auto Dim

User configurable dimming function; dims the display to 0% brightness after a specified duration.

- Off – Disabled (Default)
- Slow- Display will dim after 1 hour of inactivity.
- Normal- Display will dim after 20 minutes of inactivity.
- Fast- Display will dim after 5 minutes of inactivity.

Beeper

Beeper will sound in specified scenarios.

- On- Beeper is active for key presses, warning, and notifications.
- Errors- Beeper is active for warnings only.
- Off- Beeper is disabled (Default)

Environment

Power Control

The power to the instrument will perform in a pre-configured way.

- Manual On/ Off- Whilst AC mains in connected, the standby switch will alternate between powering the instrument on and off (normal operation).
- Initially On- Immediately powers the instrument on when the AC mains in connected, manual power control will remain functional after the initial power on.
- Always On- Whilst AC mains is connected, the standby switch will perform a reset when pressed.

13 - System management

PowerFlex

Air vents

The fan speed is dynamically controlled and based on many factors, including internal sensed temperatures, measured current and measured power. However, if there is reason to suggest that the air vents are restricted in any way then the fan speed algorithm can be adjusted to help compensate for this.

- Clear- Normal fan speed.
- Restricted- Fan speed increased to compensate for the restriction.

Wherever possible always make sure the air vents are not restricted in any way. However, this can be difficult when rack mounted, in which case ensure the setting is set to Restricted. If the restriction is too great and the fan cannot deal with the excess temperatures, it is likely that an undesired internal temperature trip will occur to prevent damage to the instrument.

Firmware update

Latest Firmware updates can be found at www.aimtti.co.uk/support

To update the firmware:

- Download the latest version of the SMU firmware from the website. (This is compatible for both 4001/4201 models).
- Unzip the compressed file.
- In the extracted folder you will find another folder called "UPDATE". Copy the folder to the root of a FAT32 formatted USB flash drive.
- Insert the USB flash drive in the SMU, the top left icon will turn green.
- Navigate to: CNFG > [System] Manage> [Environment & Upgrade] Firmware Update
- A pop up will appear asking you to confirm the action, press OK to confirm .
- The firmware update will begin, during the update the unit will restart multiple times.
- Once completed, the Home screen will appear alongside a message to confirm the unit has upgraded successfully.
- The USB flash drive can now be removed.

CAUTION



Do not delete or change any of the files inside the "UPDATE" folder prior to a firmware update.

Configuration & Info

Default settings- sets all configuration data to default, see '*Factory Default settings*' for more details.

System Info- Displays the Manufacturer, Model, Serial number, Firmware Version numbers and calibration status.

13 - System management

PowerFlex

Date and Time

The Date and time are used when recording measurement data in the sample table and exported .csv files. It is shown on the status bar on the Home screen and can be edited by selecting the field, which will open an editing menu. Whilst in the menu, the Date and Time will stay as is currently set and will only change if the OK key is pressed. If the Cancel button is pressed, no changes will be made. The format can be changed by selecting the specified format button for either Date or Time. The following formats are available:

24 Hour clock (Default)

12 Hour clock

DD/MM/YYYY (Default)

MM/DD/YYYY

YYYY/MM/DD

NOTE



The date format in an exported .csv file will always be YYYY/MM/DD

Recovery mode

The recovery mode can be used in cases where a corrupted firmware update has been performed and/or the unit cannot switch on in normal functional mode. In this mode the firmware can be updated as needed to recover the SMU.

To put the SMU into recovery mode, hold the HOME key and press the standby button (when the SMU is powered OFF) until recovery mode is enabled.

To exit recovery mode, switch off the instrument in the usual way using the standby button.

14 - Maintenance

Cleaning

14. MAINTENANCE

The manufacturers or their agents will provide a repair service for any unit developing a fault. Where owners wish to undertake their own maintenance work, this should only be done by skilled personnel in conjunction with the service guide which may be obtained directly from the Manufacturers or their agents.

Cleaning

If the instrument requires cleaning, use a cloth that is only lightly dampened with water or a mild detergent.

WARNING



To avoid electric shock, or damage to the instrument, never allow water to get inside the case.
To avoid damage to the case never clean with solvents.

15. REMOTE INTERFACES

Overview

The Interfaces menu contains configuration options for the digital remote interfaces.

This includes configuration options for LAN, USB and GPIB (where fitted).

This menu also provides the status information of any of the digital remote interfaces that are connected to the instrument.

For more information on Remote Interface configuration, see 'SMU4000 Series Programming Manual', available to download from www.aimtti.com/support

16 - Calibration

Measurement Zero and Self Calibration

16. CALIBRATION

Measurement Zero and Self Calibration

An automatic zero calibration and self calibration is performed every time that the instrument is switched on.

However, if the instrument has been stored at a temperature outside the specified operating range, and is switched on before it has fully acclimatised to the working environment, accuracy may be affected as the meter's temperature changes.

To ensure optimum accuracy, particularly on the lower current and voltage ranges, zero calibration can be repeated when the meter has acclimatised by using the TEST key on the front panel.

NOTE



It is recommended that the self test is performed after 1 hour warm up or before acquiring measurements for highly accurate tests .

Routine Calibration

The Calibration menu provides access to all of the instrument calibration routines.

The external calibration routines require accurate measurement equipment for measuring ultra-precise DC voltages and currents.

This menu is password protected; the password can be found in the SMU4000 Series Service Guide, available upon request from www.aimtti.com/support

WARNING



Routine Calibration should only be carried out by qualified service personnel. Some of the calibration procedures may expose the service personnel to hazardous voltages.

17 - Factory Default settings

Routine Calibration

17. FACTORY DEFAULT SETTINGS

Manual Setup

Mode	SV Mode (Source Voltage)
Terminals	2 Wire
Shape	Steady
Source Level	1V
Current Limit	100mA
Measurement Count	Infinite
Primary Measurement	Voltage
Secondary Measurement	Current
Delay	Auto
Measurement Period	1PLC
Voltage Range	Auto
Auto-Minimum Voltage Range	20mV
Current Range	Auto
Auto-Minimum Current Range	200nA
Off State	0V/100 μ A
Off State Measurements	Off
Slew Rate	Max
High Reactance	Off
Measurement Control	Off
OCP	Disabled
OVP	Disabled
OPP	Disabled
Math	None
Sorting	None

Graph

Type	YT Graph
Style	Line
X Axis Minimum Position	0 Seconds
Y Axis Minimum Position	0V
X Axis Scale	200 μ s/div
Y Axis Scale	20nV/div
Markers	Disabled

17 - Factory Default settings

Routine Calibration

System

High Voltage Interlock *

LV

Brightness

75%

Auto-Dim

Off

Beeper

Off

Power Control

Manual On/Off

Air Vents

Clear

*SMU4201 only

18 - Specification

Specification Conditions

18. SPECIFICATION

Specification Conditions

Settling Time and Accuracy specifications are valid after a minimum of 60 minutes warm-up followed by self-calibration execution and measurement zero. Ambient temperature change of less than $\pm 3^{\circ}\text{C}$ after self-calibration and measurement zero.

Calibration Period: 1 Year
Temperature: $23^{\circ}\text{C} \pm 5^{\circ}\text{C}$
Measurement Period: ≥ 10 PLC

Key Specifications of SMU4000 series

	SMU4001	SMU4201
Maximum Voltage	$\pm 21\text{V}$	$\pm 210\text{V}$
Voltage ranges	20mV – 20V	20mV – 200V

Operating Modes

Source Voltage (SV), Source Current (SC), Load Current (LC), Load Resistance (LR), Load Power (LP), Measure Voltage (MV), Measure Current (MC), Measure Resistance (MR), Measure High Resistance (MHR), Sequence.

Voltage Measurements (all modes except MC)

Range	Resolution	Accuracy (%reading + offset)
20mV	10nV	$\pm 0.06\% \text{rdg} \pm 50\mu\text{V}$
200mV	100nV	$\pm 0.015\% \text{rdg} \pm 50\mu\text{V}$
2V	1uV	$\pm 0.015\% \text{rdg} \pm 50\mu\text{V}$
20V	10uV	$\pm 0.02\% \text{rdg} \pm 5\text{mV}$
200V ¹	100uV	$\pm 0.02\% \text{rdg} \pm 5\text{mV}$

¹200V range only available on SMU4201

Current Measurements (all modes except MV)

Range	Resolution	Accuracy (%reading + offset)
200nA ²	100fA	$\pm 0.04\% \text{rdg} \pm 300\text{pA}$
2uA	1pA	$\pm 0.03\% \text{rdg} \pm 300\text{pA}$
20uA	10pA	$\pm 0.02\% \text{rdg} \pm 2\text{nA}$
200uA	100pA	$\pm 0.02\% \text{rdg} \pm 2\text{nA}$
2mA	1nA	$\pm 0.02\% \text{rdg} \pm 200\text{nA}$
20mA	10nA	$\pm 0.02\% \text{rdg} \pm 2\mu\text{A}$
200mA	100nA	$\pm 0.02\% \text{rdg} \pm 20\mu\text{A}$
1A	1uA	$\pm 0.07\% \text{rdg} \pm 100\mu\text{A}$
3A ³	1uA	$\pm 0.2\% \text{rdg} \pm 300\mu\text{A}$

²Typical Accuracy

³Only available by Manual range selection when in modes that utilize the current source

18 - Specification

Key Specifications of SMU4000 series

Measurement Supplementary Characteristics

Measurement Period	User settable 200µs to 20s (10µs resolution), or 0.01 to 100PLC (0.001PLC resolution) If set to integer PLC: synchronized to actual mains supply period Accuracy: ± (50µs + 0.01%) Typically, <±0.5µs delay between measured Voltage and Current signal measurements	
Temperature coefficient (5° – 18°C and 28° – 40°C)	± (0.15 x accuracy spec) / °C	
Burden	Voltage Measurement	>10GΩ ±80pA
	Current Measurement	4-wire sense: <±100µV 2-wire sense (front terminals): <0.16Ω 2-wire sense (rear terminals): <0.08Ω
External Guard offset Voltage	<±100µV from SENSE or MAIN HI terminal	
4-wire Sense Capability	Up to ±2V between respective MAIN and SENSE Terminals	

Resistance Measurements (all modes except MV and MC)

Resistance is internally calculated from measured Voltage and Current.

Resistance errors (in Ohms) may be calculated from respective voltage and current measurement results and specified errors as follows –

$$(\text{Current} * \text{Voltage error} + \text{Voltage} * \text{Current error}) / \text{Current}^2$$

Where Voltage is the Voltage reading in Volts (without polarity)

Voltage error is the specified Voltage measurement error in Volts

Current is the Current reading in Amps (without polarity)

Current error is the specified Current measurement error in Amps

Power Measurements (all modes except MV and MC)

Power is internally calculated from measured Voltage and Current.

Power errors (in Watts) may be calculated from respective voltage and current measurement results and specified errors as follows –

$$(\text{Current} * \text{Voltage error} + \text{Voltage} * \text{Current error} + \text{Voltage error} * \text{Current error})$$

Where Voltage is the Voltage reading in Volts (without polarity)

Voltage error is the respective specified Voltage error in Volts

Current is the Current reading in Amps (without polarity)

Current error is the respective specified Current error in Amps

18 - Specification

Key Specifications of SMU4000 series

Voltage Source (SV and MHR modes)

Accuracy	Same as voltage measurement accuracy	
Source Limit ⁴	SMU4001	±21V
	SMU4201	±210V
Maximum Slew Rate	SMU4001	User settable 21V/s to 120V/ms
	SMU4201	User settable 210V/s to 1.2V/μs
Settling Time (typical)	To reach within 0.5% of change, open load, max slew rate, manual ranges, High Reactance disabled	
	300μs	
	Maximum current limit slew applied equivalent to: 1μV/us per 1nA current limit setting.	
	SMU4201 only	Add 250ms if changing from (>+21V to <-21V) or (<-21V to >+21V) (polarity reversal)
Output Impedance (typical)	<10μΩ (4-wire, steady state)	
Overshoot (typical)	<0.5% + 1mV (resistive load)	
High Reactance Load Stability	Disabled	0 to 0.2μF
	Enabled	>0.2μF to 200μF typical (inductive loading is also accommodated)

⁴ Limits include 105% overrange

Current Source or Load (SC, LC, LR, LP and MR modes)

Accuracy	Same as current measurement accuracy	
Source Limit	SC, MR modes	±3.15A
	LC mode	3.15A
	LR mode	100mΩ to 250MΩ
	LP mode	26.25W
Maximum Slew Rate	SC, LC, LR, MR modes	User settable 3A/s to 36mA/μs
	LP mode	User settable 25W/s to 0.25W/μs
Settling Time (typical)	To reach within 0.5% + 1nA of change, shorted load, max slew rate, manual ranges, High Reactance disabled	
	200nA, 2μA, 20μA, 200μA ranges	2.5ms
	2mA range	600μs
	20mA, 200mA, 1A, 3A ranges	200μs
	SMU4201 Only	Add 250ms if changing from (>+21V to <-21V) or (<-21V to >+21V) (polarity reversal)
Overshoot (typical)	<0.5% + 10nA (shorted load)	

18 - Specification

Output Power, Voltage and Current Capability

Source Supplementary Characteristics

Temperature coefficient (5° – 18°C and 28° – 40°C)	± (0.15 x accuracy spec) / °C	
Output power	25W four quadrant source or sink operation	
Overrange	105% of source and measure range	
Voltage Limits (compliance)	Bipolar limit with single setting Maximum includes 105% overrange Minimum is 10% of selected manual range Accuracy same as voltage measurement 5 digit Resolution	
	SMU4001	User settable 2mV to 21V
	SMU4201	User settable 2mV to 210V
Current Limits (compliance)	Bipolar limit with single setting User settable 20nA to 3.15A Maximum includes 105% overrange Minimum is 10% of selected manual range Accuracy same as current measurement 5 digit Resolution	
	Accuracy same as voltage measurements ±1 digit 5 digit Resolution (100µV fixed) 5% Hysteresis (1mV minimum) Only available in load modes (LC, LP, LR) Voltage range forced to auto in load modes	
	SMU4001	User settable up to 21V
Voltage Dropout (load modes)	SMU4201	User settable up to 210V
	Pulse Width	
Wideband Noise (Voltage source)	User settable 200µs minimum with 10µs resolution	
	SMU4001	<2mV (RMS, 10Hz – 20MHz) typical into a resistive load
	SMU4201	<21V: <2mV (RMS, 10Hz – 20MHz) 21V to 210V: <3.5mV (RMS, 10Hz – 20MHz) typical into a resistive load
Source Settling Time Delay	User settable 100µs minimum with 10µs resolution	

Output Power, Voltage and Current Capability

PowerFlex

PowerFlex technology enables the instrument to achieve full instrument output power across the majority of the voltage range. 3A current limit, limits power at absolute voltages < |8.33V|. Absolute voltages above |21V| are only achievable on the SMU4201. Output current limited to 0.5A at absolute voltages > |21V|.

18 - Specification

Protection

Protection

Over Current Protection (OCP)	Bipolar protection limit with single setting User settable 10 μ A to 3.15A Accuracy same as current measurements ± 1 digit Or can be disabled 5 digit Resolution Setting independent of current range	
Over Voltage Protection (OVP)	Bipolar protection limit with single setting Accuracy same as voltage measurements ± 1 digit Or can be disabled 5 digit Resolution Setting independent of voltage range	
	SMU4001	User settable 10mV to 21V
	SMU4201	User settable 10mV to 210V
Over Power Protection (OPP)	Bipolar protection limit with single setting User settable 1 μ W to 26.25W Accuracy same as power measurements ± 3 digits Or can be disabled 5 digit Resolution	
Over Temperature Protection (OTP)	Internal Temperature safety trip Not user settable, cannot be disabled	
Trip Delay (typical)	$\leq 200\mu$ s	
Trip Status	Output is disabled, off condition is set to OPEN.	

Measurement Result Buffer

Contents (each entry)	Index Primary Measurement Secondary Measurement Date Time (1 second resolution)
.CSV file contents	Index Active Mode Output state Measurement results (V and A) Calculated results (R and W) System Date System Time Measurement Timestamp Sequence Mode Step and Iteration
Length	Maximum of 100000 entries, FIFO style

18 - Specification

Digital Input/Output (DIO)

Digital Input/Output (DIO)

Signals	5 user definable signal pins HV interlock (SMU4201 only) Global Trigger In Global Trigger out (self-resetting based on trigger input) Ground and +5V (fuse limited to 500mA)	
Voltage Reference	Chassis ground referenced	
Input Levels	Logic zero:	-0.25V to +1V (diode clamped to 0V)
	Logic one:	+1.75V to +5.25V (diode clamped to +5V)
Output Levels	Logic zero:	open-drain MOS, typically 0.2ohm, 100mA maximum sink
	Logic one:	nominally 4.7kohm pull-up to +5V
Logic	Active High / Low global port selection	

Remote Control Interfaces

LAN	Ethernet 100/10 base-T hardware connection.
LXI Conformance	1.5 LXI Device Specification 2016
USB	Standard USB 2.0 hardware connection. Operates as a virtual COM port.
GPB (optional)	Conforming with IEEE488.1 and IEEE488.2
Remote Command Processing Time	Typically < 5ms between receiving the command terminator for an output change at the instrument and the output beginning to change.

System Speeds

Measure to Memory	Up to 5k/s sustained
-------------------	----------------------

18 - Specification

Environmental

Environmental

Operating Range	+5°C to +40°C, 30% to 80% RH non-condensing
Operating Mains	220V-240V or 110V-120V AC ±10%, 50/60Hz, by internal selection; 150VA maximum demand Installation Category II
Environmental	Indoor use at altitudes up to 2000m, Pollution Degree 2
Storage Range	-20°C to +60°C, 10% to 90% RH non-condensing
EMC	EN61326-1 and EN61326-2-1, group 1, class A
Safety	EN61010-1 and EN61010-2-030 (uncategorized measurements) MAIN and SENSE terminals rated for voltages up to 210V to ground and between terminals Front panel CHASSIS terminal intended for ground reference purposes only
Security	Kensington security slot incorporated

Mechanical

Size (nominal)	Bench Use: 250mm(W) x 97mm(H) x 295mm(D) Rack Mount: 213.5mm(W) (½ rack) x 86.5mm(H) (2U) x 269mm(D)
Weight (nominal)	4.25kg

Aim & Thurlby Thandar Instruments Ltd. operates a policy of continuous development and reserves the right to alter specifications without prior notice

EXCELLENCE THROUGH EXPERIENCE

Aim-TTi is the trading name of Thurlby Thandar Instruments Ltd. (TTi), one of Europe's leading manufacturers of test and measurement instruments.

The company has wide experience in the design and manufacture of advanced test instruments and power supplies built up over more than thirty years.

The company is based in the United Kingdom, and all products are built at the main facility in Huntingdon, close to the famous university city of Cambridge.

TRACEABLE QUALITY SYSTEMS

TTi is an ISO9001 registered company operating fully traceable quality systems for all processes from design through to final calibration.



ISO9001:2015

Certificate number FM 20695

WHERE TO BUY AIM-TTI PRODUCTS

Aim-TTi products are widely available from a network of distributors and agents in more than sixty countries across the world.

To find your local distributor, please visit our website which provides full contact details.



Designed and built in Europe by:



Thurlby Thandar Instruments Ltd.

Glebe Road, Huntingdon, Cambridgeshire.

PE29 7DR United Kingdom

Tel: +44 (0)1480 412451 Fax: +44 (0)1480 450409

Email: sales@aimtti.com Web: www.aimtti.co.uk

48591-1350 - 01