

# GRAPHTEC

## data LOGGER GL260

Compact Standalone Data Logger

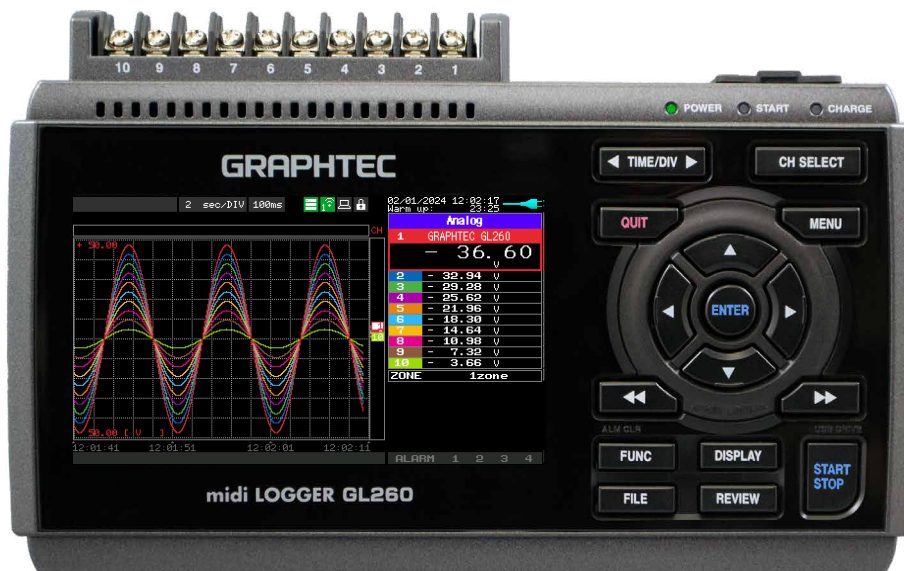

More intuitive operation than ever before  
 Handy and practical data logger

# TABLE OF CONTENT

<b>1. Overview / Features</b>	<b>3</b>
<b>2. Improved operability and new functions</b>	<b>10</b>
<b>3. Software</b>	<b>15</b>
<b>4. Other functions</b>	<b>18</b>
<b>5. Options/Specifications</b>	<b>30</b>

# 1. Overview / Features

<b>About GL260</b>	<b>4</b>
<b>G-REMOTE</b>	<b>5</b>
<b>Alarm history function</b>	<b>7</b>
<b>Inter-CH operation function</b>	<b>8</b>
<b>Memory loop function</b>	<b>9</b>

# About GL260

GL260 is a 10-channel type data logger that supports all channel isolated and multi-function input. It can measure various phenomena such as voltage and temperature.

It operates recording at intervals of 10ms to 1 hour.

Also an optional Wireless LAN unit enables wireless measurement and remote monitoring.

GL260 supports the new Remote control service "G-REMOTE", which makes your measuring more efficient.

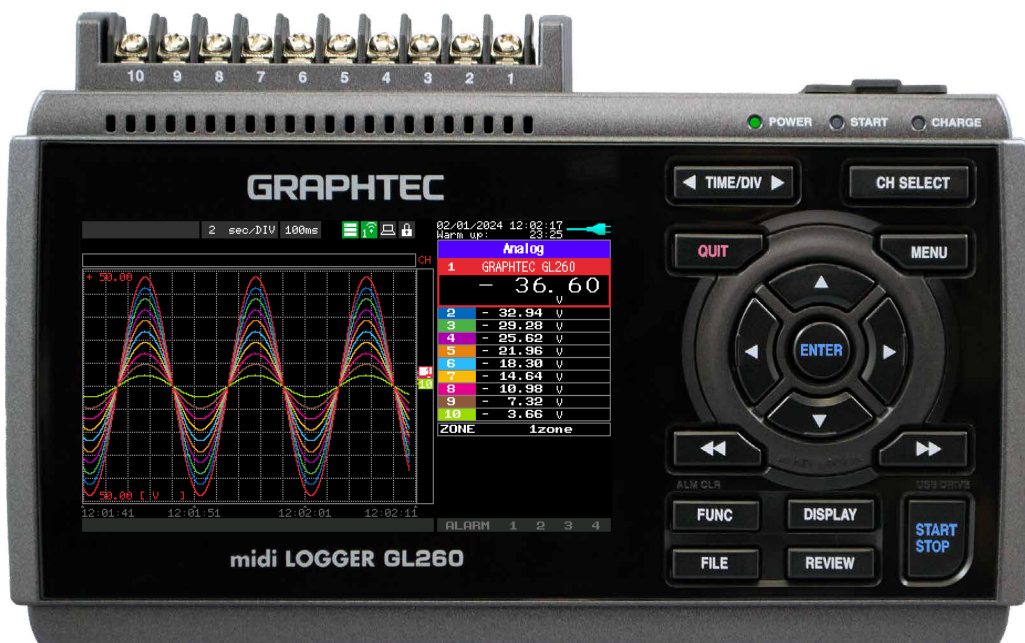

# G-REMOTE<sup>NEW!</sup>

## Remote control & Data storage service

\*Additional fees required.

Remote control and the data recording becomes easier by using web browser from anywhere you have an internet connection.

The recorded data can be backed up to a dedicated cloud server.



### Get services just when and as much as you need

You can purchase the right plan at the right time.

Plan	Free trial	Basic	Standard	Premium
Price	FREE	1 unit monitoring	Max. 5 units monitoring	Max. 10 units monitoring
Preiod of Use	30 days	360 days	360 days	360 days
Storage capacity	1GB	1GB	5GB	10GB

# G-REMOTE

## Remote control & Data storage service

\*Additional fees required.

### Remote control service

- GL remote control via web browser
- Simple user interface
- Easy setup (same menu design as GL260)
- All communications are encrypted



Remote display

### New functions \*Available for all plans

#### CSV replay

Play the data recorded in CSV files

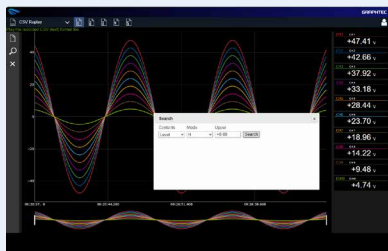

#### Download Timer

Transfer data automatically from GL260 to PC at specified time

### Data storage service

- Backup of recording data
- Upload and share the data
- Destination of FTP backup function

Selected folder /	File name	Capacity	Created time	Deleted	Download	Number of changes
[-] Desktop	20240410-105410					
[-] Desktop	20240410-105358					
[-] Desktop	20240410-105349					

### 3 New functions of GL260

# 1. Alarm history function

## Alarm occurrence/clearing time <sup>NEW!</sup> and event occurrence channel are clear at glance

This function displays a list of the time history of alarm occurrence/clearing.

```

Rec to Int Mem
===== Alarm history =====
1: 11/14/2023 13:10:57 Occur CH4
2: 11/14/2023 13:10:57 Occur CH2
3: 11/14/2023 13:10:58 Occur CH1
4: 11/14/2023 13:10:58 Occur CH3
5: 11/14/2023 13:11:02 Clear CH1
6: 11/14/2023 13:11:02 Clear CH3
7: 11/14/2023 13:11:03 Clear CH2
8: 11/14/2023 13:11:03 Clear CH4
9: 11/14/2023 13:11:07 Occur CH4
10: 11/14/2023 13:11:07 Occur CH2

[<]Previous ( 1/ 3) Next [>] [FUNC]
[<<]Top End[>>] Filter settings
  
```

Alarms can be checked while data is being recorded, allowing the user to look them back later.

## Stores occurrence and clearing history in text data

The file is saved in GAH (Graphtec Alarm History) format and can be opened as a text file.

```

111423-131054.GAH - Notepad
File Edit Format View Help
Vendor,"GRAPHTEC Corporation"
Model,"GL260"
Version,"1.00"
Suffix,""
Number, Data position, Date, Time, CH, Flag, Remarks
1,7888,2023/11/14,13:24:02,CH1,4,"Clear CH1"
2,7888,2023/11/14,13:24:02,CH3,4,"Clear CH3"
3,7896,2023/11/14,13:24:03,CH2,4,"Clear CH2"
4,7897,2023/11/14,13:24:03,CH4,4,"Clear CH4"
5,7937,2023/11/14,13:24:07,CH4,1,"Occur CH4"
6,7938,2023/11/14,13:24:07,CH2,1,"Occur CH2"
7,7945,2023/11/14,13:24:08,CH1,1,"Occur CH1"
8,7946,2023/11/14,13:24:08,CH3,1,"Occur CH3"
9,7988,2023/11/14,13:24:12,CH1,4,"Clear CH1"
10,7988,2023/11/14,13:24:12,CH3,4,"Clear CH3"
11,7996,2023/11/14,13:24:13,CH2,4,"Clear CH2"
12,7997,2023/11/14,13:24:13,CH4,4,"Clear CH4"
13,8037,2023/11/14,13:24:17,CH4,1,"Occur CH4"
14,8038,2023/11/14,13:24:17,CH2,1,"Occur CH2"
15,8045,2023/11/14,13:24:18,CH1,1,"Occur CH1"
16,8046,2023/11/14,13:24:18,CH3,1,"Occur CH3"
17,8088,2023/11/14,13:24:22,CH1,4,"Clear CH1"
18,8088,2023/11/14,13:24:22,CH3,4,"Clear CH3"
19,8096,2023/11/14,13:24:23,CH2,4,"Clear CH2"
  
```



## 2. Inter-CH operation function

More extensive Inter-CH operation function than ever before <sup>NEW!</sup>

Inter-CH operation function

Function to perform four arithmetic operations between two CHs  
(e.g. record CH1 + CH2 = X)

### 10 virtual channels for calculation

➔ No analog CH occupied or overwritten by calculation

### Coefficients can now be used in calculations

➔ More advanced calculations are now possible

### Calculation method can be selected from calculation formula and 4-point input

- Calculation formula: Advanced calculations using coefficients and digit adjustments
- The 4-point input: Temperature slope calculation output

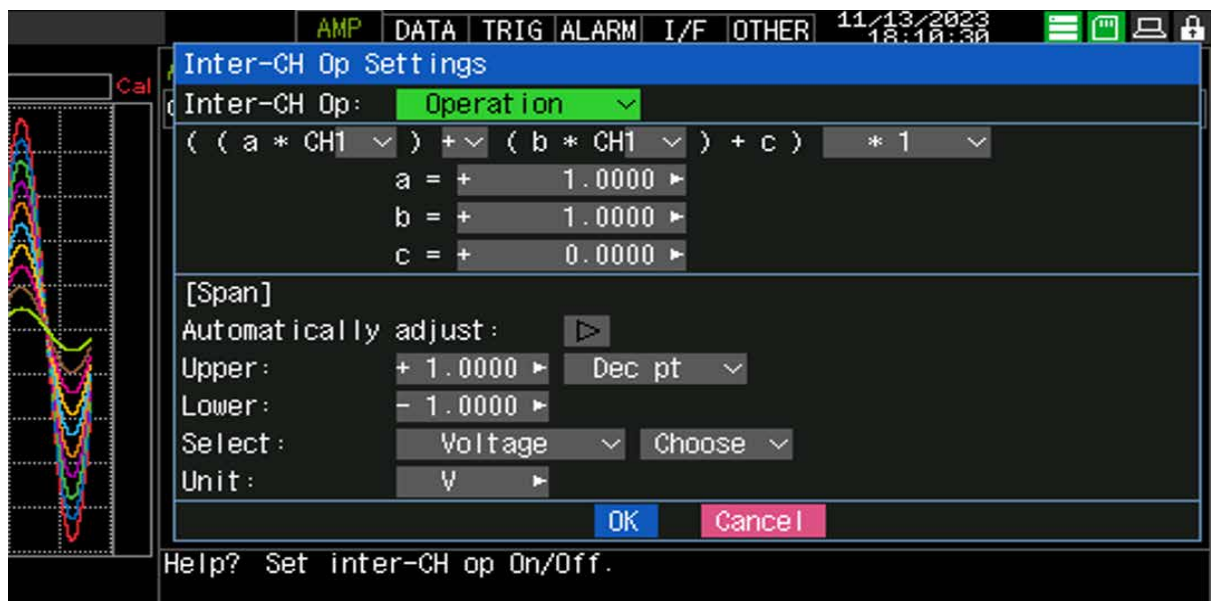



# 3. Memory loop function

## Relay capturing function enables capturing <sup>NEW!</sup> without missing data

In addition to the existing relay function, the oldest file is automatically deleted before memory capacity runs out.

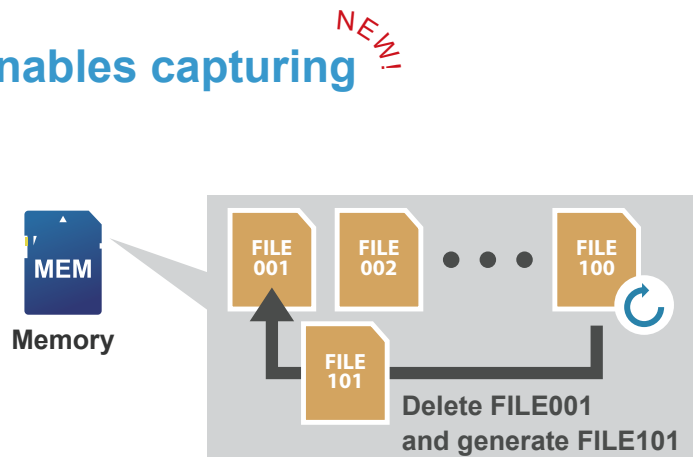

## Other capturing functions (existing functions)

### Relay capturing function

Set the capacity or capturing time of one file, and create a new file when either of them is reached.

Capturing will stop when the memory capacity is full.

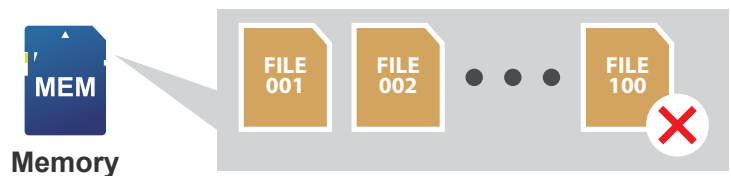

### Ring capturing function

The capacity of one file and the number of data points are set, and when either is full, the old data is deleted and capturing continues.

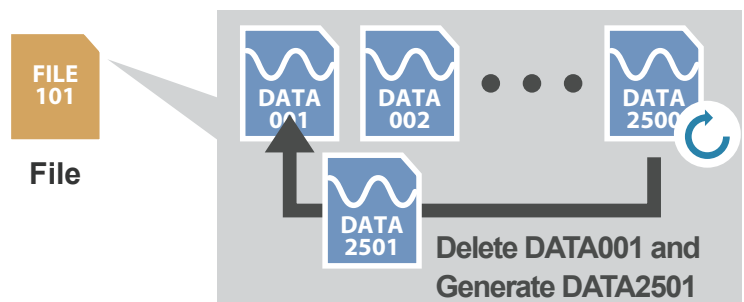

### Regular capturing

Stops when the file size reaches 2GB.

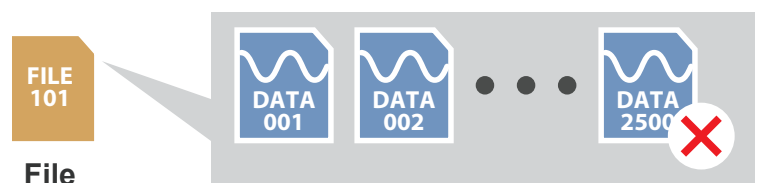

## 2. Improved operability and new functions

<b>Web server function is accelerated</b>	<b>11</b>
<b>Simplified waveform setup</b>	<b>12</b>
<b>Hide unnecessary menus</b>	<b>13</b>
<b>HELP QR Code Display</b>	<b>14</b>

# Web server function is accelerated

## Functional Improvements

### Web server function

This function allows the GL unit settings and measurement values to be monitored using a web browser within the local network.

Easy to set up and control via PC without installing software.

### Faster and smoother processing of update speeds

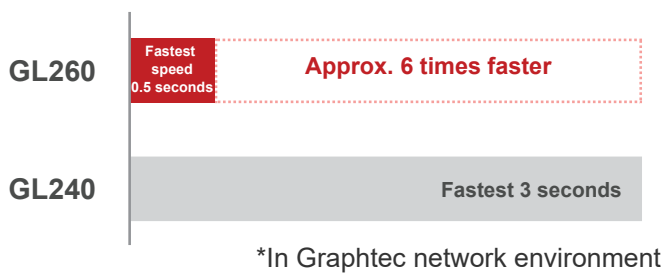

### New User Interface

Same design as GL260 for easier use

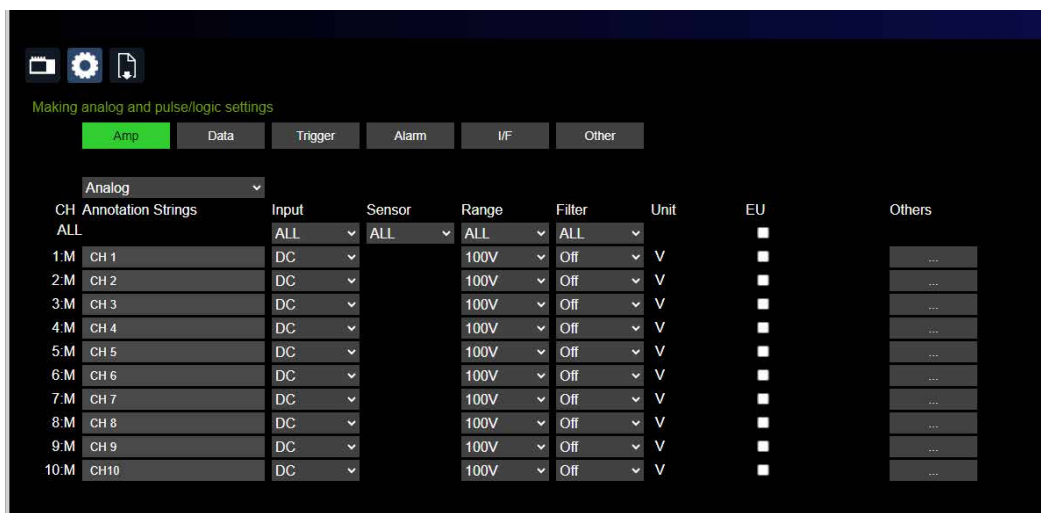

# Simplified waveform setup

## Functional improvement

**One-touch access to waveform setting screen** <sup>NEW!</sup>  
**Span adjustment is also done automatically**

Easy to open settings menu and span adjustment will be done automatically. The waveform is set to the most optimal scale to display.

Before span setting

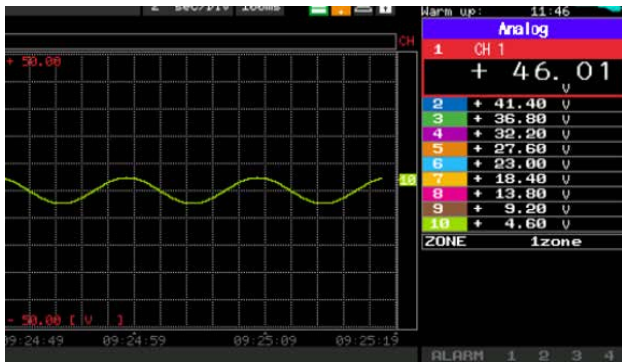

After span setting

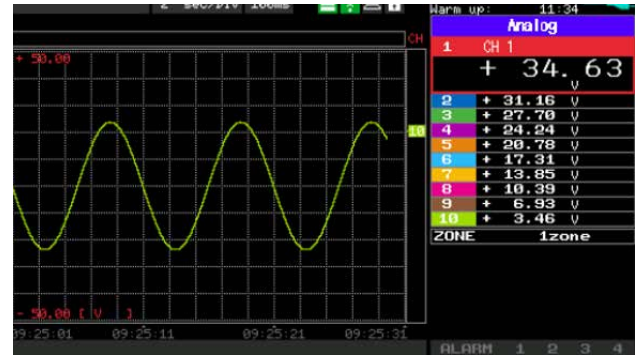

**Just click the botton to switch AMP settings** \*only when AMP settings is ON.

Push CH SELECT key to switch the CH category display Analog, Logic/Pulse, Calculation during Free Running.

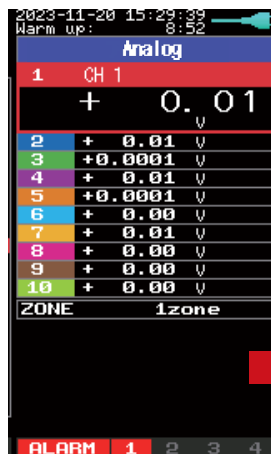

# Hide unnecessary menus

## Operability improvement

Unused functions can be hidden for even greater ease of use NEW!

The sophisticated menu group of the GL series has been improved more. Display/Hide can be selected from a list or wizard.

### Menu display setting window

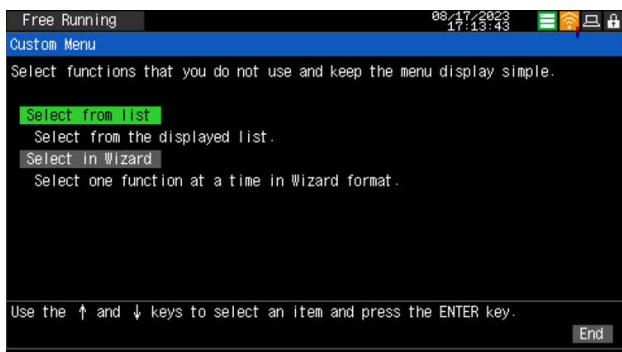

### Menu list screen



## <Menu display setting example>

### All menus ON



### All menus OFF

e.g. only operating measurement with START/STOP keys

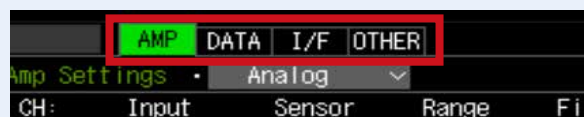

### All menus ON

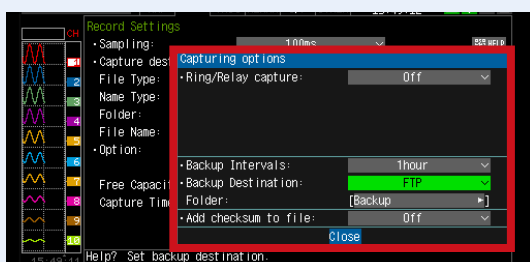

### Some menus OFF

e.g. do not use ring/relay capturing function

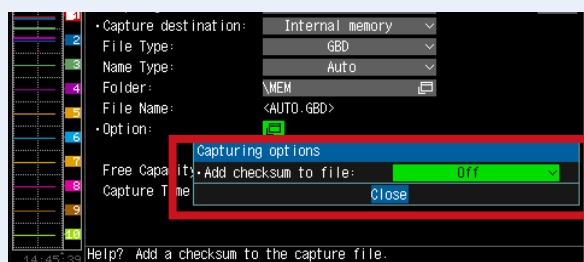

# HELP QR Code Display

## Operability improvement

### Access to FAQ of each functions

**NEW!**

HELP-QR codes of FAQ web page are installed in each setting window of GL260.



The screenshot shows the 'Amp Settings' window on the GL260 device. A 'HELP' button is visible in the top right corner. Below it, a QR code is displayed, which is highlighted with a red box. A red arrow points from this QR code to the website content on the right.

**Our website has been renewed!**

HOME > 計測Q&A > GL260 >

### What is the measured input impedance in ohms?

Mar 11, 2024

The input impedance will be 1MΩ.

\* Allowable signal source resistance is 300Ω or less.

## 3 Software

<b>GL28-APS</b>	<b>16</b>
<b>GL-Connection</b>	<b>17</b>

The software is included in the internal memory of GL260 when it is delivered.

Please copy it to PC with USB drive mode or download free of charge from the website.

Even while using the PC software, data can be transferred to the PC and saved to the internal memory at the same time. It can be used as backup data if PC failure or communication problem occurred.



Standard Included PC Software

# GL28-APS

## Check, record and save the waveform to your PC

Easy to use software with simple operation and sophisticated display design.

### Supported model

**Up to 10 units  
can be connected**

- GL260
- GL840 Series
- GL240 Series

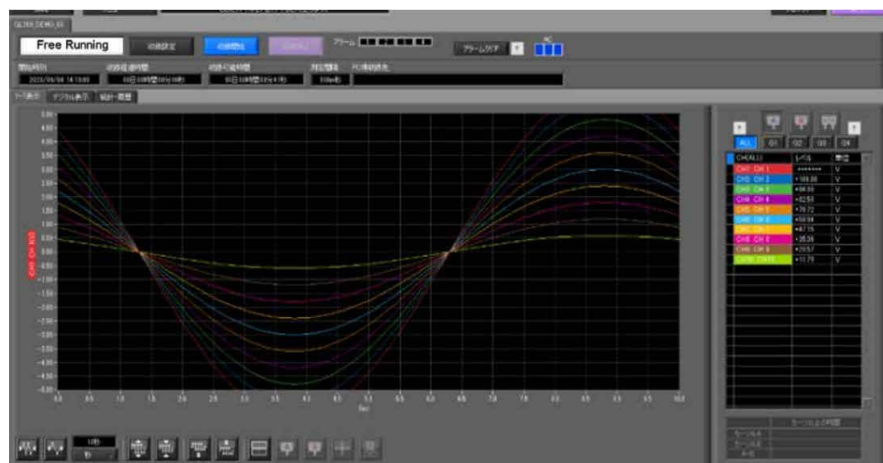

### Main Functions

- Various waveforms display
- Connected device search function
- Scheduling Function
- Search list display function
- Statistical display of any range (max, min, mean, P-P)
- Extract and save data
- The recording synchronization with multiple devices and automatic file synthesis function
- The direct-Excel function
- Save all playback data or convert between cursors

## GL Series Integrated Waveform Viewer

# GL-Connection

### Manage multiple GL series at once

By connecting various GL series devices via USB/LAN, GL series settings and real-time display of input signals, data recording, data playback, etc. can be performed from it.

#### Supported model (Current model)

- GL260
- GL7000
- GL2000
- GL980
- GL840 Series
- GL240 Series
- GLT400

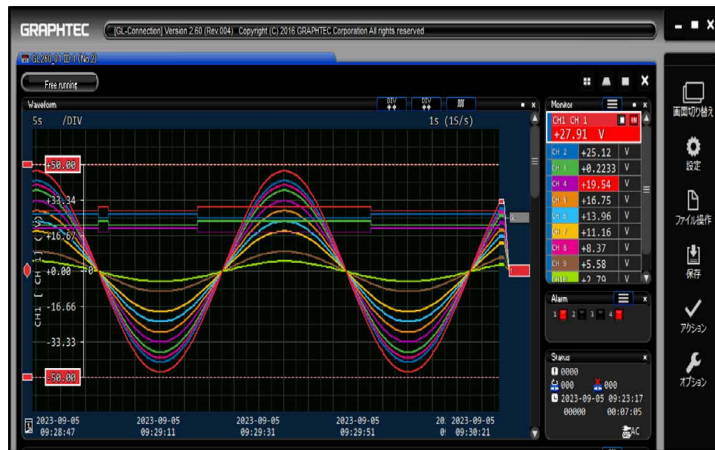

### Main Functions

#### Various waveforms display

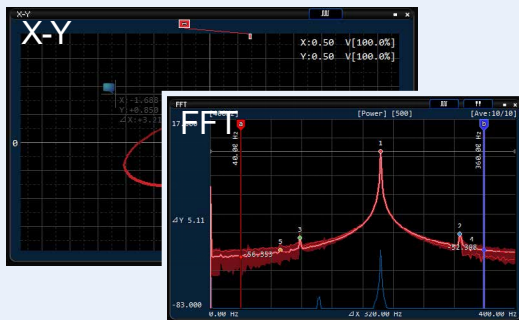

#### Multi-window function



#### Tab function

Ability to connect multiple units and merge recorded data

## 4. Other functions

<b>Screen</b>	<b>19</b>
Screen mode	19
Data confirmation screen during measurement	19
<hr/>	
<b>Operability</b>	<b>20</b>
Easy operation	20
<hr/>	
<b>AMP input</b>	<b>21</b>
Input type of analog input section, Filter	21
EU function (scaling function), Analog input terminal	22
<hr/>	
<b>Memory</b>	<b>23</b>
Recording destination, Sampling/recording time	23
Maximum recording time, Backup function	24
Ring/relay recording function, File save format	24
Replacing SD memory card during measurement	24
<hr/>	
<b>TRIGGER</b>	<b>25</b>
Trigger type/function	25
<hr/>	
<b>Alarm</b>	<b>26</b>
Alarm setting/output channel	26
External input/output cable	26
<hr/>	
<b>Interface</b>	<b>27</b>
Wireless LAN, USB cable	27
<hr/>	
<b>Statistics Calculations &amp; Searches</b>	<b>28</b>
Search function for playback data	28
Statistical calculation between cursors	28
<hr/>	
<b>Other functions</b>	<b>29</b>
Power supply form, Battery compatibility status	29
Compatible standards, Game function	29

# Screen

## Screen mode

A variety of screen modes are provided. The display is easy to see according to the customer's application.

### Wave + Digital screen

Ideal for viewing current values and changes (trends)

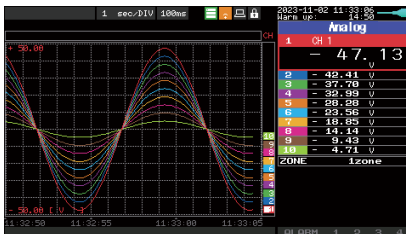

### Magnified waveform screen

The entire screen can be displayed as a waveform when you see changes (trends)

\*Waveform display can be switched between 1s/DIV and 24hour/DIV per DIV (in real time)

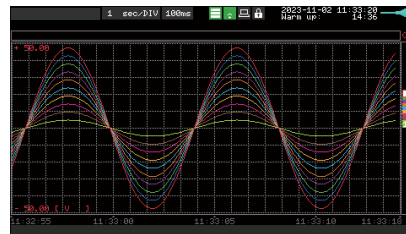

### Digital + Calculation

▼ If you want to see instantaneous data, you can view it by digital.

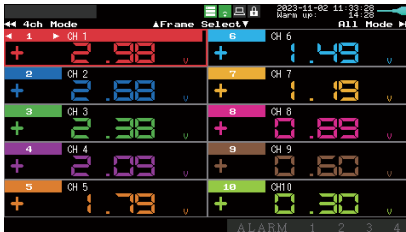

▼ Statistical calculation values can be displayed at the same time

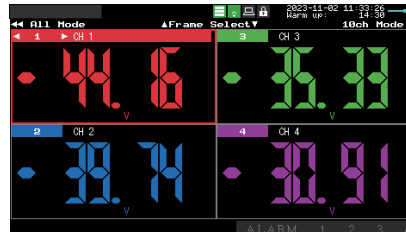

CH	VALUE	Rise	Max	Min	Peak
1	+ 40.11 v	+ 0.04	+ 47.50	- 47.50	+ 95.00
2	+ 36.09 v	+ 0.03	+ 42.75	- 42.75	+ 85.50
3	+ 32.08 v	+ 0.03	+ 38.00	- 38.00	+ 76.00
4	+ 28.07 v	+ 0.03	+ 33.25	- 33.25	+ 66.50
5	+ 24.06 v	+ 0.02	+ 28.50	- 28.50	+ 57.00
6	+ 20.05 v	+ 0.02	+ 23.75	- 23.75	+ 47.50
7	+ 16.04 v	+ 0.01	+ 19.00	- 19.00	+ 38.00
8	+ 12.03 v	+ 0.01	+ 14.25	- 14.25	+ 28.50
9	+ 8.02 v	+ 0.01	+ 9.50	- 9.50	+ 19.00
10	+ 4.01 v	+ 0.00	+ 4.75	- 4.75	+ 9.50

## Data confirmation screen during measurement

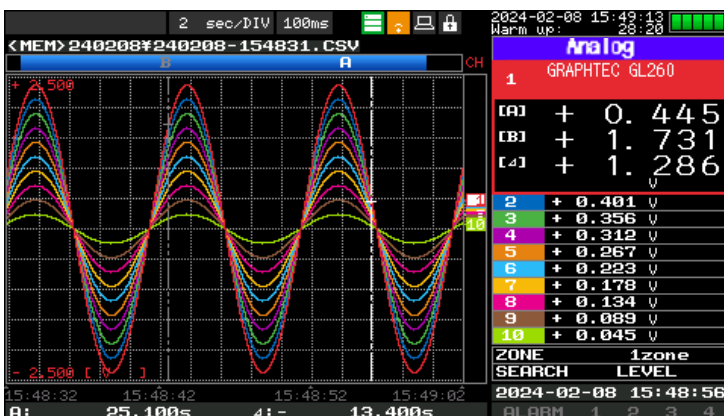

You can check the past data when you push the REVIE key while recording.

The past data can be scrolled with the cursor.

# Operability

## Easy operation <sup>NEW!</sup>

It is easier to see by changing the font and color saturation while simple operation that the cross key and ENTER key remains unchanged.

### Display color saturation

Easy to read display by changing the color saturation brighter

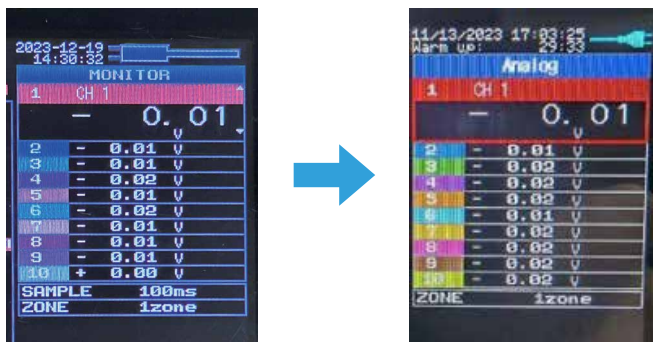

### MENU tree change

For a simple and intuitive tree

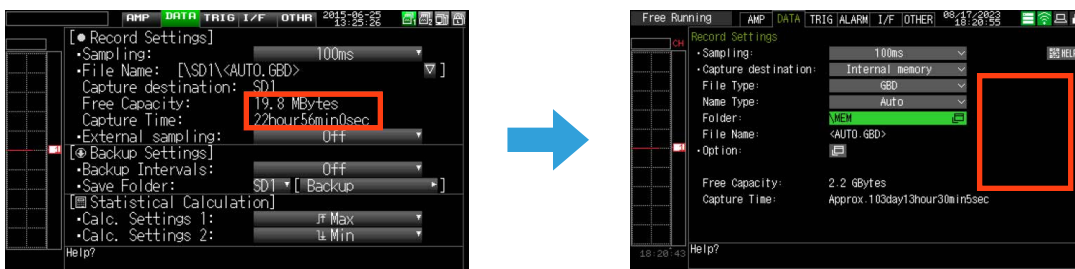

### New font

Visibility has been improved by changing margins



# AMP input

## Input type of analog input section \*Input type can be set for each channel

Analog channels are all isolated and multi-function inputs

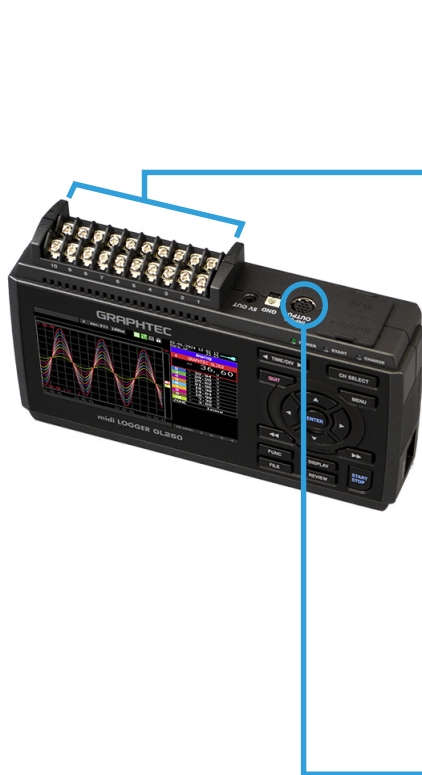

### Voltage

20mV - 100V

### Temperature

Thermocouple compatible (K,J,R,E,B,S,N,C (W))

### Humidity

0 - 100%  
(optional tool B-530 is required)



### Electric current

4 - 20%  
(optional tool B-551 is required)

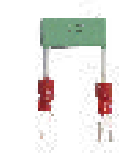

### Logic/Pulse

Selectable between 4 channels of logic input  
or 4 channels of pulse input  
(need to optional item, B-513)

- Logic: measure H/L
- Pulse: selectable RPM, instantaneous value, and integrated value for each channel



## Filter \*Analog channel only

Noise reduction, enable to set for each channel, moving average filter method  
Off, 2, 5, 10, 20, 40

# AMP input

## EU function (scaling function)

The sensor data can be output as voltage and converted to another unit for measurement.

(\*When inputting voltage on analog channel)

It can also be used for temperature measurement and pulse input.

### e.g. Humidity sensor

The sensor outputs humidity 0 - 100% with a voltage of 0 - 1 V

Measured value: Voltage 0 - 1 V

→ Converted value: Humidity 0 - 100%



## Analog input terminal

The analog channel terminal uses a highly versatile M3 screw terminal.

Easy wiring by just pinching to loosened screws.

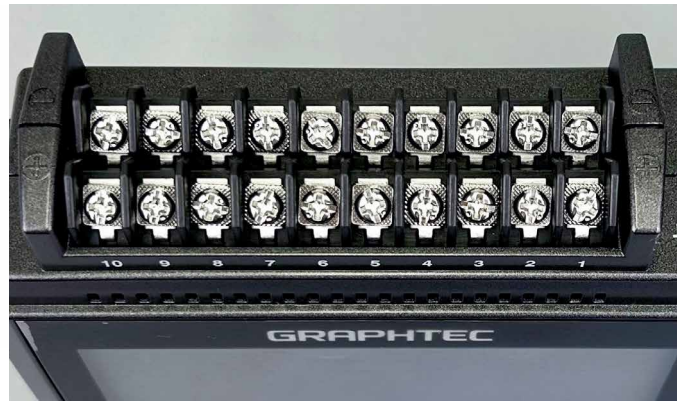
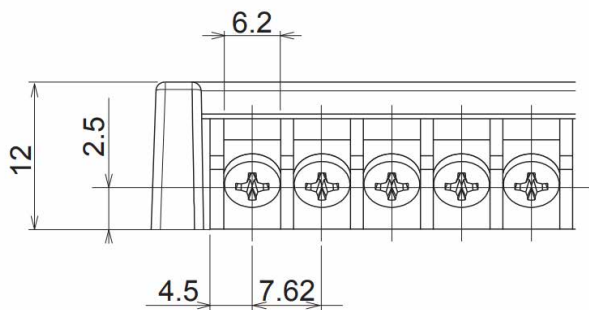



# Memory

## Recording destination

Large-capacity internal memory is installed to enable long-term recording. The recording destination can be selected from the internal memory or an SD memory card.

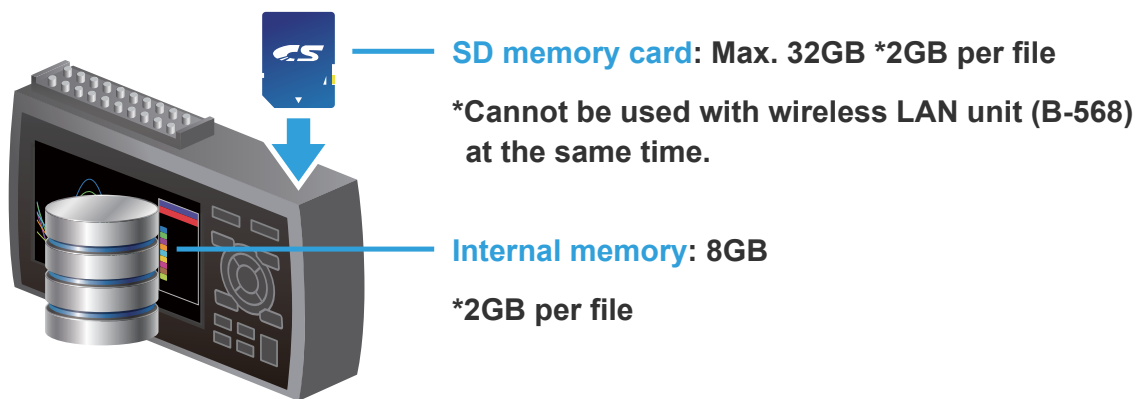

## Sampling/recording time

By narrowing down the number of channels, it is possible to record data at a maximum of 10ms.

Sampling interval		10ms	20ms	50ms	100ms
Number of usable channels		1	2	5	10
Measurement target	Voltage	●	●	●	●
	Temperature	-	-	-	●

## Maximum recording time

Large capacity 8GB memory for long recording times

Recording time example (analog 10ch, 2GB recording)

Sampling interval*	10ms	50ms	100ms	200ms	500ms	1s
GBD format	41 days	88 days	103 days	207 days	365 days or more	365 days or more
CSV format	3 days	12 days	18 days	36 days	91 days	182 days

\*The number of channels is limited depending on the sampling interval. 10ms: 1ch, 20ms: 2ch, 50ms: 5ch

# Memory

## Backup function (Backup destination: main unit memory, SD memory card, FTP)

Backups are performed at fixed intervals

(1 hour, 2 hours, 6 hours, 12 hours, 24 hours).

Autosave is available.

\*When saving in CSV format, please set sampling slower than 100ms.

## Ring/relay recording function

See page 9

Multiple recording functions for various applications

- Normal recording
- Ring recording function
- Relay recording function
- Relay recording function + memory loop function

## File save format

**GBD (Graphtec Binary Data) format**

→ Our proprietary binary format

**CSV format**

→ Data can be opened directly in Excel, making it convenient for creating reports.

## Replacing SD memory card during measurement

Memory can be replaced while recording without missing data.

Semi-permanent 24h recording is possible.

# TRIGGER

## Trigger type/function

Since the recording start/stops automatically according to the set conditions, only the needed data can be extracted.

Unattended measurements are possible under a variety of setting conditions. Enable to create files at any time.

Setting conditions (Can be set for both start and stop sides)

Off / Level / Alarm / External / Time / Day of the week / Fixed time



External trigger (requires optional B-513)

Recording can be started or stopped using a signal from an external device as a trigger.



Input signal No-voltage contact (A contact, B contact, NO, NC), open collector, voltage input Conditions at input voltage  
Voltage: 0 to +24V, Threshold voltage: approx. +2.5V Hysteresis: 0.5V (+2.5V to 3V)

# Alarm

## Alarm setting/output channel <sup>NEW!</sup>

Alarm conditions can be set for each channel: analog input channel, logic/pulse channel, and calculation channel.

### <Screen image>

Analog



Calculation

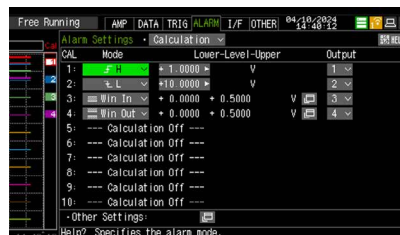

Logic/pulse

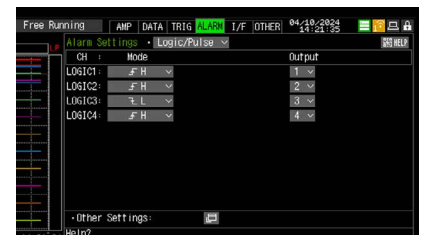

### Alarm output

There are 4 ports, and the output port can be selected for each channel.

Signal output is possible from the output port

(\*optional tool B-513 is required)

### Alarm output signal

Open collector output (5V pull-up resistor 10KΩ)

## External input/output cable

When using the external output function, the optional GL input/output cable (B-513) is required.



When an alarm occurs, you can be notified by email.

(\*Optional B-568 is required)

Errors are detected automatically and a screen copy of the occurrence will be attached to the notification email.

# Interface

Connection to a PC can be made via USB or wireless LAN.

\*Optional B-568 is required for wireless LAN connection. The USB connection is a common A-B type cable.

## Wireless LAN (access point (base unit)/station (child unit))



Wireless LAN unit (option B-568)

\*It is impossible to use with SD memory card

Connection between GL main unit (access point) and device (PC/smartphone)

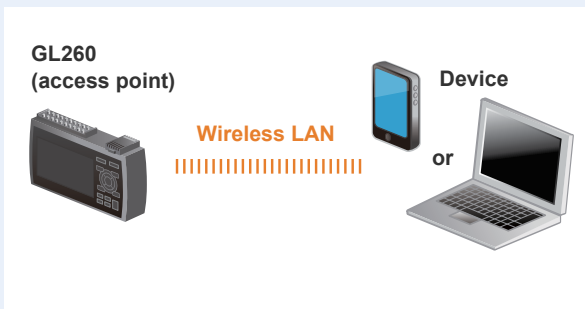

Connection between GL main unit (station) and remote device (PC/smartphone)

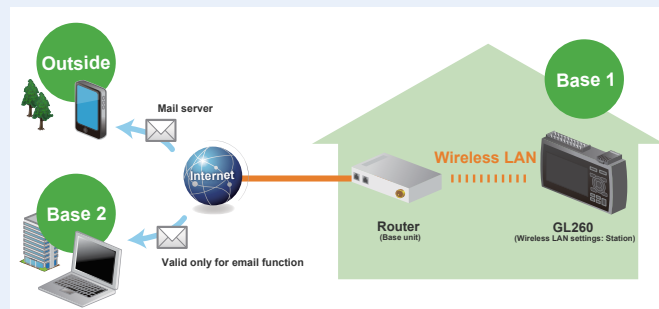

## USB cable

Connect GL260 and PC with USB cable and data can be easily transferred to a PC by turning on the power while pressing GL260 [START/STOP] key. (USB drive mode function)

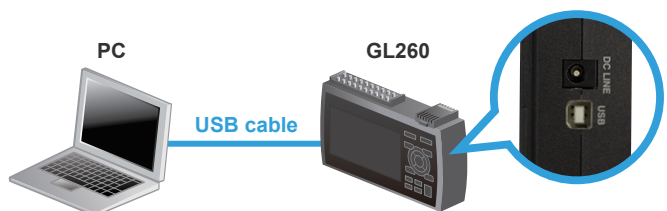

\*USB cable is not included. Please use a commercially available A-B type.

# Statistics Calculations & Searches

## Search function for playback data NEW!

The relevant point can be searched from a huge amount of data by using set conditions.

Move the cursor to the set condition value.

Also, recorded data can be played back and searched while recording.



## Statistical calculation between cursors

- Statistical calculation results of playback data are displayed instantly.
- No need to check the entire data  
(Instantly access the points you want to look by the search function)

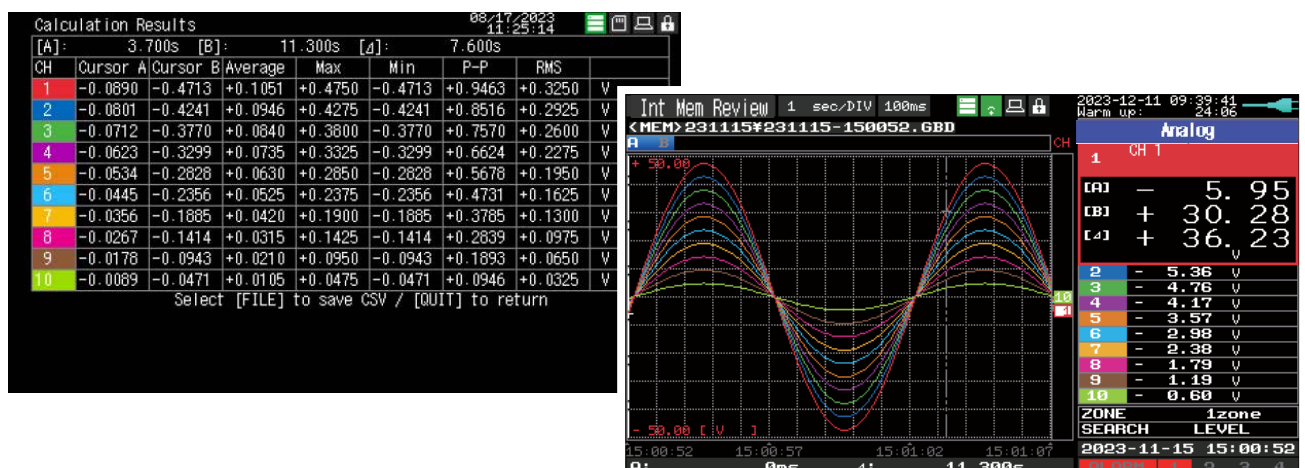

# Other functions

## Power supply form

Power supply formats can be selected according to the application.

AC100V power supply: enable to use with the included AC adapter.

DC power supply: requires optional DC drive cable B-514.

DC8.5V to 24V

Battery powered: requires optional dedicated battery B-573.

## Battery compatibility status

Model/Battery	B-569	B-573
GL260	*	Y
GL2000/GL980	Y	-
GL840	Y	-
GL240	Y	-

\* Battery performance reduce by 20%

## Compatible standards

Compatible with Radio Law, RoHS, and CE mark

## Game function

Game function has come back to help you get used to the controls.





## 5. Options/Specifications

<b>Options</b>	<b>31</b>
<b>Specifications</b>	<b>32</b>
Body specifications	32
Analog input section specifications	33
PC software (GL28-APS) specifications	34
PC software (GL-Connection) specifications	34
Standard included accesary	35

# Options

Item	Model number	Description
Input/output cable for GL series	B-513	2 m long (no clip on end of cable)
DC drive cable	B-514	2 m long (no clip on end of cable)
Humidity sensor	B-530	3 m long (with power plug) Allowable temperature range (-25 to 80°C)
Wireless unit	B-568	Wireless LAN
Battery pack	B-573	7.2V / 2875mAh
Shunt resistance 250Ω	B-551	±250 Ω (0.1%), Rated power of 1 W
Type T ultrafine thermocouple (TC200×TD1000)	ST-55K-TC-1.2M	Tip wire φ0.127, 0.5X0.7X200mm, relaying 1m, -40 - 260°C, class 2, 5 units
Rod-shaped thermocouple K type	RIC-410	-100 - 300°C, class1, length 1.1m
Type K ultrafine thermocouple	RIC-440	5-piece set , Connectable thermocouple: Bare wire diameter 0.65mm, M3 Y terminal
Mini-connector for T type thermocouple	RIC-450	5-piece set , Connectable thermocouple: Bare Wire diameter 0.65mm, M3 Y terminal

# Specifications

## Body specifications

Item	Description	
Number of analog input channels	10 channels	
External input/output (*1)	Input	Input: Trigger or Sampling (1 channel), Logic/Pulse (4 channels) Input voltage range: 0 - +24V (single-ended input) Input signal: No-voltage contact (a contact, b contact, NO,NC), Open collector, Voltage input
	Output	Alarm output (4 channels) Output format: Open collector output (+5 V, 10 KΩ pull-up resistance)
Sampling interval	10 ms to 1 hour (10ms to 50ms: voltage only, number of channels is limited), External signal (*1)	
TIME / DIV	1sec. to 24 hour /division	
Trigger function	Repeat action	Off · On
	Trigger action	Start or stop capturing data by the trigger
	Trigger source	Start: Off, Level, Alarm, External, Date, Weekly or Time Stop: Off, Level, Alarm, External, Date, Weekly or Time
Alarm function	Condition Setting	Combination: OR or AND Analog signal: Rising (High), Falling (Low), Window-in, Window-out Logic signal: Pattern (combination of each input signal in high or low) Pulse (number of count): Rising (High), Falling (Low), Window-in, Window-out
Pulse input function	Measurement mode	Rotation count (RPM) mode Accumulating count mode Instant count mode
	Maximum number of pulse inputs	Maximum input frequency: 50kHz Maximum number of count: 50kC/sampling (16-bit counter)
PC I/F	USB (Hi-speed), WLAN (using B-568 option)	
Storage Device	Internal memory	Approx. 8GB
	SD card slot	1 (Supports SDHC, Up to approx. 32GB memory available) *Up to 2GB per file *Unable to use the SD card slot when using the optional wireless LAN unit
	Contents	Setting conditions of the main unit, Recorded data, Screen capture
Operating environment	0 to 45 °C, 5 to 85% RH (When operating with battery pack 0 to 40 °C, charging battery 15 to 35 °C)	
Power source	AC adapter	100 to 240 V AC, 50/60 Hz
	DC power	8.5 to 24 V DC (Max. 26.4V)
	Battery pack	7.2V DC, 2875mAh (Battery pack option)
Power consumption	Max. 36 VA (Rating under maximum power consumption using the AC adapter, with LCD display on, and battery pack being charged, 100 V AC)	
External dimensions (W x D x H)	Approx. 188 x 117 x 42mm (Excluding protrusions)	
Weight	Approx. 500g(Excluding AC adapter and battery pack)	
Earthquake resistant	Automotive parts Class 1A equivalent	

\*1 Input/Output cable for GL (option B-513) is required to connect the signal.

# Specifications

## Analog input section specifications

Item	Description			
Type of analog input terminal	Screw terminal (M3 screw)			
Input method	Photo MOS relay scanning system All channels isolated, Balanced input			
Measurement range	Voltage	20, 50, 100, 200, 500 mV, 1, 2, 5, 10, 20, 50, 100 V, and 1-5V F.S. (Full Scale)		
	Thermocouple	Type: K, J, E, T, R, S, B, N, and W (WRe5-26)		
	Humidity	0 to 100% (voltage 0 to 1 V scaling conversion)(using option B-530)		
Filter	Off, 2, 5, 10, 20, 40 (moving average in selected number)			
Measurement accuracy(*2) (23°C±5°C) -At least 30 minutes after turning the power on - Sampling speed 1s/ 10ch - Filter ON (10) - GND ground	Temperature	Voltage	Voltage: ±0.1% of F.S.	
		Thermocouple	Measuring temperature range (°C)	Measurement accuracy
			R/S	$0 \leq TS \leq 100^{\circ}\text{C}$ ±5.2°C $100 < TS \leq 300^{\circ}\text{C}$ ±3.0°C R : $300 < TS \leq 1600^{\circ}\text{C}$ ± (0.05% of rdg + 2.0°C) S : $300 < TS \leq 1760^{\circ}\text{C}$ ± (0.05% of rdg + 2.0°C)
		B	$400 \leq TS \leq 600^{\circ}\text{C}$ ±3.5°C $600 < TS \leq 1820^{\circ}\text{C}$ ± (0.05% of rdg + 2.0°C)	
			K	$-200 \leq TS \leq -100^{\circ}\text{C}$ ± (0.05% of rdg + 2.0°C) $-100 < TS \leq 1370^{\circ}\text{C}$ ± (0.05% of rdg + 1.0°C)
		E	$-200 \leq TS \leq -100^{\circ}\text{C}$ ± (0.05% of rdg + 2.0°C) $-100 < TS \leq 800^{\circ}\text{C}$ ± (0.05% of rdg + 1.0°C)	
			T	$-200 \leq TS \leq -100^{\circ}\text{C}$ ± (0.1% of rdg + 1.5°C) $-100 < TS \leq 400^{\circ}\text{C}$ ± (0.1% of rdg + 0.5°C)
		J	$-200 \leq TS \leq -100^{\circ}\text{C}$ ±2.7°C $-100 < TS \leq 100^{\circ}\text{C}$ ±1.7°C $100 < TS \leq 1100^{\circ}\text{C}$ ± (0.05% of rdg + 1.0°C)	
			N	$-200 \leq TS < 0^{\circ}\text{C}$ ± (0.1% of rdg + 2.0°C) $0 \leq TS \leq 1300^{\circ}\text{C}$ ± (0.1% of rdg + 1.0°C)
		C	$0 \leq TS \leq 2000^{\circ}\text{C}$ ± (0.1% of rdg + 1.5°C)	
		Reference contact compensation accuracy		±0.5°C
		A/D converter	Resolution	16Bit (Effective resolution: Approx. ±1/ 40000 of the measuring full range)
		Input resistance	1MΩ±5%	
Maximum input voltage	Between(+) / (-) terminal	- 20mV - 1V range (60Vp-p) - 2V - 100V range (110Vp-p)		
	Between input terminal and input terminal	60Vp-p		
	Between input terminal and GND	60Vp-p		
Withstand voltage	Between input terminal and input terminal	350Vp-p 1minute		
	Channel / GND	350Vp-p 1minute		

(\*2) Thermocouples used are T/K: 0.32φ, others: 0.65φ.

# Specifications

## PC software (GL28-APS) specifications

Item	Description
Supported OS	Windows 11 (64bit)/Windows 10 (32bit/64bit) *Operating system that is no longer supported by the OS manufacturer will no longer be supported by us.
Function	Main unit control, realtime data recording, data conversion
Number of groups	4 groups MAX
Number of CHs per 1 group	Up to number of connected module
Maximum number of channels	1000ch
Settings	AMP settings, recording settings, trigger/alarm settings, report settings, others
Recorded data	Realtime data (CSV, GBD Binary) Data in Internal memory or SD memory card (CSV, GBD binary)
Display	Analog waveforms, logic waveforms, pulse waveforms, digital values
Display modes	Y-T View, Digital View, X-Y View between Cursors (only during replay)
File conversion	Between cursors, All data
Monitor functions	Alarm monitor enables sending of email to the specified address
Statistic/ History	Displays maximum, minimum and average values during measurement
Report function	Enables creation of daily or monthly files

## PC software (GL-Connection) specifications

Item	Description
Supported OS	Windows 11 (64bit)/Windows 10(32bit / 64bit) *Operating system that is no longer supported by the OS manufacturer will no longer be supported by us.
Function	Main unit control, Real time data recording, Conversion, data playback
Number of units connected	Up to 20 units can be mixed and matched via USB and LAN
Display	Analog waveform, Logic waveform, Pulse waveform, Digital waveform
Display mode	Y-T view (Digital view), X-Y View between cursors (data reply only) FFT display, cursor information, recording information display, alarm information display, etc.
Multi-screen function	Up to 4 separate screens to display different waveforms at the same time
Recorded data	Real time data (CSV,GBD binary) Internal memory or SD memory card data (CSV,GBD binary) *Sampling is limited by conditions.
Statistic/ History	During recording: Maximum, Minimum, Average, Peak During playback cursor: Maximum, Minimum, Average, Peak, RMS
Direct-Excel Function	Transfer recorded data directly to Excel
E-mail send function	The e-mail is sent to the specified address when the alarm monitor is performed

# Specifications

## Standard included accessory

Item	Description
Quick Start Guide	1
AC adapter	100 to 240 VAC, 50/60 Hz, Power supply cord for each area: 1
Ferrite core	This is used to attach to the USB cable: 1

- Due to the possibility of equipment or PC failure, the data files on the instrument will not be guaranteed to be held on the memory.
- Please make a backup of data whenever possible to avoid data loss.
- Brand names and product names listed in this brochure are the trademarks or registered trademarks of their respective owners.
- Items mentioned are subject to change without notice. For more information about product, please check the web site or contact your local representative.



For using equipment in correctly and safely

- Before using it, please read the user manual and then please use it properly in accordance with the description.
- To avoid malfunction or an electric shock by current leakage or voltage, please ensure a ground connection and use according to the specification.

 **Ai Holdings Group**  
**GRAPHTEC**  
Graphtec Corporation

503-10 Shinano-cho, Totsuka-ku, Yokohama 244-8503, Japan  
Tel : +81-45-825-6250 Fax : +81-45-825-6396



GL260\_d\_KE10993\_1D