



M550 Impedance Calibrator

user manual



Content

1. Introduction	5
1.1. Front panel overview	6
1.2. Rear panel overview	8
1.3. Accessories	8
1.4. Remote control	9
2. Getting started	10
2.1. Safety precautions	10
2.2. Power on and warm-up	11
2.3. Function setup	11
2.4. Connection / disconnection of output terminals	12
2.5. What to do in case of failure	12
3. Menu reference	13
3.1. General Menu	13
3.2. Interface Menu	13
3.3. Meter	13
3.4. Calibration	13
4. Basics of LCR calibration	14
4.1. Terminology	14
4.2. 4TP Four terminal pair standards	14
4.3. Partial standard selection	15
4.4. Change of the bank mode 4TP to 4W/2W	16
4.5. Correction ON/OFF	16
4.6. SHORT/ OPEN	17
4.7. External input	17
4.8. Z/Y switch	17
4.9. Meter operation	18
4.10. Local/Remote operation	18
5. Calibration example	19
5.1. LCR meter calibration with four terminal pair connection (4TP)	19
5.2. LCR meter calibration with four terminal connection (4W)	21
5.3. LCR meter calibration with two terminal connection (2W)	22
5.4. Application of signal level meter	23
6. Performance verification	24
6.1. Required equipment	24
6.2. Verification procedure	24
7. Adjustment	30
7.1. Access to recalibration	30
7.2. Recalibration structure	30
7.3. Recalibration procedure	33
8. Maintenance	36
8.1. Fuse replacement	36
8.2. Exterior cleaning	36
8.3. Air filter cleaning	36

8.4.	Error messages	36
9.	Specifications	37
9.1.	Resistance	38
9.2.	Capacitance	38
9.3.	Inductance (simulated in 4TP mode only)	38
9.4.	Test level meter	38
9.5.	4TP Resistance standards (coaxial output)	39
9.6.	4TP Capacitance standards (coaxial output)	41
9.7.	4TP Inductance standards (coaxial output)	44
9.8.	Resistance standards 4W and 2W (banana output)	46
9.9.	Capacitance standards 4W and 2W (banana output)	47
9.10.	OPEN/SHORT parameters	48
	Certificate of conformity	50

List of tables

Table 1	4TP Resistance verification test	24
Table 2	4TP Capacitance verification test	25
Table 3	4TP Inductance verification test	25
Table 4	4W Resistance verification test	26
Table 5	4W Capacitance verification test	27
Table 6	2W Resistance verification test	28
Table 7	2W Capacitance verification test	29
Table 8	Error message description	36
Table 9	4TP Capacitance	44

List of figures

Figure 1	Front panel	6
Figure 2	Display	7
Figure 3	Rear panel	8
Figure 4	T resistance network	14
Figure 5	T inductance network	15
Figure 6	Principle of 4TP test lead connection	19
Figure 7	DUT connection in 4TP mode	20
Figure 8	Four wire connection	21
Figure 9	Two wire connection	22
Figure 10	Standard LCR meter connection for 4W capacitance standard verification	27
Figure 11	Standard LCR meter connection for 2W capacitance standard verification	29
Figure 12	Calibration values history	32
Figure 13	Offset calibration	33
Figure 14	Full calibration	34

1. Introduction

M550 Impedance calibrator is designed for LCR meter verification and calibration. The calibrator integrates partial resistance standards in decade series with range of values from 100 m Ω up to 100 M Ω , capacitance standards with range from 10 pF up to 100 μ F and inductive standards with the range from 10 μ H up to 10 H. For test leads and unit under test electrical zero compensation the calibrator is equipped with reference positions of short-circuit terminals SHORT and open-circuit terminals OPEN. Summary frequency range covers band from 20 Hz up to 1 MHz, however some partial standards have lower applicable frequencies. Partial standards feature low temperature coefficient, excellent long term stability and low frequency dependency.

The calibrator offers two banks of standards. The more accurate bank is equipped with four output BNC connectors. It is aimed for calibration of LCR meters based on auto-balancing bridge principle using four-pair-terminal technique (4TP) of test terminal connection. The second bank (4W/2W) is equipped with 4mm output banana terminals and it's aimed for calibration of LCR meters based on I-V method with non-coaxial test terminals. Practically this bank can be used in four-wire (4W) or two-wire (2W) measurements.

M550 has a built-in test signal level meter which can be easily used for verification of test signal voltage, current and frequency. Color LCD display shows parameters of a selected standard, set-up configuration, calibration data accuracy and other useful information.

Impedance calibrator should be periodically recalibrated. Recommended recalibration interval is 1 year. Internal calibration data are accessible via front panel keyboard. Calibration memory is protected with a calibration password.

All functions of the calibrator can be controlled by IEEE-488 interface or via RS-232 serial line.

1.1. Front panel overview

Main control segments of the calibrator are:

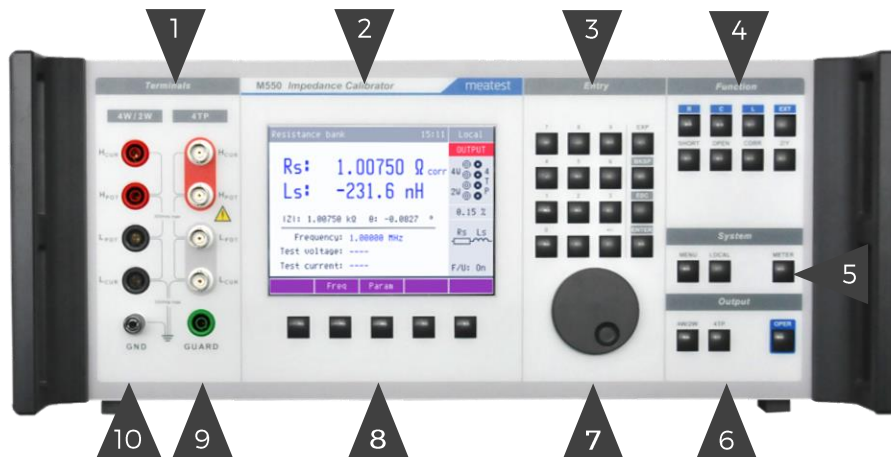

Figure 1 Front panel

1. Output terminals – Calibrator contains two sets of output terminals. Both sets are electrically isolated from each other.

4TP – coaxial BNC output for calibration of BNC terminal LCR meters. Shielding of the BNC connectors is isolated and connected together inside the bank of standards in one point to obtain the lowest frequency dependency. 4TP output is suitable for calibration of LCR meters with coaxial input connectors.

4W/2W – 4mm banana non-coaxial output for calibration of four and two wire LCR meters. While in 4W mode all four terminals are applied for DUT connection, in 2W mode only HCUR and LCUR terminals have defined impedance parameter.

Note: In 2W mode both HCUR – LCUR and HPOT – LPOT terminals are connected to internal partial standard however calibration values are defined between HCUR – LCUR terminals.

Meaning of individual terminals is as follows:

H _{CUR}	high source current terminal
H _{POT}	high sense voltage terminal
L _{POT}	low sense voltage terminal
L _{CUR}	low sense current terminal

2. Display – More in chapter 1.1.1.
3. Numeric keys – Numerical values can be entered from the keyboard. ENTER button is used to confirm the selection. CANCEL button is used to cancel the entry.
4. Function keys – Function buttons can be used to call up the functions of the calibrator directly.
5. System keys – Group of buttons enable access to system parameters
6. Selection of output mode – The buttons enable selection one of two outputs either 4TP or 4W/2W and switching output terminals ON/OFF.
7. Rotary knob – The rotary knob integrates several functions. By turning the knob to the left or right, the user can:
 - Step through the options in menus
 - Select L-C-R partial standard according to its nominal value
 - Enter numerical values

When making a menu selection, pushing in on the knob is equivalent to pressing the SELECT soft key. When editing a number, pressing in on the knob will switch between moving the cursor between

characters and changing the selected character's value. Arrow icons above and below the selected digit indicate which of the two modes are active.

8. Soft keys - There are five buttons below the display, which meaning changes depending on the content of the display. These buttons usually call up local menu with parameters setting, modes, etc. or enable to close currently opened function or menu.
9. Guarding terminal – Guarding terminal. It is connected to shielding of the 4TP coaxial output connectors. It has no function in 4W or 2W mode.
10. Grounding terminal – Grounding post is joined to metal parts of housing and to protective earth in power line socket.

1.1.1. Display in detail

Display is divided into several sections with following meaning:

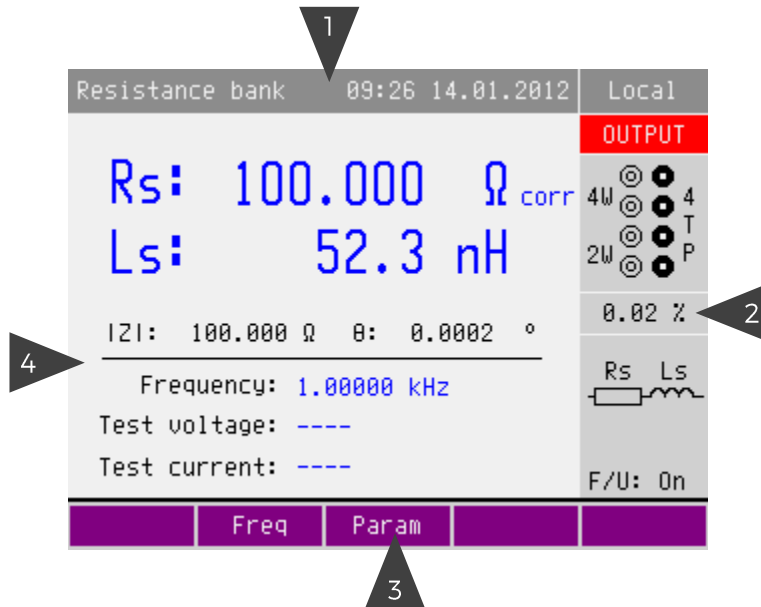

Figure 2 Display

1. Information line from left to right:
 - Type of selected bank Resistance, Capacitance, Inductance
 - Current date/time. Displaying of the date and time can set to be hidden in setup menu.
 - Local/remote mode status indication tooltip. Shows additional information about selected parameter or main value. Information may include uncertainty, range, description, limits (burden current, compliance voltage), etc. Tooltip is hidden when no parameter is selected.
2. Auxiliary parameter field from top to bottom:
 - Status of output terminals ON or OFF
 - Selected output terminals and basic mode 4TP or 4W/2W indication
 - Calibration uncertainty of the selected standard at selected frequency
 - Parallel or serial equivalent circuit of the displayed calibration values
 - Working mode of built-in test signal level meter ON/OFF
3. Soft button line:
 - Soft buttons description. If there is no description above soft button, the button is not active in selected function.
4. Meter reading. Main parameter field from top to bottom:
 - Both main complex parameters of selected standard in selected frequency point including type of displayed values. In the upper line primary parameter, in the bottom line secondary parameter is always displayed.
 - Indication of function CORRECTION ON or OFF. Symbol “corr” is displayed beside the main parameter if Correction is ON.
 - Z/θ normalized polar format calibration values of the selected standard

- Selected (or measured) test frequency
- Measured test voltage and frequency sourced by DUT
- Calculated test current

Colors on display

Common rules are used for an applied color of labels and values.

- Red color is applied, when displayed value is measured by M550 calibrator.
- Blue color is applied for parameters or values, which can be set up or modified
- Black color is used for fixed values, labels, notes, parameters which cannot be modified and for other fixed text with a general information purpose.

1.2. Rear panel overview

There is located power line socket, power line fuse and power line voltage selector 115/230V integrated in power entry module, interface connectors GPIB, RS232, metal central grounding post and four coaxial connectors for external standard (function EXT).

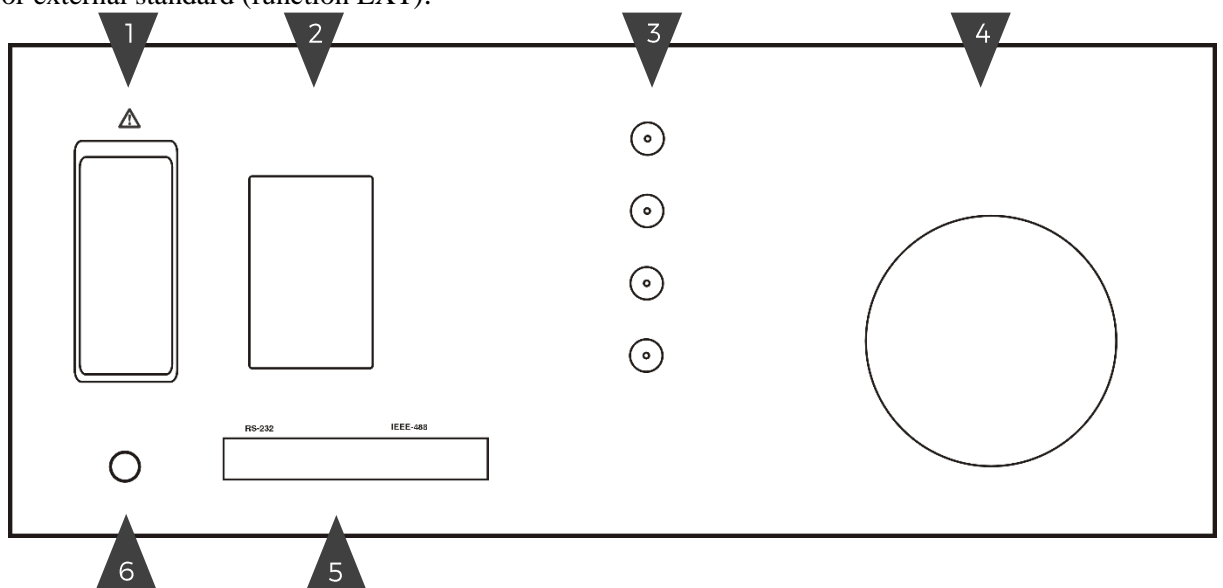

Figure 3 Rear panel

1. Power entry module with power line switch, power line with fuse and voltage selector
2. Model plate
3. EXT input with BNC connectors
4. Ventilation hole
5. RS-232, GPIB connectors
6. Central grounding post

1.3. Accessories

Every M550 Impedance calibrator delivery includes following items:

- | | |
|------------------------------|-------|
| - USB stick with user manual | 1 pc |
| - Mains supply cord | 1 pc |
| - Coaxial cables BNC-BNC | 4 pcs |
| - Test lead banana-banana | 4 pcs |
| - Adaptor BNC/banana | 4 pcs |
| - Spare fuse | 1 pc |
| - RS232 cable | 1 pc |
| - Test report | 1 pc |

1.4. Remote control

The calibrator can be integrated into automated calibration systems (ATS) and generally controlled from remote computer via following remote control interfaces:

- RS232
- GPIB (IEEE488)

When controlled remotely, maximum ratings of calibrator's output signals as well as all other specifications are the same as in manual mode.

Meatest software package WinQbase + Caliber is recommended for best automation results. This system is designed for automated and semi automated calibrations of digital and analogue meters including uncertainty calculation, result evaluation and certificate printing according to ISO 17025 standard.

1.4.1. Connection setup

Only one interface can be used for communication at any given time. Default active interface is RS232, other interfaces can be selected in MENU->Interface->Active interface. To establish connection between the calibrator and computer, set interface settings in your computer accordingly:

RS232

- COM port see available COM ports in Windows Device Manager
- Baudrate RS232 according to MENU->Interface->RS232 Baudrate (9600 by default)
- Data bits 8
- Stop bits 1
- Parity None
- Handshake (XON/XOFF) Off

GPIB connection settings

- GPIB Address according to MENU->Interface->GPIB Address (2 by default)

1.4.2. SCPI commands and protocol

See M550 SCPI manual for complete SCPI reference, more details on communication setup and troubleshooting.

2. Getting started

Inspect package contents when unboxing the calibrator for the first time. See chapter 1.3 for complete list of accessories.

Place the instrument on a level surface before powering on and let it stabilize for at least one hour if the instrument has been stored outside of reference temperatures beforehand.

2.1. Safety precautions

The instrument has been designed in Safety Class I according to EN 61010-1. The design reflects the requirements of A2 amendment of the standard. Safety is ensured by the design and by the use of specific component types. The manufacturer is not liable for the damage caused by modification of the construction or replacement of parts with non-original ones.

Safety symbols used on the equipment:



Warning, risk of danger.



Warning - risk of electric shock. Hazardous voltage above 50 V DC or AC might be present.



See User Manual.



Protective earth.



Fuse.

To prevent possible electrical shock or personal injury:

- Read carefully safety information before you use the Product.
- Do not alter the Product and use only as specified, or the protection supplied by the Product can be compromised.
- Do not use the Product if it is altered or damaged.
- Use this Product indoors only.
- Use power cord approved for local mains voltage and plug configuration and rated for the Product.
- Keep hands away from all Product terminals and exposed metal cable parts during operation. High voltage on those may be cause death or serious injury.

2.2. Power on and warm-up

The calibrator must be powered by 230/115 V – 50/60 Hz mains. Before connecting the instrument to the mains, check the position of the mains voltage selector located on the rear panel. Set appropriate voltage selector position either 115 V or 230 V.

Plug one end of the power cord into connector on the rear panel and connect the other end of the power cord into a wall outlet. Turn the calibrator on with mains switch right next to it.

The calibrator performs internal hardware checks for 5 seconds. During initialization label M550 Impedance calibrator is displayed.

Warm-up

The calibrator works after it is switched on and the initial checks complete. Specified parameters are guaranteed after switching the calibrator on and stabilizing it in reference conditions.

2.3. Function setup

Function buttons can be used to call up the functions of the calibrator directly. The following buttons are provided:

Function	Key
Resistance bank selection	R
Capacitance bank selection	C
Inductance bank selection	L
External standard	EXT
Reference SHORT	SHORT
Reference OPEN	OPEN
Correction ON/OFF	CORR
Z or Y parameters displaying	Z/Y

2.4. Connection / disconnection of output terminals

Push the OPER button to switch output terminals on. The selected partial standard is available at the output terminals either coaxial or banana terminal depending on the selected mode 4TP or 4W/2W. Status of the output terminals is shown on the display with following meaning:

OUTPUT

output terminals OFF

OUTPUT

output terminals ON

2.5. What to do in case of failure

If an obvious failure occurs during the operation (e.g. the display is not lit, the fan is not turning), the calibrator must be switched off immediately. First, check the fuse located in the power cord receptacle. Procedure is following:

- Remove the end of power cord from the mains connector at the rear panel.
- Insert the blade of a flat screwdriver into the opening cut in the mains voltage selector and pry out the fuse holder.
- Remove the fuse. Replace it with new fuse of the same rating if the fuse was broken.
- Replace the fuse holder, reconnect the power cord and switch on the calibrator. If the problem persists, contact the manufacturer.

If an obvious fault is evidenced, e.g. a measurement range or an operating mode is not functional, the user cannot correct the fault. Contact the manufacturer.

Hidden faults can cause different symptoms and be caused by different causes. Usually, they cause instability of some parameter. Hidden defects can be caused by unacceptable distortion, degraded insulation etc. In this case contact the manufacturer.

Sometimes it seems that the calibrator has hidden defect, when the rules for correct operation are not adhered to. In this case, the fault is caused by the operator. Most frequent cases of false “hidden defects”:

- mains voltage out of tolerance limits or unstable
- wrong grounding of the measurement circuit (bad connection of the ground terminal of the mains outlet, or several ground connections when grounding loops are formed)
- proximity to sources of intensive influence, whose products are spread through the mains or propagated by the electromagnetic field
- strong electrostatic or electromagnetic field which can cause major instability during calibration using higher impedance.

3. Menu reference

Press the MENU button to enter to main system MENU.

3.1. General Menu

Submenu contains basic parameters of display and keyboard.

- Language Language version of user interface
- Volume [0 – 15]
- Brightness [0 – 7]
- Beeper [On/Off]
- Phase unit [deg/rad]
- Password setting Sets new calibration password
- Time System time in HH:MM:SS format
- Date System date in selected format [DD.MM.YYYY]
- Date/Time [On/Off]
- Device Information Shows serial number, HW & SW versions, etc.

3.2. Interface Menu

Submenu contains remote control parameters.

Menu item	Range / format	Default value
Active interface	RS232 (Baudrate)/IEEE488	RS232
Baud rate	1200 – 115200	9600
IEEE488Address	0 – 31	2

3.3. Meter

Submenu contains setting of built-in volt meter / counter to position:

- Off meter is disabled
- On reading of meter is enabled

3.4. Calibration

Access to calibration memory is enabled through this item. See chapter 7. for detailed information.

4. Basics of LCR calibration

M550 Impedance calibrator is designed for calibration of LCR meters. It contains partial standards of resistance, capacitance and inductance of fixed decimal values. The calibrator offers two outputs:

- 4TP coaxial output for calibration of LCR meters which are equipped with BNC coaxial terminals.
- 4W/2W 4 mm terminal output for calibration of non-coaxial LCR meters with 2 or 4 banana input terminals. 4W/2W output offers two-wire or four-wire connection.

4.1. Terminology

Important factor in impedance calibration is correct connection of test cables between source of standard value (like M550 calibrator) and DUT. Four cables typically used for the connection have specific purpose and must not be swapped. M550 operation manual uses for description symbols H_{CUR} , H_{POT} , L_{POT} , L_{CUR} however some LCR meter manufacturers use different symbols. Table below shows equivalency of those commonly used symbols.

LCR meter / M550 terminal description	Symbol used in M550 operation manual	Another version used by some LCR meter manufacturers
High current source terminal	H_{CUR}	H_i, H_C
High voltage sense terminal	H_{POT}	H_u, H_P
Low voltage sense terminal	L_{POT}	L_u, H_P
Low current sense terminal	L_{CUR}	L_i, L_C

4.2. 4TP Four terminal pair standards

4.2.1. Internal partial standards description

4TP coaxial block consists of standards with coaxial connection of partial standards, coaxial SHORT and coaxial OPEN positions. The block contains resistance bank, capacitance bank and inductance bank. Resistance and capacitance partial standards are formed by single resistance and capacitance components. Only resistance value 100 M Ω is designed as simulator of T-resistance type:

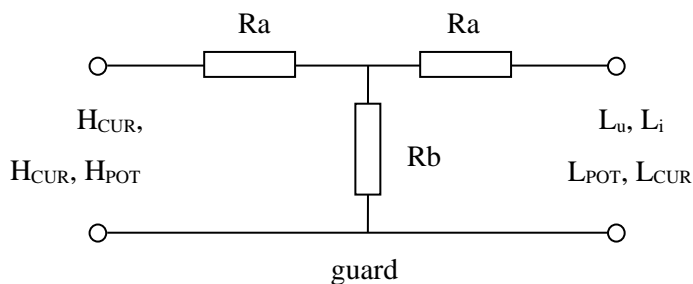

Figure 4 T resistance network

with simulated resistance $R_{21} = 2 \cdot R_a + R_a^2 / R_b$

Inductance bank does not contain any physical inductors. All inductance values are simulated using T network of RC type

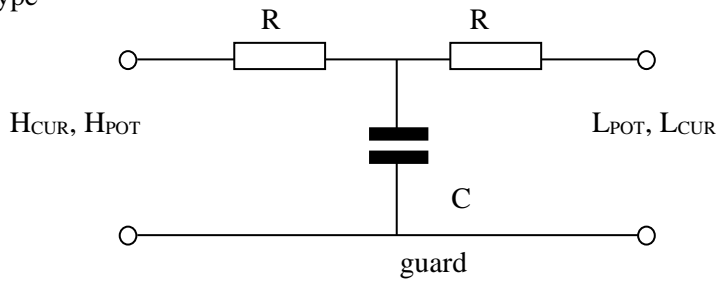

Figure 5 T inductance network

with simulated serial inductance value $L_{21} = C * R^2$ and quality factor $Q = \omega * C * R / 2$. Application of simulated inductance standards is limited to LCR meters which use four terminal pair technique (4TP).

Partial standards are connected to the output terminals using signal relays which switch both signal and shielding wire in all four terminals H_{CUR} , H_{POT} , L_{POT} , L_{CUR} . Coaxial connection of measuring traces inside the calibrator is made of coaxial PTFE 2 mm cable. Components are placed on printed circuit boards with RF strip line design. 4W/2W Two/four wire standards

4.2.2. Internal standards description

4W/2W non-coaxial block of standards consists of bank of resistors and a bank of capacitors. The 4W/2W block is fully separated from the coaxial 4TP block, except values 10 μ F and 100 μ F which are shared in both coaxial 4TP and non-coaxial 4W/2W modes. The 4W/2W block contains only two terminal partial standards. No method of simulation is applied.

4.3. Partial standard selection

Any of built-in partial standards can be connected to the output terminals and appropriate calibration data is displayed on the display.

L-C-R mode selection

After pressing one of the buttons R, C, L the calibrator switches to the selected mode resistance, capacitance or inductance, sets the last set-up standard and displays its calibration values. Whenever function is changed, calibrator remains with output terminals on until Output ON/OFF or Terminals selection button is pushed. Selected bank is indicated in top line of the display.

Partial standard selection

In any function and mode one of available partial standards can be chosen. Selection is possible in one of following ways:

- by typing nominal value of the requested standard from numeric keyboard. When non-correct value is entered, calibrator selects that standard which has the closest value to the entered value.
- using rotary button.

Push OPER button to connect the selected partial standard to the output terminals.

Displayed parameters setting

Use PARAM soft button to modify type of parameters pair to be displayed as calibration values. After pushing the PARAM button list of available parameter pairs is displayed in rolling window. Select requested pair using rotary button and confirm by pushing the soft button SELECT.

Frequency selection

Push the soft button **FREQ** to change frequency. Window for frequency entering appears.

- Type the requested frequency and confirm with soft button **Hz**, **kHz** or **MHz**. Calibration data is shown on the display. Output terminals will stay **ON** or **OFF** during changing the frequency depending on previous status. If frequency out of specified frequency range is entered calibrator will show error message “Frequency too high.” or “Frequency too low.”
- Another way of frequency setting is available using the rotary button. Push the rotary button. Arrows above and under the active position appear enabling to change the active position. Push the button again to set requested value.

4.4. Change of the bank mode 4TP to 4W/2W

4TP coaxial mode is setup as default after switching on. Partial standards are available on coaxial output terminals. Symbols in Auxiliary parameter window indicate position of these active output terminals. Push **4W/2W** button to switch over to 4W/2W mode. Switch **OPER** button. Now selected partial standard is connected to banana 4 mm terminals in 4W mode. Indicated position of the active terminals has been changed. Push the **4W/2W** button again. Calibrators goes over to 2W two wire mode. Auxiliary parameter window shows active terminals again.

4.5. Correction ON/OFF

Using **CORR** button calibration values of selected standard with or without correction can be displayed. Correction function is available for 4TP and 4W mode. 2W mode does not have this option.

When **CORR ON** mode is selected, calibrator shows calibration values relatively to internal reference positions **SHORT** and **OPEN**. When **CORR OFF** is selected, calibration values are defined in plane of output terminal and without any **SHORT/OPEN** compensations.

Push the button **CORR** to display calibration values with corrections. Symbol “corr” is attached to the main calibration value on the front panel display. Push the button **CORR** again to switch off corrections. Symbol “corr” disappears.

Open/Short/Load correction technique

Open/short/load compensation is an advanced compensation technique that can be applied to minimize influence of residual parameters. To carry out the open/short/load compensation, three measurements are required before measuring the DUT, with the test fixture terminals opened, shorted, and with a reference load connected to DUT. Follow instructions of LCR meter – DUT for correct compensation.

In the lower frequency region, using the open/short compensation function can minimize most of test lead residuals. In the RF region, practically for frequencies above 50 kHz however, this is not enough to reduce the effect of the test leads residuals. The wavelength of RF frequencies is short and is not negligible compared to the physical transmission line length of the test leads and calibrator internal connection. A phase shift induced error will occur as a result of the electrical length between DUT and partial calibrator standards. This error cannot be reduced by using open/short compensation. The phase shift can be compensated using **LOAD** correction.

Note: **LOAD** correction makes sense to use only if DUT – LCR meter is equipped with **LOAD** correction function.

There is no difference in connection between **CORR ON** and **CORR OFF** in M550. The only difference is in displayed calibration values.

Calibration values **CORR ON** and **CORR OFF** are often identical. Slight differences can be visible between the values especially at higher frequencies.

Relation between CORR ON and CORR OFF calibration values

Calibration values of type CORR ON and CORR can differ depending on type of partial standard connection mode (4TP, 4W, 2W) and frequency. The difference between these CORR ON and CORR OFF calibration values is given by influence in internal OPEN/SHORT reference position parameters and typical difference caused by electrical length of internal coaxial cabling.

Simplified equation shows the structure of difference:

$$Z_{\text{CORR OFF}} = Z_{\text{CORR ON}} + 1/Y_{\text{OPEN}} + Z_{\text{SHORT}} + Z_{\text{difference}}$$

Where	$Z_{\text{CORR OFF}}$	is by M550 calibrator calculated calibration value CORR OFF
	$Z_{\text{CORR ON}}$	is source calibration value saved in M550 calibration memory
	Y_{OPEN}	is residual admittance parameter of m550 reference position OPEN
	Z_{SHORT}	is residual impedance parameter of M550 reference position SHORT
	$Z_{\text{difference}}$	is typical difference of partial standard for CORR ON and CORR OFF mode.

4.6. SHORT/OPEN

SHORT and OPEN corrections are mostly applied compensations made in LCR meters to improve accuracy in low impedance range (SHORT) and high impedance range (OPEN).

To simplify calibration of LCR meters M550 calibrator is equipped with both of these reference positions enabling compensation without disconnection of DUT to M550. The positions can be selected by pushing the buttons OPEN or SHORT. Those output terminals are shorted or opened depending on which mode 4TP or 4W/2W is selected. Status of the calibrator is indicated by OPEN or SHORT label displayed on the display.

Residual parameters of OPEN/SHORT positions are specified in chapter Specification. OPEN and SHORT parameters are not specified in 2W mode.

Note: When OPEN or SHORT corrections are selected internal signal level meter readings are not available.

4.7. External input

The calibrator contains four additional BNC connector located on the rear panel. Using the connectors one external standard can be connected to the calibrator and through the calibrator to the front panel output terminals. The feature can be useful when a special value of standard is requested for automatic calibration of DUTs. Parameters of the external standard cannot be written and saved in the M550. Interconnection between rear panel coaxial connectors and front panel 4TP connector is arranged in four-terminal pair technique, i.e. both signal and shielding wires are switched separately for all four terminals.

4.8. Z/Y switch

Calibrator front panel display shows the selected partial standard calibration value at selected frequency and in selected pair of main parameters. Under the main parameters normalized calibration value is always displayed in exponential form either impedance $|Z| \cdot e^{j\theta}$ or admittance $|Y| \cdot e^{-j\theta}$. The Z/Y button enables to change indication from impedance to admittance form.

4.9. Meter operation

By pushing the button Meter ON in System buttons field internal voltmeter & counter can be temporarily activated to measure DUT test signal level. After pushing the button the meter is connected for approx. 5 second to the $H_{CUR} - L_{CUR}$ output terminals. During this time the meter measures a test signal level sourced from DUT - LCR meter and displays live readings of the measured frequency, test voltage, and evaluated test current. Measured values are displayed in red color. Frequency cannot be manually changed during this period. When the time interval has elapsed, readings are frozen, change color to blue and appropriate calibration values of the selected partial standard at frequency just measured are displayed. New test signal level and frequency measuring can be launched by pushing the ON button or new frequency can be entered manually.

Internal level meter always measures test signal on those output terminals which are selected in mode selection, either 4TP or 4W/2W terminals.

Meter function can be disabled using METER item in the main setup menu.

Note: Calibration values of a selected partial standard shown on the display are not valid during period when meter is connected to the output terminals. Meter nominal input impedance is 100 k Ω .

4.10. Local/Remote operation

By pushing the LOCAL button the calibrator can be switched over to local control mode while in remote mode.

5. Calibration example

5.1. LCR meter calibration with four terminal pair connection (4TP)

The four-terminal pair method is applied in many LCR meters which use coaxial inputs. It solves problems with mutual coupling among test cables. The reverse test current flows through shielding of the current coaxial cables and so it eliminates an effect of the magnetic flow, arising as measuring current flow through inner current conductors sequence. The function of individual connectors on calibrator side and on checked LCR meter as well is un-exchangeable.

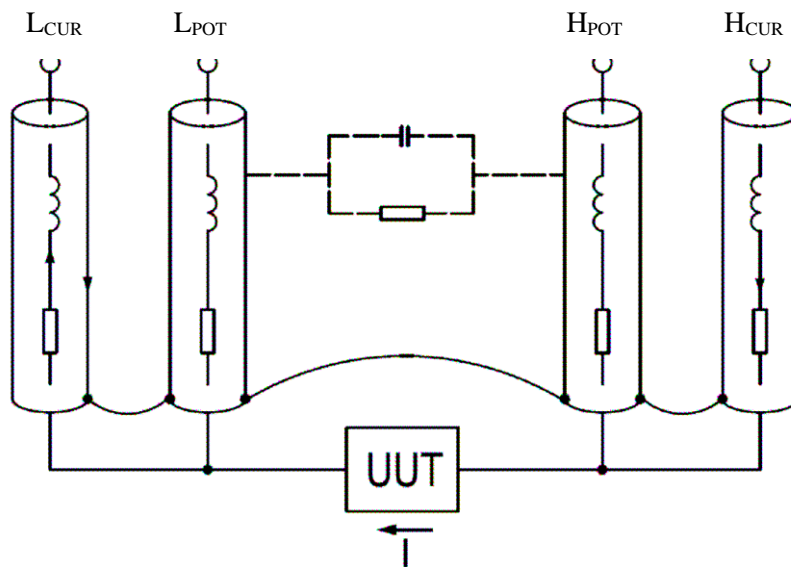

Figure 6 Principle of 4TP test lead connection

The 4TP measurement circuit outer conductors of instrument's H_{CUR} , H_{POT} , L_{POT} , and L_{CUR} terminals are isolated. By connecting the outer shielding conductors to each other at the ends of the coaxial cables, the current loop is formed. The test signal current flows through the inner conductor of the H_{CUR} cable, to the DUT, and the inner conductor of L_{CUR} cable, and then returns to signal source through the outer shielding conductors of the L_{CUR} and H_{CUR} cables. Since the same current flows in opposite directions through the inner and outer conductors of the coaxial cables, the magnetic flux generated by the inner conductor is cancelled out by that of the outer shielding conductor, as shown in Figure 3-8 (e). As a result, the mutual coupling problem is eliminated. The 4TP configuration can improve the impedance measurement range to below 1 m Ω . The measurement range achieved by this configuration depends on how well the 4TP configuration is strictly adhered to up to the connection point of the DUT.

Use four coaxial test leads to connect Impedance calibrator to unit under test, see figure. 7.

Note: Shielding conductors of the coaxial test cables must be connected neither to each other nor to ground potential GND. If the shielding conductors are not interconnected properly, accurate loop current does not flow through the cables and, as a result, the measurement range will be limited, or in some cases, measurements cannot be made.

Shielding conductors of the front panel BNC connectors are interconnected inside the calibrator. Do not allow any other connection of the shielding conductors!

Some types of LCR meters and LF impedance analysers do not meet requirements of four terminal pair principle, especially in connection of shielding conductors. This can result in unexpected deviations of impedance measurements on higher frequencies, typically above 100 kHz.

Non correct interconnection of the coaxial test cables results in sensitivity of mutual position of all four test cables to result of measurement, typically at frequencies above 100 kHz.

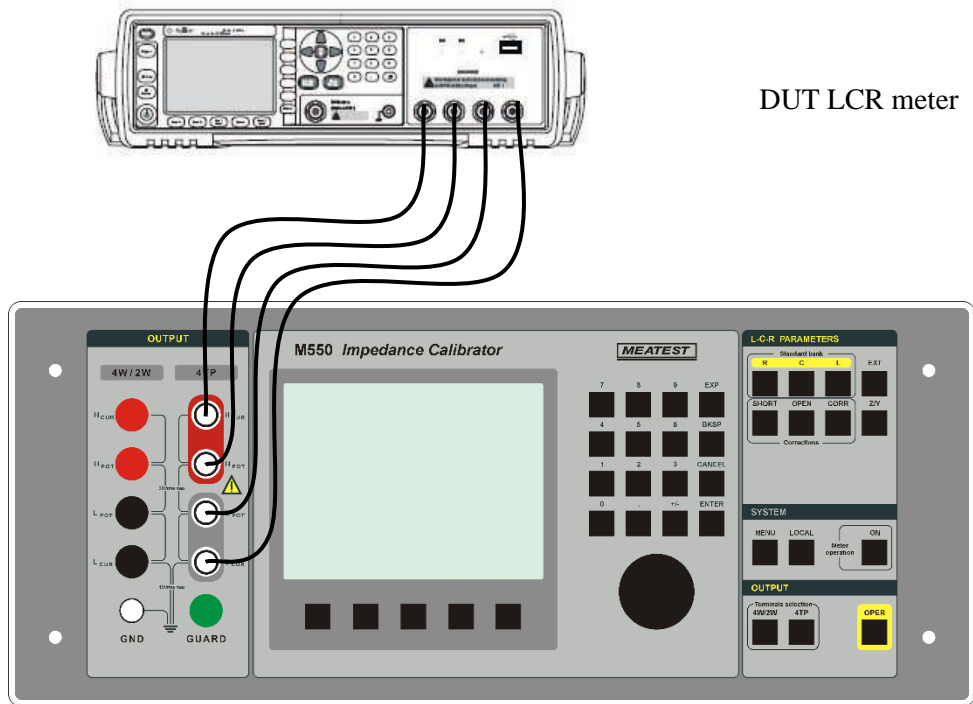

Figure 7 DUT connection in 4TP mode

4TP technique is mostly used in modern LCR meters. Typical feature is 4 coaxial input terminals usually labeled H_i (or H_{CUR}), H_u (of H_{POT}), L_u (or L_{POT}), L_i (or L_{CUR}).

Example of LCR meters with four terminal pair connection:

- HP/Agilent 4263B, 4268A, 4275A, 4274A, 4284A, 4276A, 4277A, E4980A,
- WAYNE-KERR 3255B, 6425, 6430, 6440, 6450, 6500B

Application without SHORT/OPEN/LOAD corrections

1. Connect LCR meter to M550 calibrator using BNC-BNC coaxial cables from M550 accessory. Use M550 4TP output. Make sure to connect corresponding terminals (H_{CUR} , H_{POT} , L_{POT} , L_{CUR}) correctly.
2. Select requested frequency, test level and parameters in DUT LCR meter
3. Select 4TP mode in M550 using 4TP button.
4. Select requested bank of standards using R, L, C buttons
5. Select requested partial standards using either rotary button or numerical keypad
6. Select requested pair of parameters and frequency in M550. Optionally, use test signal level meter to measure test frequency, see chapter 5.4. for details.
7. Push OPER button to switch the output terminals ON.
8. Compare reading of DUT with displayed calibration values in M550 calibrator.

Application of SHORT/OPEN/LOAD corrections

When calibration with SHORT/OPEN/LOAD corrections is requested perform before measurements the corrections:

1. SHORT / OPEN correction
 - a) Push SHORT or OPEN button on M550 calibrator. M550 display shows SHORT or OPEN label.
 - b) Push OPER button to switch M550 output terminals ON.
 - c) Use instructions in DUT operation manual to make SHORT or OPEN correction.
2. LOAD correction
 - f) Perform LOAD correction of DUT if it is equipped with it. Follow instructions described in DUT operation manual.

5.2. LCR meter calibration with four terminal connection (4W)

4W connection is mostly used in older LCR meters. They have typically four non-shielded banana terminals on the front panel. Accuracy of these meters is obviously worse than an accuracy of 4TP meters and frequency range is limited to approx. 1 kHz.

The four-terminal method reduces substantially influence of test cables between the Impedance calibrator and DUT. The four-terminal connection is suitable to use from impedance values about 1Ω . When measuring on lower impedance values the result of calibration can be distorted by mutual feedback between current and voltage conductors, especially in mode when higher measuring current is used. The impedance calibrator is connected by four standard cables. This connection is not suitable for measuring with frequency higher than 1 kHz. However even at lower measuring frequency use it is suitable to ensure minimum feedback among current and voltage conductors. At measuring values lower than 100Ω it is recommended to twist both current $L_{CUR} - H_{CUR}$ and both voltage $L_{POT} - H_{POT}$ cables, at measuring of values over 100Ω cables $L_{POT} - L_{CUR}$ and $H_{POT} - H_{CUR}$.

Four wire and two wire connection has limited capabilities to avoid stray parameters, and influence of test lead.

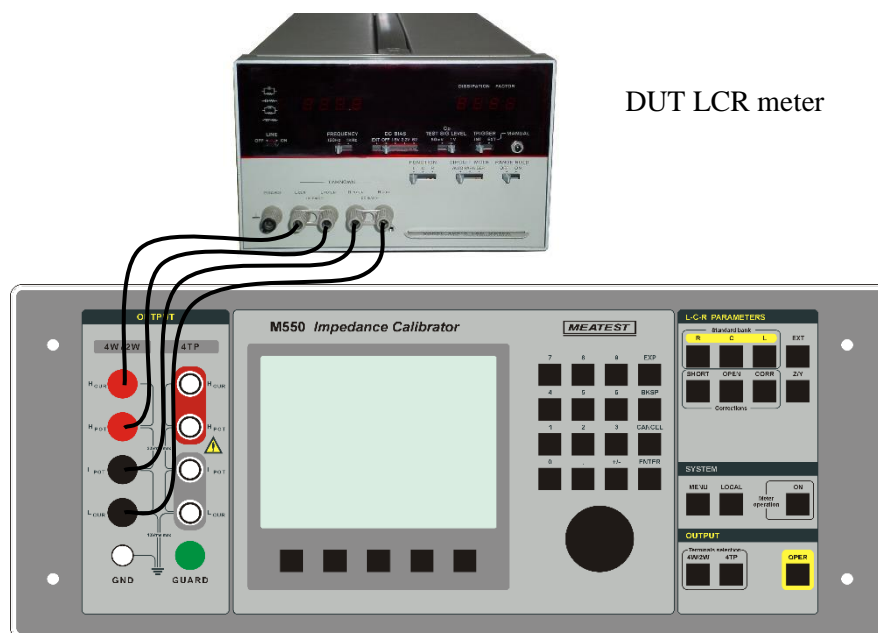

Figure 8 Four wire connection

1. Connect LCR meter to M550 calibrator using banana-banana test cables. Use M550 4W/2W output. Make sure to connect corresponding terminals (H_{CUR} , H_{POT} , L_{POT} , L_{CUR}) correctly.
2. Select requested frequency, test level and parameters in DUT LCR meter
3. Select 4W mode in M550 using 4W button.
4. Select requested bank of standards using R, L, C buttons
5. Select requested partial standards using either rotary button or numerical keypad
6. Select requested pair of parameters and frequency in M550. Optionally, use test signal level meter to measure test frequency, see chapter 5.4. for details.
7. Push OPER button to switch the output terminals ON.
8. Compare reading of DUT with displayed calibration values in M550 calibrator.

When calibration with correction SHORT/OPEN are requested perform it before measurement:

SHORT / OPEN correction:

1. Push SHORT or OPEN button in M550 calibrator. M550 display shows SHORT or OPEN label.
2. Push OPER button to switch M550 output terminals ON.
3. Use instructions in DUT operation manual to make SHORT or OPEN correction.

5.3. LCR meter calibration with two terminal connection (2W)

This way of the Impedance calibrator connection to the tested LCR meter is the simplest method however it is influenced by a lot of factors resulting in worse accuracy comparing to four-terminal or four terminal pair method. To the measurement result there are added errors by series resistance and inductance of test leads and parallel capacity and conductance between the two leads. The two-terminal connection is normally applied only in case when a high accuracy of calibration is not required. The calibrator is connected by single test leads to the H_{CUR} and L_{CUR} terminals. M550 calibration data does not offer residual parameters correction (OPEN and SHORT) at all in this mode. Partial standards are suitable for application only bellow 1 kHz.

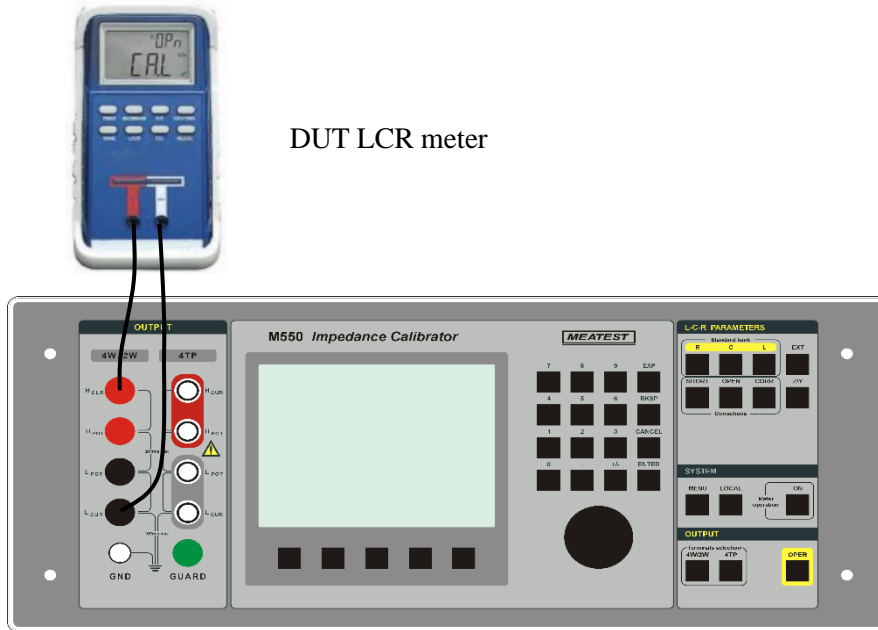

Figure 9 Two wire connection

1. Connect LCR meter to M550 calibrator using two banana-banana test cables. Use M550 4W/2W output. Make sure to connect corresponding terminals (H_{CUR} , L_{CUR}) correctly.
2. Select requested frequency, test level and parameters in DUT LCR meter
3. Select 2W mode in M550 using 4W/2W button.
4. Select requested bank of standards using R, L, C buttons, parameter pair and frequency
5. Push OPER button to switch the output terminals ON.
6. Compare reading of DUT with displayed calibration values in M550 calibrator.

Note: Correction function and reference positions SHORT/OPEN are not available in 2W mode.

5.4. Application of signal level meter

Test signal voltage and frequency can be measured directly when M550 meter of test signal level meter is activated. Activation can be setup in SETUP menu.

1. Push the button METER ON. M550 starts to measure test signal.
2. Test voltage line on M550 display becomes red indicating in this way that test signal level measurement is in process. Live reading of M550 level meter and counter is displayed. The measurement takes about 5 seconds.
3. When measurement is finished displayed values of frequency, test voltage and test current are frozen and calibration data corresponding to measured frequency are displayed automatically.
4. If test signal voltage is not high enough (over 200 mV) or frequency is out of meter range (above 100 kHz), instead of meter readings symbol “----” is displayed showing that meter could not make successful measurement. Test frequency value is returned to the original value before measuring had started.
5. New measurement of test level and frequency can be launched or another frequency can be entered manually using FREQ soft button numerical keypad.
- 6.

Note: M550 output terminals are loaded with 100 k Ω resistor during process of measurement. DUT can display non-correct readings during this time.

Test signal level meter works in frequency range band 20 Hz to 100 kHz and for test voltage higher than 200 mV_{rms}. When calibrating low impedance values, test current sourced by DUT may not create enough high voltage on selected standard to be measured by M550 calibrator.

Anytime frequency can be set up manually except period when meter is proceeding measurement.

6. Performance verification

Specifications of this calibrator are defined for 1 year period so it should be periodically tested (and adjusted if necessary) within the same period of time.

Ensure the calibrator has been in a temperature suitable environment for at least one hour before starting the verification process.

If you don't have the necessary equipment or can't do the calibration on your own, please ask local Meatest representative to help you calibrate this device.

6.1. Required equipment

Following instruments are required for performance verification test:

- Standard LCR meter with accuracy 0.05 % like Wayne Kerr 6440B or Agilent E4980A
- Standard 8 1/2 digit multimeter like Agilent 3458A or Fluke 8508A

Verification procedure is based on direct measurement of the partial bank using standard meter.

6.2. Verification procedure

Resistance standard - 4TP output

Connect standard multimeter to the M550 4TP output terminals. Use terminal adapters BNC/banana. Use four terminal connection, set the most accurate mode of four terminal resistance measurement in the multimeter, TRUE RMS mode

Set 4TP mode and Correction ON in M550.

Set SHORT position in M550 and make ZERO correction in the standard multimeter.

Measure the partial resistance bank of the M550 from 100 mΩ to 10 MΩ.

Connect standard LCR meter to the M550 output terminals. Use four terminal coaxial connection. Set test frequency 1 kHz, test voltage 1 V.

Set SHORT position in M550 and make SHORT correction in the standard LCR meter.

Set OPEN position in M550 and make OPEN correction in the standard LCR meter.

Set position 100 MΩ in M550 calibrator.

Measure the value using standard LCR meter

Measured values should be within limits as follows:

Nominal value	Resistance limits	Standard	Test frequency
0.1 Ω	$R_{cal} \pm 0.0002 \Omega$	8 ½ dig multimeter	DC
1.0 Ω	$R_{cal} \pm 0.001 \Omega$	8 ½ dig multimeter	DC
10 Ω	$R_{cal} \pm 0.005 \Omega$	8 ½ dig multimeter	DC
100 Ω	$R_{cal} \pm 0.02 \Omega$	8 ½ dig multimeter	DC
1 kΩ	$R_{cal} \pm 0.2 \Omega$	8 ½ dig multimeter	DC
10 kΩ	$R_{cal} \pm 2 \Omega$	8 ½ dig multimeter	DC
100 kΩ	$R_{cal} \pm 20 \Omega$	8 ½ dig multimeter	DC
1 MΩ	$R_{cal} \pm 300 \Omega$	8 ½ dig multimeter	DC
10 MΩ	$R_{cal} \pm 5000 \Omega$	8 ½ dig multimeter	DC
100 MΩ	$R_{cal} \pm 100000 \Omega$	LCR meter	1000 Hz

R_{cal} is R_s parameter calibration value at frequency 30 Hz, mode CORR ON

Table 14TP Resistance verification test

Capacitance standard - 4TP output

Connect standard LCR meter to the M550 4TP output terminals. Use four terminal coaxial connection. Set test frequency 1 kHz, test voltage 1 V.

Set SHORT position in M550 and make SHORT correction in the standard LCR meter.

Set OPEN position in M550 and make OPEN correction in the standard LCR meter.

Set partial capacitance bank step by step and measure both complex parameter Cp and D.

Compare it with M550 calibration values at frequency 1 kHz. (C_{cal} is calibration value at frequency 1 kHz).

Nominal value	Cp Capacitance limits	Dissipation factor limits	Standard	Test frequency
10 pF	$C_{cal} \pm 0.05 \text{ pF}$	< 0.0020	LCR meter	1000 Hz
100 pF	$C_{cal} \pm 0.1 \text{ pF}$	< 0.0010	LCR meter	1000 Hz
1 nF	$C_{cal} \pm 0.5 \text{ pF}$	< 0.0010	LCR meter	1000 Hz
10 nF	$C_{cal} \pm 5 \text{ pF}$	< 0.0010	LCR meter	1000 Hz
100 nF	$C_{cal} \pm 50 \text{ pF}$	< 0.0010	LCR meter	1000 Hz
1 μF	$C_{cal} \pm 500 \text{ pF}$	< 0.0010	LCR meter	1000 Hz
10 μF	$C_{cal} \pm 5 \text{ nF}$	< 0.0050	LCR meter	1000 Hz
100 μF	$C_{cal} \pm 100 \text{ nF}$	< 0.0200	LCR meter	1000 Hz

C_{cal} is C_p calibration value, mode CORR ON

Table 2 4TP Capacitance verification test

Inductance standard - 4TP output

Set partial inductance bank step by step and measure both complex parameter Ls and Rs at frequencies signed in the table below.

Compare it with M550 calibration values at signed frequency (L_{cal} is calibration value at signed frequency).

Nominal value	Rs Inductance limits	Rs typical value	Standard	Test frequency
10 μH	$L_{cal} \pm 0.1 \text{ } \mu\text{H}$	66 Ω	LCR meter	50 kHz
100 μH	$L_{cal} \pm 0.2 \text{ } \mu\text{H}$	200 Ω	LCR meter	50 kHz
1 mH	$L_{cal} \pm 1.0 \text{ } \mu\text{H}$	660 Ω	LCR meter	50 kHz
10 mH	$L_{cal} \pm 10 \text{ } \mu\text{H}$	660 Ω	LCR meter	10 kHz
100 mH	$L_{cal} \pm 100 \text{ } \mu\text{H}$	2 000 Ω	LCR meter	10 kHz
1 H	$L_{cal} \pm 1.0 \text{ mH}$	20 000 Ω	LCR meter	1 kHz
10 H	$L_{cal} \pm 10 \text{ mH}$	20 000 Ω	LCR meter	100 Hz

L_{cal} is L_s parameter calibration value at signed frequency, mode CORR ON

Table 3 4TP Inductance verification test

Resistance standard - 4W output

Connect standard multimeter to the M550 4/2W output terminals. Use four single banana-banana test leads.

Connect them as follows:

Standard multimeter	M550
V	H _{CUR}
COM	L _{CUR}
+ SENSE	H _{POT}
- SENSE	L _{POT}

- Use four terminal connection, set the most accurate mode of four terminal resistance measurement in the multimeter, TRUE RMS mode
- Set 4W mode in M550.
- Set SHORT position in M550 and make ZERO correction in the standard multimeter.
- Measure partial resistance standards of the M550 from 100 mΩ to 100 MΩ.
- Measured values should be within limits in table XIV.

Nominal value	Resistance limits	Standard	Test frequency
0.1 Ω	R _{cal} +/- 0.000 5 Ω	8 ½ dig multimeter	DC
1.0 Ω	R _{cal} +/- 0.001 Ω	8 ½ dig multimeter	DC
10 Ω	R _{cal} +/- 0.005 Ω	8 ½ dig multimeter	DC
100 Ω	R _{cal} +/- 0.05 Ω	8 ½ dig multimeter	DC
1 kΩ	R _{cal} +/- 0.2 Ω	8 ½ dig multimeter	DC
10 kΩ	R _{cal} +/- 2 Ω	8 ½ dig multimeter	DC
100 kΩ	R _{cal} +/- 100 Ω	8 ½ dig multimeter	DC
1 MΩ	R _{cal} +/- 1 kΩ	8 ½ dig multimeter	DC
10 MΩ	R _{cal} +/- 2 kΩ	8 ½ dig multimeter	DC
100 MΩ	R _{cal} +/- 1 MΩ	8 ½ dig multimeter	DC

R_{cal} is R_s parameter calibration value at 1 kHz, mode CORR ON.

Table 4 4W Resistance verification test

Capacitance standard - 4W output

Connect standard LCR meter to the M550 4/2W output terminals. Use four terminal Kelvin cable adapter from standard LCR meter accessory. Connect the clips to H_{CUR} , H_{POT} and L_{POT} , L_{CUR} terminals. When autobalance bridge is applied for 4W verification, connect standard LCR meter terminals to M550 4/2W output according to following picture.

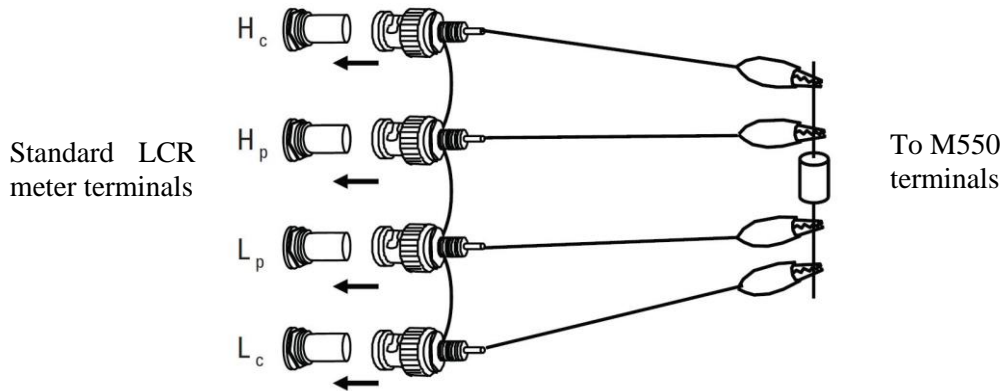

Figure 10 Standard LCR meter connection for 4W capacitance standard verification

- Set test frequency 1 kHz, test voltage 1 V.
- Set 4W mode in M550
- Set SHORT position in M550 and make SHORT correction in the standard LCR meter.
- Set OPEN position in M550 and make OPEN correction in the standard LCR meter.
- Set partial capacitance standards step by step and measure both complex parameter C_p and D .
- Compare it with M550 calibration values at frequency 1 kHz:

Nominal value	C_p Capacitance limits	Standard	Test frequency
100 pF	$C_{cal} \pm 1 \text{ pF}$	LCR meter	1000 Hz
1 nF	$C_{cal} \pm 1 \text{ pF}$	LCR meter	1000 Hz
10 nF	$C_{cal} \pm 5 \text{ pF}$	LCR meter	1000 Hz
100 nF	$C_{cal} \pm 50 \text{ pF}$	LCR meter	1000 Hz
1 μF	$C_{cal} \pm 500 \text{ pF}$	LCR meter	1000 Hz
10 μF	$C_{cal} \pm 10 \text{ nF}$	LCR meter	1000 Hz
100 μF	$C_{cal} \pm 200 \text{ nF}$	LCR meter	1000 Hz

C_{cal} is C_p calibration value at frequency 1 kHz, mode CORR ON.

Table 5 4W Capacitance verification test

Resistance standard - 2W output

Connect standard multimeter to the M550 4/2W output terminals. Use four single banana - banana test leads. Connect them as follows:

Standard multimeter	M550
V	H _{CUR}
COM	L _{CUR}
+ SENSE	H _{CUR}
- SENSE	L _{CUR}

- Use four terminal connection, set the most accurate mode of four terminal resistance measurement in the multimeter, TRUE RMS mode.
- Set 2W mode in M550.
- Measure the partial resistance standards of the M550 from 1 Ω to 10 MΩ.
- Measured values should be within limits as follows (R_{cal} is calibration value at 1 kHz):

Nominal value	Resistance limits	Standard	Test frequency
1.0 Ω	R _{cal} +/- 0.05 Ω	8 ½ dig multimeter	DC
10 Ω	R _{cal} +/- 0.05 Ω	8 ½ dig multimeter	DC
100 Ω	R _{cal} +/- 0.1 Ω	8 ½ dig multimeter	DC
1 kΩ	R _{cal} +/- 1 Ω	8 ½ dig multimeter	DC
10 kΩ	R _{cal} +/- 10 Ω	8 ½ dig multimeter	DC
100 kΩ	R _{cal} +/- 100 Ω	8 ½ dig multimeter	DC
1 MΩ	R _{cal} +/- 2 kΩ	8 ½ dig multimeter	DC
10 MΩ	R _{cal} +/- 50 kΩ	8 ½ dig multimeter	DC

Table 6 2W Resistance verification test

Capacitance standard - 2W output

Connect standard LCR meter to the M550 4/2W output terminals. Use Kelvin cable adapter from standard LCR meter accessory. Connect the clips to H_{CUR} and L_{CUR} terminals. If the adapter is not available, use connection according to following picture.

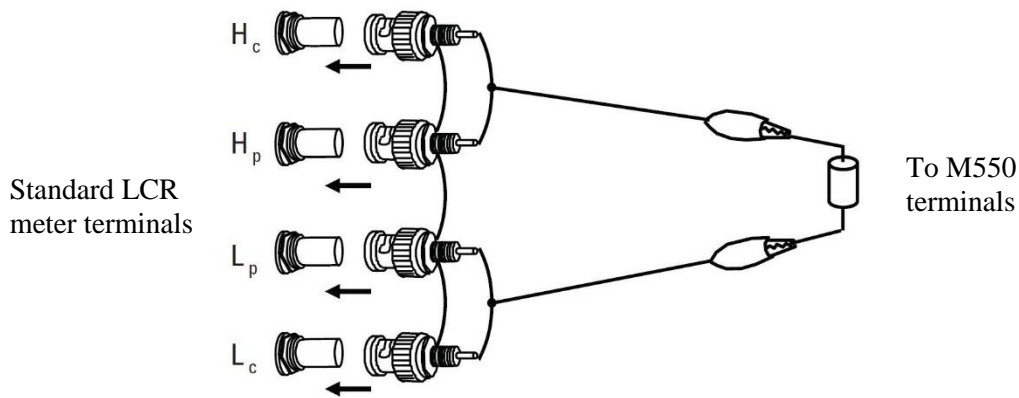

Figure 11 Standard LCR meter connection for 2W capacitance standard verification

- Set test frequency 1 kHz, test voltage 1 V.
- Set 2W mode in M550
- Set SHORT position in M550 and make SHORT correction in the standard LCR meter.
- Set OPEN position in M550 and make OPEN correction in the standard LCR meter.
- Set partial capacitance standards step by step and measure both complex parameter Cp and D.
- Compare it with M550 calibration values at frequency 1 kHz. (C_{cal} is calibration value at frequency 1 kHz).

Nominal value	Cp Capacitance limits	Standard	Test frequency
100 pF	C _{cal} +/- 5 pF	LCR meter	1000 Hz
1 nF	C _{cal} +/- 10 pF	LCR meter	1000 Hz
10 nF	C _{cal} +/- 20 pF	LCR meter	1000 Hz
100 nF	C _{cal} +/- 200 pF	LCR meter	1000 Hz
1 μF	C _{cal} +/- 2 nF	LCR meter	1000 Hz
10 μF	C _{cal} +/- 50 nF	LCR meter	1000 Hz
100 μF	C _{cal} +/- 1 000 nF	LCR meter	1000 Hz

Table 7 2W Capacitance verification test

7. Adjustment

The impedance calibrator requires periodical recalibration. Recommended recalibration interval is 1 year. The recalibration process is based on measuring of M550 partial standards using either direct method of measurement with standard LCR meter and standard multimeter or using comparison method with set of single standard resistors, capacitors and inductors of decimal nominal values and entering and saving new calibration values.

For recalibration purpose the calibrator includes calibration procedure. Recalibration can be performed using the front panel buttons and calibration menu.

Note: M550 partial standards cannot be re-adjusted.

7.1. Access to recalibration

Access to calibration function is protected with password. To enter the procedure:

- Push SETUP button and select CALIBRATION item in the list. Window for password entering appears.
- Write correct password and confirm using OK soft button.
- Menu with functions for recalibration appears

Note: default factory password is “55000”. The password can be modified in SETUP menu.

7.2. Recalibration structure

Basic calibration menu contains two items:

Discrete standards calibration	Proceed through this item to R, C, L partial standard calibration data. Discrete standard recalibration offers two methods, Full and Offset recalibration.
Meter calibration	Select this item when built in meter of test signal voltage is to be recalibrated.

7.2.1. Discrete standard calibration

Calibration structure consists of three calibration levels:

- Selection of type of calibration
- Selection of mode (type of connection) 4TP or 4W/2W and standard bank R or C or L
- Individual partial standard selection

I. level

Select either Full or Offset calibration.

- Full calibration

The item enables to modify both complex calibration values (primary and secondary) of all R, C, L partial standards, and reference positions SHORT/OPEN as well in spot frequencies. Any of calibration values can be modified and saved independently.

Spot frequencies is line of fix frequencies at which calibration data are defined. The line of spot frequencies is as follows:

30, 50, 100, 300, 500, 1 000, 3 000, 5 000, 10 000, 30 000, 50 000, 100 000, 300 000, 500 000, 1 000 000 Hz

- Offset calibration

The item enables to modify only main parameter (primary) of partial standard at 1 kHz frequency. When the parameter is changed, the deviation against original calibration value is calculated and with this deviation main parameter is shifted at all applicable spot frequencies. In memory stored frequency characteristic is not influenced.

Note: Not all spot frequencies may be accessible for all partial standards. See frequency range of partial standards to check valid frequency band.

It is recommended to prefer Offset calibration method to avoid unexpected change of the characteristic. Use Full calibration method only if you can measure frequency characteristic with appropriate accuracy.

II. level

Partial standards in one of three modes 4TP, 4W, 2W can be modified. List of items in this level is as follows:

- Resistance bank 4TP partial resistance standard calibration values in 4TP mode can be edited
- Capacitance bank 4TP partial capacitance standard calibration values in 4TP mode can be edited
- Inductance bank 4TP partial inductance standard calibration values in 4TP mode can be edited
- Resistance bank 4W partial resistance standard calibration values in 4W mode can be edited
- Capacitance bank 4W partial capacitance standard calibration values in 4W mode can be edited
- Resistance bank 2W partial resistance standard calibration values in 2W mode can be edited.
Only main parameter is defined in 2W mode
- Capacitance bank 2W partial capacitance standard calibration values in 2W mode can be edited.
Only main parameter is defined in 2W mode

III. level

The III level contains list of partial standards of selected bank in selected connection mode. The partial standards are identified with their nominal value. Select requested standard to enable editing calibration data. III. level is not available for OPEN and SHORT positions.

7.2.2. Signal level meter adjustment

Meter item serves for internal test signal level meter adjustment. Only voltage ranges can be adjusted. Frequency function has fix setting which cannot be changed. Accuracy of measurement of frequency is given by applied quartz oscillator.

Select item Meter calibration in basic calibration level. Following possibilities appears:

- Zero calibration
Access to calibration of zero point of voltage scale
- Full scale calibration
Access to recalibration of full-scale point.

7.2.3. History

M550 Impedance calibrator is equipped with memory of history of calibration values of partial standards. Calibrator records and keeps past calibration values of primary and secondary parameters at frequency 1 kHz. This is helpful tool for time stability of partial standards evaluation.

Access to the History is in Calibration section. Open Calibration system using correct password and select History. Select from the list of modes and list of partial standards that one you want to check. Calibration values of the selected standard will appear in form Table with following columns:

- Date of calibration
- Primary parameter value
- Secondary parameter value

10Ω		History	
Date	Rs	Ls	
11.06.2012	10.0023 Ω	6.0 nH	
05.01.2012	10.0022 Ω	6.0 nH	
28.06.2011	10.0020 Ω	6.0 nH	
13.01.2011	10.0019 Ω	6.0 nH	
04.08.2010	10.0018 Ω	6.0 nH	
16.01.2010	10.0016 Ω	6.0 nH	
23.06.2009	10.0015 Ω	6.0 nH	
14.01.2009	10.0014 Ω	6.0 nH	
03.06.2008	10.0013 Ω	6.0 nH	
22.01.2008	10.0013 Ω	6.0 nH	

Resistance bank 4TP

Next	Previous			Exit
------	----------	--	--	------

Figure 12 Calibration values history

Type of displayed primary and secondary parameter cannot be changed. For resistance standards pair R_s - L_s or R_p - C_p , for capacitance standards C_p - D and for inductance L_s - R_s parameter pair is always applied.

New calibration value is added to the history automatically if date of previous calibration of the selected standard is older than seven days. If new calibration is performed within next seven days after the last calibration, calibrator offers either to replace the last value with a new one or to append it.

Maximum number of stored calibration pairs is 30 records per standard. When maximum number is being crossed over during calibration, calibrator deletes the oldest calibration parameter pair and adds the newest one. Warning is displayed before deleting the old data with option to delete it or not to save the new calibration values.

7.3. Recalibration procedure

Use the procedure to change calibration values of any of partial standard. Switch the calibrator ON and leave it until warm up time has released. Connect it to appropriate output terminals standard LCR-meter.

7.3.1. OFFSET calibration method (preferred)

1. Push MENU button, select CALIBRATION item.
2. Select DISCRETE STANDARD CALIBRATION
3. Select OFFSET CALIBRATION in next step
4. Select type of bank (resistance, capacitance, inductance) and type of connection (4TP, 4W or 2W)
5. Select nominal value of partial standard which calibration values are requested to modify.
6. Screen with main parameter of selected standard at 1 kHz frequency will appear.
7. Push the OPER button. Use one of following method to define new calibration value:
 - a. Direct measurement method: Measure the selected partial standard using standard meter. For resistance standards from 0.1 Ω to 10 M Ω 8 1/2 digit multimeter in high precise mode can be applied. Use four-wire true ohm measurement mode. For standard 100 M Ω standard LCR meter should be applied.
 - b. Comparison method:
 - i. Measure the selected partial standard using standard meter.
 - ii. Disconnect standard meter and connect calibration standard of the same type and the same nominal value.
 - iii. Evaluate deviation of the standard meter by comparing its reading to calibration standard calibration values
 - iv. Correct values measured in point (i.) with the deviation evaluated in point (iii.).
8. Write new calibration value of the main parameter at 1 kHz frequency and confirm with WRITE soft button. New calibration values have been saved.
9. Push EXIT to select another partial standard.
10. When recalibration is finished, push EXIT button repetitively until calibration menu is left and main screen is displayed.

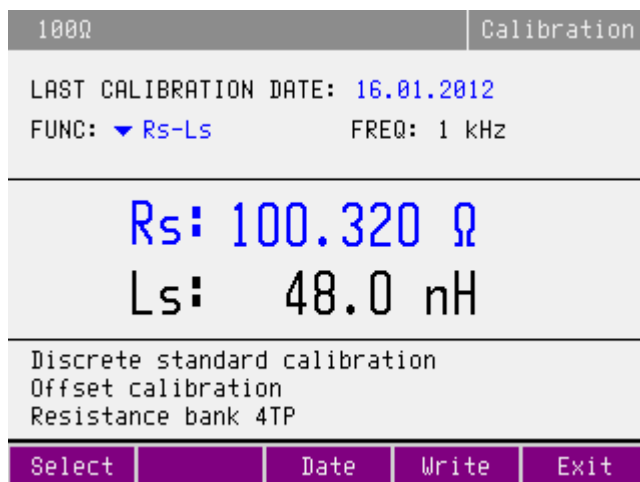

Figure 13 Offset calibration

Note: Secondary parameter is not available for editing in OFFSET calibration mode.

7.3.2. FULL calibration method

1. Push MENU button, select CALIBRATION item.
2. Select DISCRETE STANDARD CALIBRATION
3. Select FULL CALIBRATION in next step
4. Select type of bank (resistance, capacitance, inductance) and type of connection (4TP, 4W or 2W)
5. Select nominal value of partial standard which calibration values are requested to modify.
6. Screen with main parameter of selected bank of standard at default frequency will appear.
7. Select spot frequency from the list of available values using soft button FREQ and rotary button.
8. Select pair of complex parameters in which the new calibration values will be entered.
9. Push the OPER button. Use one of following method to define new calibration value:
 - a. Direct measurement method: Measure the selected partial standard using standard mean of measurement.
 - b. Comparison method:
 - i. Measure the selected partial standard using standard LCR meter.
 - ii. Disconnect standard LCR meter and connect it to single calibration standard of the same type and the same nominal value.
 - iii. Evaluate deviation of the standard LCR meter by comparing its reading to calibration standard calibration values
 - iv. Correct values measured in point (i.) with the deviation evaluated in point (iii.).
10. Enter new calibration values either both complex parameters or any of them, and confirm with soft button WRITE. New calibration values have been saved.
11. Select another spot frequency and edit calibration values. If another partial standard or another bank or another type of connection is to be calibrated go back in calibration level structure using soft button EXIT.
12. When recalibration is finished, push EXIT button repetitively until calibration menu is left and main screen is displayed.

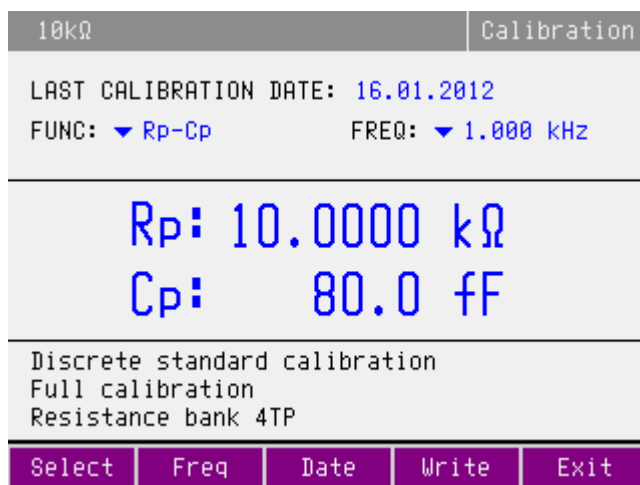

Figure 14 Full calibration

Note: Calibration process can be interrupted in any point of the calibration procedure. New calibration values are saved in memory always after pushing the soft button Write.

Frequency dependency of partial standards has been calibrated during production. It is given mostly by design of internal blocks and applied components. Don't do calibration of secondary values if it is really not necessary.

7.3.3. Signal level meter calibration

1. Select 4TP mode. Use BNC-banana adapters. Switch output terminals ON
2. Make short between $H_{CUR} - L_{CUR}$ terminals
3. Push MENU button, select CALIBRATION item.
4. Select METER CALIBRATION
5. Select ZERO CALIBRATION
6. Screen with ZERO point calibration appears. Live reading of internal voltmeter in digits is displayed. Push the WRITE soft button to save ZERO calibration value.
7. Push EXIT to go over to previous level.
8. Select item FULL SCALE CALIBRATION.
9. Screen with FULL SCALE point calibration appears. Live reading of internal voltmeter in digits is displayed.
10. Connect multifunction calibrator voltage output to $H_{CUR} - L_{CUR}$ coaxial terminals.
11. Set amplitude 5Vrms, frequency 1 kHz. Calibrator display shows reading of input AC voltage in digits.
12. Push the WRITE soft button to save FULL SCALE calibration value.
13. When recalibration is finished, push EXIT button repetitively until calibration menu is left and main screen is displayed.

8. Maintenance

This chapter explains how to perform the routine maintenance to keep your device in optimal operating conditions.

8.1. Fuse replacement

Replace the fuses as follows:

- Unplug the power cord from the Calibrator.
- Locate the fuse holder which is a part of power line entry module on the rest panel. Of the calibrator.
- Inserting a flat-blade screwdriver in the slot in the end of the fuse holder, remove the fuse holder from the module.
- Replace the fuse with the same type rated for the selected line voltage 230 V - F 400 mA.
- Reinsert the fuse holder.

8.2. Exterior cleaning

To keep the device in mint condition, clean the case and front panel keys using a soft cloth slightly dampened with either water or a non-abrasive mild cleaning solution that is not harmful to plastics.

8.3. Air filter cleaning

The air filter should be removed and cleaned at least every year, or more frequently if the calibrator is operated in a dusty environment. The air filter is accessible from the rear panel of the calibrator.

To clean the air filter, proceed as follows:

1. Unplug all connections to the front panel of the Calibrator.
2. Unplug the power cord from the Calibrator.
3. Remove the filter by grasping the outside edges of the filter and pulling straight out.
4. Remove the filter element from the filter frame.
5. Clean the filter by washing it in soapy water. Rinse and dry the filter element thoroughly before reinstalling.
6. Reinstall the filter element into the filter frame.
7. Snap the filter frame back on to the fan housing.

8.4. Error messages

The following table lists an overview of error codes that you might come across when operating the calibrator:

Message	Description
Function is not available	The selected function is not available in the calibrator.
Value too low	Attempt to setup lower value then is specified range. Set value within specified limits.
Value too high	Attempt to setup higher value then is specified range. Set value within specified limits.
Turn output terminals ON	Output terminals are OFF while test level meter has been activated. Turn the output terminals ON.
Wrong password	Non-correct password has been entered in calibration mode. Enter correct calibration password.
Function METER is OFF	The message will occur when test signal level meter is set to OFF in SETUP menu and F/U button is pushed to activate measuring. Select position ON in SETUP menu before activating the level meter.

Table 8 Error message description

9. Specifications

Bellow shown accuracy is valid after specified warm-up time in temperature range 23 ± 2 °C. The accuracy includes long-term stability, temperature coefficient, linearity, load and line regulation and the traceability of factory and National calibration standards. Specified accuracy is valid for one year after the last calibration. Specified accuracy „of range“ are related to the maximal value which can be set on the range.

General data

Interface	RS232, GPIB
Reference conditions:	23 +/- 2 °C, RH < 80%
Operating temperatures:	15 to 30 °C
Storage temperatures:	-10 to +55 °C
Power line:	115/230 V – 50/60 Hz
Power consumption:	35 VA
Warm up time:	15 minutes
Dimension :	450 (W) x 430 (D) x 150 (H) mm
Weight	12 kg
Power line:	110/115/120/125 - 220/230 V – 50/60 Hz
Safety class:	I according to EN 1010-1
Used external fuses:	T500mL250V for 230 VAC power supply voltage, 1 pc T1L250V for 115 VAC power supply voltage, 1 pc
Modes:	4TP four terminal pair R/L/C coaxial output for coaxial four terminal and four terminal pair applications 4W four terminal R/C non-coaxial for four wire applications 2W two terminal R/C non-coaxial for two wire applications
Output terminals	4 x BNC connectors for coaxial output (4TP) 4 x banana terminal for non-coaxial output (4W/2W)
Frequency range	20Hz to 1 MHz
Reference positions:	SHORT, OPEN

9.1. Resistance

Range	0.1 Ω to 100 M Ω	fix decimal values in 4TP mode
	0.1 Ω to 100 M Ω	fix decimal values in 4W mode
	1 Ω to 10 M Ω	fix decimal values in 2W mode
Deviation to nominal value	0.05 % to 10 % depending on value, mode and frequency	
Calibration uncertainty	0.02 % to 2 % at 1 kHz depending on value and mode	
Temperature coefficient	2 to 25 ppm/ $^{\circ}$ C	
Displayed parameter pairs	Z/ θ , Y/ θ , R _s /L _s , R _s /C _s , R _p /C _p , R _p /L _p , R/X, G/B	

9.2. Capacitance

Range	10 pF to 100 μ F	fix decimal values in 4TP mode
	10 pF to 100 μ F	fix decimal values in 4W mode
	100 pF to 100 μ F	fix decimal values in 2W mode
Deviation to nominal value	< 5%	
Calibration uncertainty	0.05 % to 5.0 % at 1 kHz depending on value and mode	
Temperature coefficient	30 to 100 ppm/ $^{\circ}$ C	
Displayed parameter pairs	Z/ θ , Y/ θ , C _s /D, C _s /R _s , C _p /D, C _p /R _p , C _p /G	

9.3. Inductance (simulated in 4TP mode only)

Range	10 μ H to 10 H	fix decimal values in 4TP mode
Deviation to nominal value	< 15 %	
Calibration uncertainty	0.15 % to 4.0 % at 1 kHz depending on value and mode	
Temperature coefficient	50 ppm/ $^{\circ}$ C	
Displayed parameter pairs	Z/ θ , Y/ θ , L _s /Q, L _s /R _s	

9.4. Test level meter

Displayed values	frequency, test voltage, test current
Frequency range	20 Hz to 100 kHz
Test frequency resolution	6 digit
Test frequency accuracy	0.01% +1 mHz
Test voltage range	200 mV to 10 V rms
Test voltage resolution	4 digits
Test voltage accuracy	5 % in range 200 mV – 1 V 2 % in range 1 V – 10 V
Test current range	1 nA to 500 mA
Test current resolution	4 digits
Test current accuracy	not specified

9.5. 4TP Resistance standards (coaxial output)

Stability and working parameters

Nominal value of serial resistance	1 year stability (typical)	Maximal deviation to nominal value at 1 kHz	Temperature coefficient T_k (maximal)	Max. test Voltage / Current
0.10000 Ω	0.001 %	2.00 %	0.0050 %/°C	200 mA
1.00000 Ω	0.001 %	1.00 %	0.0002 %/°C	100 mA
10.0000 Ω	0.001 %	0.50 %	0.0002 %/°C	50 mA
100.000 Ω	0.001 %	0.10 %	0.0002 %/°C	15 mA
1.00000 k Ω	0.001 %	0.10 %	0.0002 %/°C	5 V
10.0000 k Ω	0.001 %	0.10 %	0.0002 %/°C	15 V
100.000 k Ω	0.001 %	0.10 %	0.0002 %/°C	30 V
1.00000 M Ω	0.003 %	0.10 %	0.0002 %/°C	30 V
10.0000 M Ω	0.010 %	0.20 %	0.0010 %/°C	30 V
100.000 M Ω ¹	0.010 %	1.00 %	0.0050 %/°C	30 V

1. Simulation using T resistance network, nominal resistance values 10M Ω – 1.25M Ω – 10M Ω

Frequency flatness with OPEN/SHORT/LOAD correction^{2 *3 *4}

Nominal value of serial resistance	Max. resistance deviation			
	1 kHz to DC	10 kHz to DC	100 kHz to DC	1 MHz to DC
0.10000 Ω	0.02 %	0.10 %	--	--
1.00000 Ω	0.01 %	0.02 %	0.50 %	--
10.0000 Ω	0.01 %	0.01 %	0.10 %	0.50 %
100.000 Ω	0.01 %	0.01 %	0.02 %	0.50 %
1.00000 k Ω	0.01 %	0.01 %	0.02 %	0.50 %
10.0000 k Ω	0.01 %	0.01 %	0.02 %	0.70 %
100.000 k Ω	0.01 %	0.01 %	0.02 %	1.00 %
1.00000 M Ω	0.01 %	0.01 %	0.03 %	--
10.0000 M Ω	0.05 %	0.10 %	--	--
100.000 M Ω ⁵	0.02 %	2.00 %	---	--

2. Parameters are valid when OPEN/SHORT calibration is performed in DUT using OPEN/SHORT positions from the M550 calibrator before calibration. Parameters are valid when applied coaxial test cables delivered with the calibrator, length 50 cm.

3. Serial resistance is specified. Frequency deviations are related to DC reference value.

4. The table shows maximal frequency dependency of partial standards. See calibration values in M550 for exact value.

5. Simulation using T resistance network, nominal resistance values 10M Ω – 1.25M Ω – 10M Ω

Frequency flatness without OPEN/SHORT/LOAD correction ^{6,7,8}

Nominal value of serial resistance	Max. resistance deviation			
	1 kHz to DC	10 kHz to DC	100 kHz to DC	1 MHz to DC
0.10000 Ω	0.10 %	4.00 %	--	--
1.00000 Ω	0.05 %	0.20 %	5.00 %	--
10.0000 Ω	0.01 %	0.05 %	0.20 %	1.00 %
100.000 Ω	0.01 %	0.01 %	0.03 %	1.00 %
1.00000 kΩ	0.01 %	0.01 %	0.05 %	1.00 %
10.0000 kΩ	0.01 %	0.01 %	0.03 %	1.50 %
100.000 kΩ	0.01 %	0.01 %	0.10 %	--
1.00000 MΩ	0.01 %	0.02 %	1.00 %	--
10.0000 MΩ	0.05 %	4.00 %	--	--
100.000 MΩ ⁹	0.20 %	5.00 % ¹⁰	--	--

6. Specification is valid without performing OPEN/SHORT corrections. Calibration values are valid in plane of M550 calibrator coaxial output terminals

7. Serial resistance is specified. Frequency deviations are related to DC reference value.

8. The table shows maximal frequency dependency of partial standards. See calibration values in M550 for exact value.

9. Simulation using T resistance network, nominal resistance values 10MΩ – 1.25MΩ – 10MΩ

10. Specified to 5 kHz.

Resistance calibration value uncertainty [%] with correction off ¹¹

Standard (Ω)	0.1	1	10	100	1k	10k	100k	1M	10M	100M
Frequency [Hz]	Calibration uncertainty [%]									
20 – 199	0,30	0,10	0,05	0,05	0,02	0,02	0,02	0,03	0,05	0,10
200 – 399	0,30	0,10	0,05	0,05	0,02	0,02	0,02	0,03	0,05	0,20
400 – 749	0,30	0,10	0,05	0,05	0,02	0,02	0,02	0,03	0,05	0,50
750 – 1 999	0,30	0,10	0,05	0,05	0,02	0,02	0,02	0,03	0,05	1,00
2 000 – 3 999	0,50	0,10	0,05	0,05	0,02	0,02	0,02	0,03	0,05	2,00
4 000 – 5 000	1,00	0,10	0,05	0,05	0,02	0,02	0,02	0,03	0,10	3,00
5 001 – 7 499	1,00	0,10	0,05	0,05	0,02	0,02	0,02	0,03	0,10	--
7 500 – 10 000	4,00	0,15	0,05	0,05	0,02	0,02	0,05	0,05	0,50	--
10 001 – 19 999	--	0,15	0,05	0,05	0,02	0,02	0,05	0,05	--	--
20 000 – 39 999	--	0,20	0,07	0,05	0,02	0,02	0,10	0,20	--	--
40 000 – 74 999	--	0,50	0,10	0,05	0,02	0,02	0,20	0,50	--	--
75 000 – 100 000	--	2,00	0,20	0,05	0,05	0,05	0,30	1,00	--	--
100 001 – 199 999	--	--	0,20	0,05	0,05	0,05	--	--	--	--
200 000 – 399 999	--	--	0,30	0,10	0,07	0,10	--	--	--	--
400 000 – 749 999	--	--	0,50	0,50	0,20	0,5	--	--	--	--
750 000 – 1 000 000	--	--	1,00	1,00	1,00	1,00	--	--	--	--

11. Specification is valid for four terminal pair measuring principle. If DUT uses a different measure method, an additional deviation can affect result of calibration in frequency range above 100 kHz.

Resistance calibration value uncertainty [%] with correction ON ¹²

Standard (Ω)	0.1	1	10	100	1k	10k	100k	1M	10M	100M
Frequency [Hz]	Calibration uncertainty [%]									
20 - 399	0,20	0,10	0,05	0,02	0,02	0,02	0,02	0,03	0,05	0,10
400 - 749	0,20	0,10	0,05	0,02	0,02	0,02	0,02	0,03	0,05	0,20
750 - 1 999	0,20	0,10	0,05	0,02	0,02	0,02	0,02	0,03	0,05	0,50
2 000 - 3 999	0,30	0,10	0,05	0,02	0,02	0,02	0,02	0,03	0,05	1,00
4 000 - 5 000	0,50	0,10	0,05	0,02	0,02	0,02	0,02	0,03	0,05	2,00
5 001 - 7 499	0,50	0,10	0,05	0,02	0,02	0,02	0,02	0,03	0,05	--
7 500 - 10 000	1,00	0,10	0,05	0,02	0,02	0,02	0,02	0,05	0,25	--
10 001 - 19 999	--	0,10	0,05	0,02	0,02	0,02	0,02	0,05	--	--
20 000 - 39 999	--	0,10	0,05	0,02	0,02	0,02	0,05	0,10	--	--
40 000 - 74 999	--	0,15	0,05	0,02	0,02	0,02	0,05	0,20	--	--
75 000 - 100 000	--	0,20	0,05	0,02	0,02	0,03	0,10	0,50	--	--
100 001 - 199 999	--	0,20	0,05	0,02	0,02	0,03	--	--	--	--
200 000 - 399 999	--	--	0,10	0,07	0,03	0,07	--	--	--	--
400 000 - 749 999	--	--	0,15	0,20	0,05	0,20	--	--	--	--
750 000 - 1 000 000	--	--	0,50	0,50	0,15	0,35	--	--	--	--

12. Specification is valid for four terminal pair measuring principle. If DUT uses a different measure method, an additional deviation can affect result of calibration in frequency range above 100 kHz.

Resistance types

Nominal value	Type of segment
0.1 Ω - 100 k Ω	Foil resistor
1 M Ω - 10 M Ω	Wraparound resistor
100 M Ω	T network 10 M Ω - 1.25 M Ω - 10 M Ω

9.6. 4TP Capacitance standards (coaxial output)

Stability and working parameters

Nominal value of parallel capacitance	1 year stability (typical)	Maximal deviation to nominal value at 1 kHz	Temperature coefficient T_k (maximal)	Dissipation factor at 1kHz	Max. Voltage / Current
10.000 pF	0.010 %	0.5 pF	0.005 %/°C	< 0.0020	30V
100.000 pF	0.010 %	5 %	0.005 %/°C	< 0.0010	30V
1.00000 nF	0.010 %	5 %	0.005 %/°C	< 0.0010	30V
10.0000 nF	0.010 %	5 %	0.005 %/°C	< 0.0010	30V
100.000 nF	0.010 %	5 %	0.005 %/°C	< 0.0010	20V
1.00000 μ F	0.010 %	5 %	0.025 %/°C	< 0.0010	10V
10.0000 μ F	0.015 %	5 %	0.025 %/°C	< 0.0050	100mA
100.00 μ F	0.015 %	5 %	0.025 %/°C	< 0.0200	200 mA

Typical capacitance frequency flatness with OPEN/SHORT/LOAD correction ^{*13 *14 *15}

Nominal value of parallel capacitance	Capacitance deviation				
	100 Hz to 1 kHz	1 kHz	10 kHz to 1 kHz	100 kHz to 1 kHz	1 MHz to 1 kHz
10.000 pF	+0.10 %	0.00 %	-0.10 %	-0.15 %	--
100.000 pF	+0.01 %	0.00 %	-0.01 %	-0.02 %	+0.20 %
1.00000 nF	0.00 %	0.00 %	0.00 %	0.00 %	+0.10 %
10.0000 nF	+0.02 %	0.00 %	-0.02 %	0.00 %	+0.10 %
100.000 nF	+0.02 %	0.00 %	-0.02 %	+0.02 %	+1.00 %
1.00000 μF	0.00 %	0.00 %	0.00 %	+0.10 %	--
10.0000 μF	+0.35 %	0.00 %	-0.10 %	--	--
100.00 μF	+0.18 %	0.00 %	1.00 %	--	--

13. Parameters are valid when OPEN/SHORT calibration is performed in DUT using OPEN/SHORT positions from the M550 calibrator before calibration. Parameters are valid when applied coaxial test cables delivered with the calibrator, length 50 cm

14. Parallel capacitance is specified. Relative frequency deviations are related to reference value at 1 kHz.

15. 4TP frequency flatness table show typical frequency dependency of partial standards. Depending on type of applied components the frequency deviation can be different in individual serial numbers. Use calibration values data in M550.

Typical capacitance frequency flatness Without OPEN/SHORT/LOAD correction ^{*16 *17 *18}

Nominal value of parallel capacitance	Capacitance deviation				
	100 Hz to 1 kHz	1 kHz	10 kHz to 1 kHz	100 kHz to 1 kHz	1 MHz to 1 kHz
10.000 pF	+0.10 %	0.00 %	-0.10 %	-0.10 %	--
100.000 pF	+0.01 %	0.00 %	-0.01 %	-0.02 %	+0.35 %
1.00000 nF	0.00 %	0.00 %	0.00 %	0.00 %	+0.30 %
10.0000 nF	+0.02 %	0.00 %	-0.02 %	+0.01 %	+0.30 %
100.000 nF	+0.03 %	0.00 %	-0.02 %	+0.03 %	+2.00 %
1.00000 μF	0.00 %	0.00 %	0.00 %	+0.20 %	--
10.0000 μF	0.45 %	0.00 %	-0.10 %	--	--
100.00 μF	+0.30 %	0.00 %	+1.00 %	--	--

16. Specification is valid without performing OPEN/SHORT corrections. Calibration values are valid in plane of M550 calibrator coaxial output terminals

17. Parallel capacitance is specified. Relative frequency deviations are related to reference value at 1 kHz.

18. 4TP frequency flatness table show typical frequency dependency of partial standards. Depending on type of applied components the frequency deviation can be different in individual serial numbers. Use calibration values data in M550.

Capacitance calibration value uncertainty [%] with correction OFF ^{*19}

Standard (F)	10p	100p	1n	10n	100n	1μ	10μ	100μ
Frequency [Hz]	Calibration uncertainty [%]							
20 - 74	1,00	0,30	0,10	0,10	0,10	0,10	0,10	0,10
75 - 199	1,00	0,30	0,05	0,05	0,10	0,05	0,05	0,10
200 - 399	1,00	0,20	0,05	0,05	0,10	0,05	0,05	0,10
400 - 749	1,00	0,20	0,05	0,05	0,05	0,05	0,05	0,10
750 - 1 999	1,00	0,10	0,05	0,05	0,05	0,05	0,05	0,10
2 000 - 3 999	1,00	0,10	0,05	0,05	0,05	0,05	0,10	0,20
4 000 - 7 499	1,00	0,10	0,05	0,05	0,05	0,05	0,15	0,50
7 500 - 10 000	1,00	0,10	0,05	0,05	0,05	0,05	0,30	1,00
10 001 - 19 999	1,00	0,10	0,05	0,05	0,05	0,05	--	--
20 000 - 39 999	1,00	0,10	0,05	0,05	0,10	0,15	--	--
40 000 - 74 999	1,00	0,10	0,05	0,05	0,10	0,25	--	--
75 000 - 100 000	1,00	0,10	0,10	0,05	0,30	0,50	--	--
100 001 - 199 999	1,00	0,10	0,10	0,05	0,30	--	--	--
200 000 - 399 999	1,00	0,15	0,15	0,10	0,50	--	--	--
400 000 - 749 999	1,00	0,35	0,20	0,15	1,00	--	--	--
750 000 - 1 000 000	2,00	0,70	0,35	0,20	2,00	--	--	--

19. Specification is valid for four terminal pair measuring principle. If DUT uses a different measure method, an additional deviation can affect result of calibration in frequency range above 100 kHz.

Capacitance calibration value uncertainty [%] with correction ON ^{*20}

Standard (F)	10p	100p	1n	10n	100n	1 μ	10 μ	100 μ
Frequency [Hz]	Calibration uncertainty [%]							
20 - 74	0,50	0,30	0,10	0,10	0,10	0,10	0,10	0,10
75 - 199	0,50	0,30	0,05	0,05	0,10	0,05	0,05	0,10
200 - 399	0,50	0,20	0,05	0,05	0,10	0,05	0,05	0,10
400 - 749	0,50	0,20	0,05	0,05	0,05	0,05	0,05	0,10
750 - 1 999	0,50	0,10	0,05	0,05	0,05	0,05	0,05	0,10
2 000 - 3 999	0,50	0,10	0,05	0,05	0,05	0,05	0,10	0,10
4 000 - 7 499	0,50	0,05	0,05	0,05	0,05	0,05	0,10	0,20
7 500 - 10 000	0,50	0,05	0,05	0,05	0,05	0,05	0,20	0,50
10 001 - 19 999	0,50	0,05	0,05	0,05	0,05	0,05	--	--
20 000 - 39 999	0,50	0,05	0,05	0,05	0,05	0,10	--	--
40 000 - 74 999	0,50	0,05	0,05	0,05	0,10	0,15	--	--
75 000 - 100 000	0,50	0,10	0,10	0,05	0,20	0,25	--	--
100 001 - 199 999	0,50	0,10	0,10	0,05	0,20	--	--	--
200 000 - 399 999	0,50	0,10	0,10	0,10	0,40	--	--	--
400 000 - 749 999	1,00	0,25	0,15	0,15	0,60	--	--	--
750 000 - 1 000 000	1,00	0,50	0,25	0,20	1,50	--	--	--

20. Specification is valid for four terminal pair measuring principle. If DUT uses a different measure method, an additional deviation can affect result of calibration in frequency range above 100 kHz.

Capacitance types

Nominal value	Type of segment / dielectric
10 pF - 1 uF	ceramic chip COG
10 uF - 100 uF	compensated foil capacitor / polypropilen+polyester

Table 9 4TP Capacitance

9.7. 4TP Inductance standards (coaxial output)

Stability and working parameters

Typical 1 year stability:	0.01%
Maximal temperature coefficient Tk:	0.005 % / °C
Maximal deviation to nom. val. at 1 kHz:	15%

Nominal value of serial inductance	Serial resistance R_s (typical)	Max. Voltage / Current
10.00000 μ H	66 Ω	50 mA
100.000 μ H	200 Ω	30 mA
1.00000 mH	660 Ω	5 V / 20 mA
10.0000 mH	660 Ω	5 V / 10 mA
100.000 mH	2 000 Ω	10 V
1.00000 H	20 000 Ω	10 V
10.0000 H	20 000 Ω	10 V

L frequency flatness with OPEN/SHORT/LOAD correction *21 *22 *23

Nominal value of serial inductance	Max. inductance deviation		
	100 Hz to 1 kHz	10 kHz to 1 kHz	100 kHz to 1 kHz
10.0000 μ H	--	0.01 %	0.10 %
100.000 μ H	0.01 %	0.01 %	0.10 %
1.00000 mH	0.01 %	0.01 %	0.05 %
10.0000 mH	0.01 %	0.01 %	0.05 %
100.000 mH	0.01 %	0.01 %	0.05 %
1.00000 H	0.01 %	0.01 %	--
10.0000 H	0.01 %	0.01 %	--

21. Parameters are valid when OPEN/SHORT calibration is performed in DUT using OPEN/SHORT positions from the M550 calibrator before calibration. Parameters are valid when applied coaxial test cables delivered with the calibrator, length 50 cm
22. Serial inductance is specified. All inductances are simulated using T-type RC networks. Frequency deviations are related to reference value at 1kHz
23. The table shows maximal frequency dependency of partial standards. See calibration values in M550 for exact value.

L frequency flatness without OPEN/SHORT/LOAD correction ^{*24 *25 *26}

Nominal value of serial inductance	Max. inductance deviation		
	100 Hz to 1 kHz	10 kHz to 1 kHz	100 kHz to 1 kHz
10.0000 µH	--	0.01 %	0.10 %
100.000 µH	--	0.01 %	0.10 %
1.00000 mH	0.01 %	0.01 %	0.10 %
10.0000 mH	0.01 %	0.01 %	0.10 %
100.000 mH	0.01 %	0.01 %	4.00 %
1.00000 H	0.01 %	0.01 %	--
10.0000 H	0.01 %	0.01 %	--

24. Specification is valid without performing OPEN/SHORT corrections. Calibration values are valid in plane of M550 calibrator coaxial output terminals
25. Serial inductance is specified. All inductances are simulated using T-type RC networks. Frequency deviations are related to reference value at 1kHz
26. The table shows maximal frequency dependency of partial standards. See calibration values in M550 for exact value.

Inductance calibration value uncertainty [%] with correction OFF ^{*27}

Standard (H)	10µ	100µ	1m	10m	100m	1	10
Frequency [Hz]	Calibration uncertainty [%]						
20 – 1 999	0,50	0,30	0,10	0,10	0,10	0,10	0,10
2 000 – 3 999	0,50	0,30	0,10	0,10	0,10	0,20	0,20
4 000 – 7 499	0,50	0,30	0,10	0,10	0,10	0,50	0,50
7 500 – 10 000	0,50	0,30	0,10	0,10	0,10	1,00	1,00
10 001 – 19 999	0,50	0,30	0,10	0,10	0,10	--	--
20 000 – 39 999	0,50	0,30	0,10	0,20	0,30	--	--
40 000 – 74 999	1,00	0,50	0,20	0,50	1,00	--	--
75 000 – 100 000	2,00	1,00	0,50	1,00	4,00	--	--

27. Specification is valid for four terminal pair measuring principle. If DUT uses a different measure method, an additional deviation can affect results of calibration in frequency range above 100 kHz.

Inductance calibration value uncertainty [%] with correction ON ^{*13}

Standard (H)	10 µ	100 µ	1m	10m	100m	1	10
Frequency [Hz]	Calibration uncertainty [%]						
20 – 7499	0,30	0,20	0,10	0,10	0,10	0,10	0,10
7 500 – 10 000	0,30	0,20	0,10	0,10	0,10	0,20	0,20
10 001 – 74 999	0,30	0,20	0,10	0,10	0,10	--	--
75 000 – 100 000	0,50	0,50	0,15	0,15	0,15	--	--

Inductance types

Nominal value	Type of segment
10 uH	T-network 55 Ω - 33 nF - 55 Ω
100 uH	T-network 100 Ω - 10 nF - 100 Ω
1 mH	T-network 316 Ω - 10 nF - 316 Ω
10 mH	T-network 316 Ω - 100 nF - 316 Ω
100 mH	T-network 1 kΩ - 100 nF - 1 kΩ
1 H	T-network 10 kΩ - 10 nF - 10 kΩ
10 H	T-network 10 kΩ - 100 nF - 10 kΩ

9.8. Resistance standards 4W and 2W (banana output)

Stability and working parameters

Nominal value of serial resistance	1 year stability (typical)	Temperature coefficient T_k (maximal)	Max. test Voltage / Current	Calibration uncertainty at 1 kHz			
				Nominal value 4W	4W - CORR OFF ^{*28}	4W - CORR ON ^{*28}	2W ^{*29}
0.10000 Ω	0.001 %	0.0050 %/°C	200 mA	2.0 %	1.00 %	0.50 %	--
1.00000 Ω	0.001 %	0.0002 %/°C	200 mA	1.5 %	0.50 %	0.10 %	5.0 %
10.0000 Ω	0.001 %	0.0002 %/°C	150 mA	1.0 %	0.10 %	0.05 %	0.5 %
100.000 Ω	0.001 %	0.0002 %/°C	50 mA	1.0 %	0.05 %	0.05 %	0.1 %
1.00000 kΩ	0.001 %	0.0002 %/°C	10 V	1.0 %	0.02 %	0.02 %	0.1 %
10.0000 kΩ	0.001 %	0.0002 %/°C	30 V	1.0 %	0.02 %	0.02 %	0.1 %
100.000 kΩ	0.001 %	0.0002 %/°C	50 V	1.0 %	0.10 %	0.05 %	0.1 %
1.00000 MΩ	0.003 %	0.0002 %/°C	50 V	1.0 %	0.2 %	0.2 %	0.2 %
10.0000 MΩ	0.010 %	0.0010 %/°C	50 V	2.0 % ^{*30}	0.2 % ^{*30}	0.2 % ^{*30}	0.5 %
100.000 MΩ	0.010 %	0.0025 %/°C	50 V	10.0 % ^{*30}	1.0 % ^{*30}	1.0 % ^{*30}	--

28. Calibration uncertainty is displayed in for frequency range from 900 Hz to 1100 Hz.

29. Two wire connection. Only primary parameter is displayed at frequency 1 kHz.

30. Specified at frequency 100 Hz.

4W Frequency flatness – 4W connection ^{*31 *32 *33}

Nominal value of serial resistance	Max. deviation			
	100 Hz to DC	1 kHz to DC	10 kHz to DC	100 kHz to DC
0.10000 Ω	0.10 %	0.50 %	--	--
1.00000 Ω	0.02 %	0.10 %	0.10 %	--
10.0000 Ω	0.02 %	0.02 %	0.05 %	0.20 %
100.000 Ω	0.02 %	0.02 %	0.05 %	0.10 %
1.00000 kΩ	0.02 %	0.02 %	0.05 %	0.50 %
10.0000 kΩ	0.02 %	0.02 %	0.20 %	--
100.000 kΩ	0.02 %	0.20 %	2.00 %	--
1.00000 MΩ	0.20 %	1.50 %	--	--
10.0000 MΩ	0.50 %	10 %	--	--
100.000 MΩ	30 %	--	---	--

31. Serial resistance is specified. Frequency deviations are related to DC reference value.

32. Values are valid both for CORR ON and CORR OFF mode.

33. The table shows maximal frequency dependency of partial standards. See calibration values in M550 for exact value.

4W / 2W Resistance types

Nominal value	Type of segment
0.1 Ω - 100 kΩ	Foil resistor
1 MΩ	Wraparound resistor
10 MΩ - 100 MΩ	Thin-layer metal resistor

9.9. Capacitance standards 4W and 2W (banana output)

Stability and working parameters

Maximal deviation:

Nominal value at 1 kHz (4W – CORR OFF): 10%

Nominal value of parallel capacitance	1 year stability (typical)	Temperature coefficient T _k (maximal)	Max. Voltage / Current	Calibration uncertainty at 1 kHz			4W – CORR ON Dissipation factor at 1kHz
				4W- CORR OFF ^{*34}	4W- CORR ON ^{*34}	2W ^{*35}	
100.00 pF	0.015 %	0.050 %/°C	30V	5.00 %	1.0 %	5.0 %	< 0,005
1.00000 nF	0.010 %	0.050 %/°C	30V	0.50 %	0.10 %	1.0 %	< 0,002
10.0000 nF	0.010 %	0.050 %/°C	30V	0.10 %	0.05 %	0.2 %	< 0,001
100.000 nF	0.010 %	0.050 %/°C	20V	0.10 %	0.05 %	0.2 %	< 0,001
1.00000 μF	0.010 %	0.050 %/°C	10V	0.10 %	0.05 %	0.2 %	< 0,005
10.0000 μF	0.015 %	0.010 %/°C	100mA	0.20 %	0.10 %	0.5 %	< 0,015
100.000 μF	0.150 %	0.010 %/°C	200 mA	0.30 %	0.20 %	1.0 %	< 0,030

34. Calibration uncertainty is displayed in for frequency range from 900 Hz to 1100 Hz.

35. Two wire connection. Only primary parameter is displayed at frequency 1 kHz.

Frequency flatness – 4W connection ^{*36 *37 *38}

Nominal value of parallel capacitance	Capacitance C _p max. deviation		
	100 Hz to 1 kHz	10 kHz to 1 kHz	100 kHz to 1 kHz
100.00 pF	0.20 %	0.50 %	--
1.00000 nF	0.50 %	0.30 %	1.00 %
10.0000 nF	0.05 %	0.05 %	0.20 %
100.000 nF	0.03 %	0.10 %	2.00 %
1.00000 µF	0.50 %	1.00 %	7.00 %
10.0000 µF	0.50 %	1.00 %	--
100.000 µF	1.00 %	--	--

36. Parallel capacitance is specified. Relative frequency deviations are related to reference value at 1 kHz.

37. Values are valid both for CORR ON and CORR OFF mode.

38. The table shows maximal frequency dependency of partial standards. See calibration values in M550 for exact value.

4W / 2W Capacitance types

Nominal value	Type of segment/dielectric
100 pF - 100 nF	ceramic chip COG
1 µF - 100 µF	compensated foil capacitor/ polypropylene+polyester

9.10. OPEN/SHORT parameters

OPEN	4TP Residual capacitance	< 0.5 pF at 10 kHz
	4TP Residual conductance	< 10 nS at 10 kHz
	4W Residual capacitance	< 40 pF at 1 kHz
	4W Residual conductance	< 10 nS at 1 kHz
SHORT	4TP Residual resistance	< 1 mΩ at 10 kHz
	4TP Residual inductance	< 10 nH at 10 kHz
	4W Residual resistance	< 1 mΩ at 1 kHz
	4W Residual inductance	< 200 nH at 1 kHz

Comment:

1. Calibration values define impedance parameters of internal partial standards. They do not cover potential additional deviations caused by test cables between DUT and M550 calibrator.
2. Calibration uncertainty is specified for temperature range $23\text{ °C} \pm 2\text{ °C}$ and for $\text{RH} < 80\%$ working condition. In temperature range out of $23\text{ °C} \pm 2\text{ °C}$ limits, and within range of operating temperatures add additional uncertainty given by specified temperature coefficient and operating temperature difference:

$$\text{Unc} = \text{Unc (reference conditions) (\%)} + T_k (\%/^{\circ}\text{C}) * dT (\text{°C})$$

Where Unc is calibration uncertainty

Tk is temperature coefficient of the partial standard

dT is deviation between operating temperature and limit of reference condition band

3. Uncertainty of calibration values is guaranteed for sin wave test signal of DUTs. When calibrated LCR meters based on charging/discharging principle, undefined deviation against calibration values can occur.
4. Uncertainty of calibration values is guaranteed for main parameter. Auxiliary parameter calibration value is typical.
5. Calibration values between spot frequencies are calculated using three point quadrature approximation. Additional uncertainty due to the approximation formula is lower than 0.005%.

CE Certificate of conformity

According to EN ISO/IEC 17050-1:2010 standard as well as 2014/30/EU and 2014/35/EU directives of European Parliament and European Council, MEATEST, spol. s r. o., manufacturer of M550 Impedance Calibrator, based in Železná 3, 619 00 Brno, Czech Republic, declares that its product conforms to following specifications:

Safety requirements

- EN 61010-1 ed. 2:2010 + A1:2016 + COR1:2019-03

Electromagnetic compatibility

- EN 61000 part 3-2 ed. 5:2019
- EN 61000 part 3-3 ed. 3:2014
- EN 61000 part 4-2 ed. 2:2009
- EN 61000 part 4-3 ed. 3:2006 + A1:2008 + A2:2011 + Z1:2010
- EN 61000 part 4-4 ed. 3:2013
- EN 61000 part 4-5 ed. 3:2015 + A1:2018
- EN 61000 part 4-6 ed. 4:2014
- EN 61000 part 4-11 ed. 2:2005
- EN 61326-1 ed. 2:2013
- EN 55011 ed. 4:2015 + A1:2016 + A11:2020

Brno

September 25th, 2020

Place

Date



Signature