

Reduced size, ultra-stable, high precision (ppm class) fluxgate technology DT Series current transducer for isolated DC and AC current measurement up to 200Arms

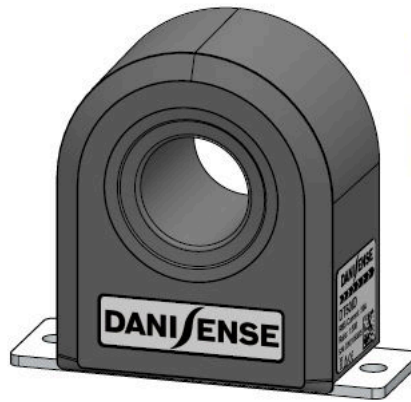
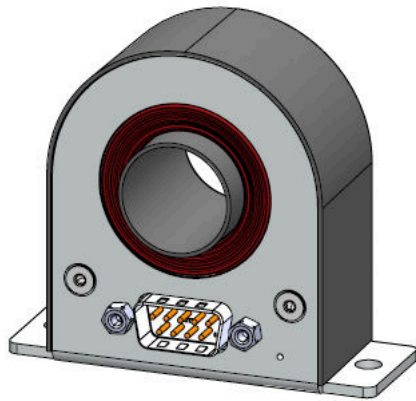

Features

- ◇ Fluxgate, closed loop compensated technology with fixed excitation frequency and second harmonic zero flux detection for best in class accuracy and stability
- ◇ 2 MHz high frequency bandwidth
- ◇ Excellent linearity, better than 1 ppm
- ◇ Industry standard DSUB 9 pin connection
- ◇ Green diode for normal operation indication
- ◇ Large aperture Ø20.7mm for cables and bus bars

Applications

- ◇ Optimized for space constraint applications
- ◇ MPS for particles accelerators
- ◇ Gradient amplifiers for MRI devices
- ◇ Stable power supplies
- ◇ Precision drives
- ◇ Batteries testing and evaluation systems
- ◇ Power measurement and power analysis
- ◇ Variable speed drives

Specification highlights	Symbol	Unit	Min	Typ	Max
Nominal primary AC current	$I_{PN AC}$	Arms			200
Nominal primary DC current	$I_{PN DC}$	A	-200		200
Measuring range	\hat{I}_{PM}	A	-285		285
Primary / secondary ratio	$n1 : n2$		1:1000		1:1000
Linearity error	ϵ_L	ppm	-1	0.4	1
Offset current (including earth field)	I_{OE}	ppm	-25		25
DC-10Hz Overall accuracy @25°C (= $\epsilon_L + I_{OE}$)	acc ϵ	ppm	-26		26
Bandwidth	$f(\pm 3dB)$	kHz		2000	
AC typical gain error 10Hz to 5kHz	ϵ_G	%		± 0.01	
Operating temperature range	T_a	°C	-40		85
Power supply voltages	U_c	V	± 14.25		± 15.75

All ppm (or %) values refer to nominal current

Electrical specifications at Ta=23°C, supply voltage = ± 15V unless otherwise stated

Parameter	Symbol	Unit	Min	Typ.	Max	Comment	
Nominal primary AC current	$I_{PN AC}$	Arms			200	Refer to fig. 1 & 2 for derating	
Nominal primary DC current	$I_{PN DC}$	A	-200		200	Refer to fig. 1 for derating	
Measuring range	I_{PM}	A	-285		285	Refer to fig. 1 & 2 for derating	
Overload capacity	\hat{I}_{OL}	A	-1000		1000	Non-measured, 100ms	
Nominal secondary current	I_{SN}	mA	-200		200	At nominal primary DC current	
Primary / secondary ratio			1:1000		1:1000		
Measuring resistance	R_M	Ω	0		5	Refer to fig. 1 for details	
Linearity error	ϵ_L	ppm μA	-1 -0.2	0.4 0.08	1 0.2	ppm refers to nominal current μA refers to secondary current	
Offset current	I_{OE}	ppm μA	-25 -5		25 5	ppm refers to nominal current μA refers to secondary current	
DC-10Hz Overall accuracy @25°C (= ϵ_L + IOE)	acc ϵ	ppm	-26		26	ppm refers to nominal DC current	
Offset temperature coefficient	TC_{IOE}	ppm/K $\mu A/K$	-0.2 -0.04	0.1 0.02	0.2 0.04	ppm refers to nominal current μA refers to secondary current	
Bandwidth	$f(\pm 3dB)$	kHz		2000		Small signal, graphs figure 3	
Amplitude error	ϵ_G	%		10Hz -5kHz	0.01%	% refers to nominal current	
5kHz -100kHz				1%			
100kHz - 1000kHz				10%			
1000kHz - 2000kHz				30%			
Phase shift	θ	°		10Hz -5kHz	0.01°		
5kHz -100kHz				0.5°			
100kHz - 1000kHz				5°			
1000kHz - 2000kHz				30°			
Response time to a step current I_{PN}	$tr @ 90\%$	μs		1		$di/dt = 100A/\mu s$	
RMS noise	noise	ppm RMS		0.1Hz - 10Hz	0.01	0.03	ppm RMS refers to nominal current
0.1Hz - 100Hz				0.2	0.5		
0.1Hz - 1kHz				0.3	0.7		
0.1Hz - 10kHz				0.5	0.9		
0.1Hz - 100kHz				3.3	6		
Peak-to-peak noise	noise	ppm p-p		0.1Hz - 10Hz	0.2	0.3	ppm peak-to-peak refers to nominal current
0.1Hz - 100Hz				0.8	1		
0.1Hz - 1kHz				1.6	2		
0.1Hz - 10kHz				2.5	4		
0.1Hz - 100kHz				25	40		
Fluxgate excitation frequency	f_{Exc}	kHz		31.25			
Induced rms voltage on primary conductor		μV rms			5		
Power supply voltages	U_c	V	± 14.25		± 15.75		
Positive current consumption	I_{ps}	mA		40		Add I_s (if I_s is positive)	
Negative current consumption	I_{ns}	mA		35		Add I_s (if I_s is negative)	
Operating temperature range	T_a	°C	-40		85		
Stability							
Offset stability over time		ppm/month $\mu A/month$	-0.1 -0.02		0.1 0.02	ppm refers to nominal current μA refers to secondary current	
Impact of external magnetic field		ppm/mT $\mu A/mT$	-4 -0.8	1 0.2	4 0.8	ppm refers to nominal current μA refers to secondary current	
Offset change with power supply voltages changes		$\mu A/V$		0.01		μA refers to secondary current	

Measurement resistor RM and ambient temperature derating (Fig. 1)

Maximum measurement resistor vs. ambient temperatures

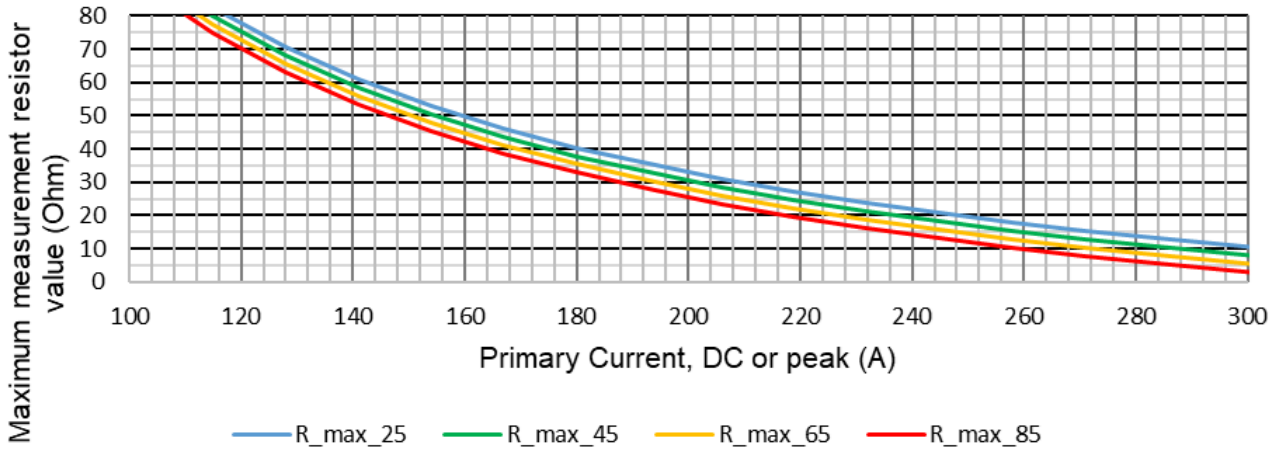

Frequency and ambient temperature derating (Fig. 2)

Maximum primary current A_{rms}

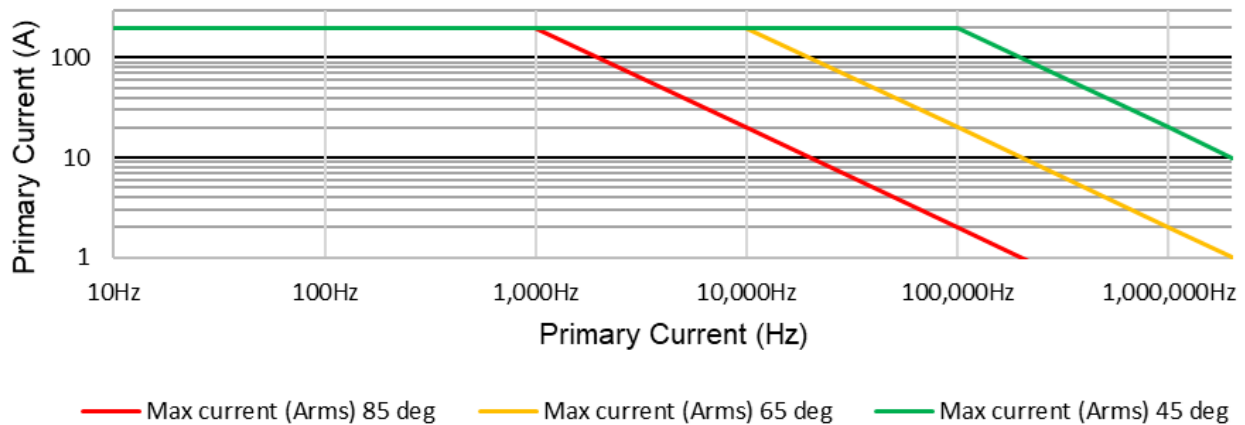

Frequency characteristics (Fig. 3)

Typical Amplitude / Phase response

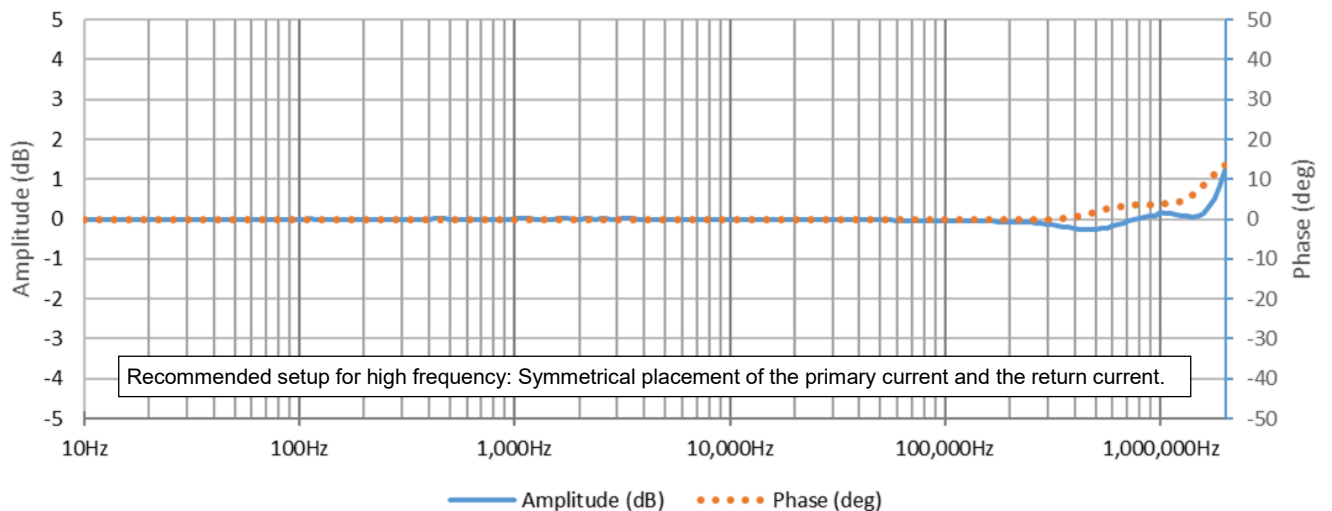

Isolation specifications

Parameter	Unit	Value
Clearance	mm	11.5
Creepage distance	mm	11.5
Rms voltage for AC isolation test, 50/60 Hz, 1 min - Between primary and (secondary and shield) - Between secondary and shield	kV	5.7 0.2
Impulse withstand voltage (1.2/50µs)	kV	10.4
Rated rms isolation voltage reinforced isolation, overvoltage category III, Pollution degree 2 according to - IEC 61010-1 - EN50780	V	300 600

Absolute maximum ratings

Parameter	Unit	Max	Comment
Primary	A	1000	Maximum 100ms
Power supply	V	±16.5	

Environmental and mechanical characteristics

Parameter	Unit	Min	Typ	Max	Comment
Altitude	m			2000	
Usage					Designed for indoor use
Transient voltages					Up to overvoltage category III
Polution Degree				2	
Ambient operating temperature range	°C	-40		85	
Storage temperature range	°C	-40		85	
Relative humidity	%	20		80	Non-condensing
Mass	kg		0.15		
Connections	Power supplies: D-SUB 9 pins male				
Standards	IEC61010-2-30 IEC61326-1 EMC IEC61010-1:2010 3rd Edition				

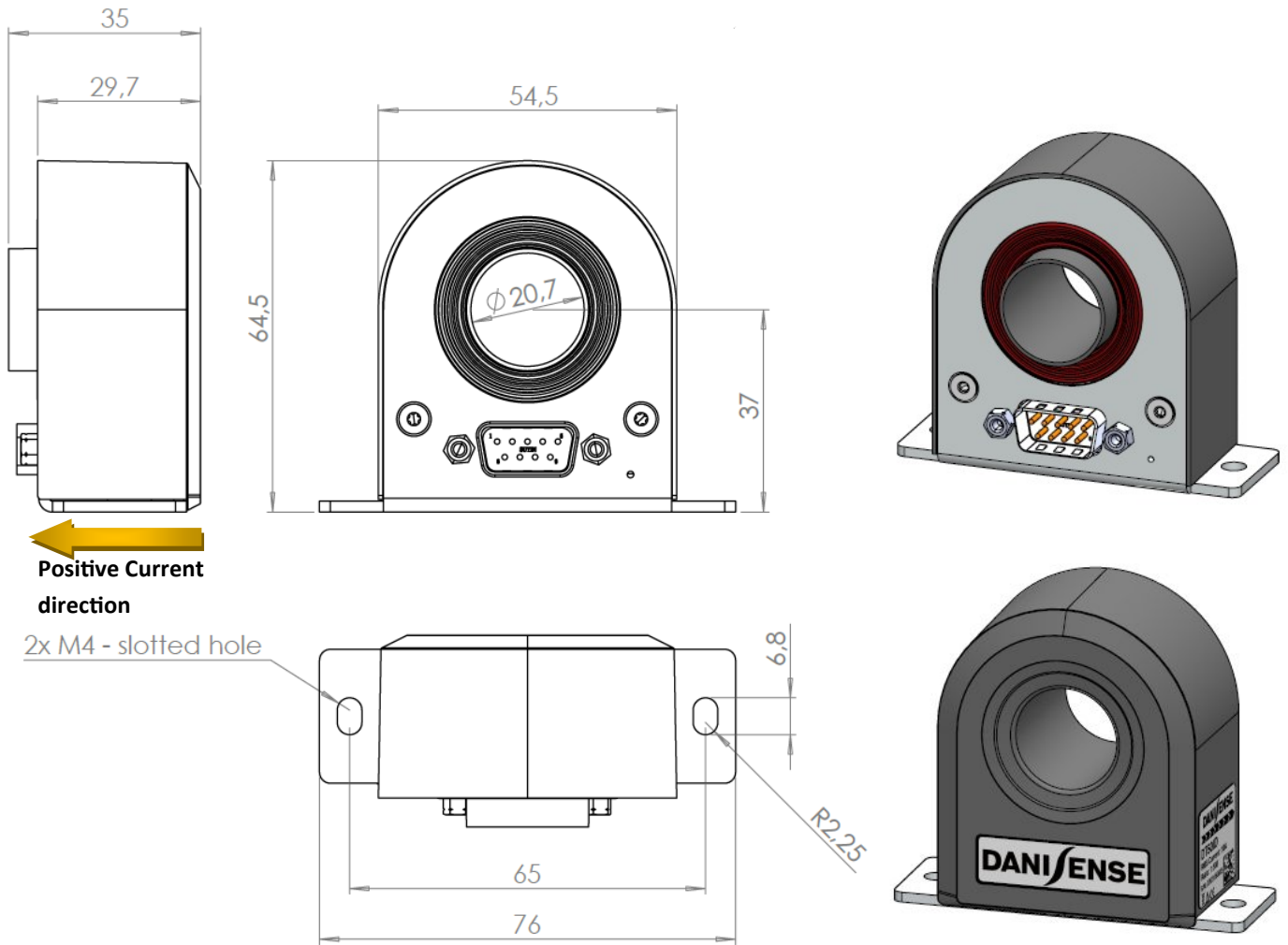

(general tolerance 0.3mm unless otherwise stated)

DSUB pin layout

Standard DSUB-9 current output



When sensor is operating in normal condition the status pins are shorted.

- Status pin properties.
- Forward direction pin 8 to pin 3
 - Maximum forward current 10mA
 - Maximum forward voltage 60V
 - Maximum reverse voltage 5V

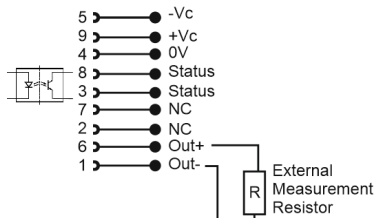

Positive current direction

Is identified by an arrow on the transducer body

Mounting instructions

Base plate mounting:

- ◇ 2 x M4 - slotted holes
- ◇ Suggested fastening torque: 5.5 Nm