

RIGOL

User Guide



PHA High-Voltage Differential Probe

Aug. 2020
RIGOL TECHNOLOGIES CO., LTD

Guaranty and Declaration

Copyright

© 2020 **RIGOL** TECHNOLOGIES CO., LTD. All Rights Reserved.

Trademark Information

RIGOL® is the trademark of **RIGOL** TECHNOLOGIES CO., LTD.

Publication Number

UGE33100-1110

Notices

- **RIGOL** products are covered by P.R.C. and foreign patents, issued and pending.
- **RIGOL** reserves the right to modify or change parts of or all the specifications and pricing policies at the company's sole decision.
- Information in this publication replaces all previously released materials.
- Information in this publication is subject to change without notice.
- **RIGOL** shall not be liable for either incidental or consequential losses in connection with the furnishing, use, or performance of this manual, as well as any information contained.
- Any part of this document is forbidden to be copied, photocopied, or rearranged without prior written approval of **RIGOL**.

Product Certification

RIGOL guarantees that this product conforms to the national and industrial standards in China as well as the ISO9001:2015 standard and the ISO14001:2015 standard. Other international standard conformance certifications are in progress.

Contact Us

If you have any problem or requirement when using our products or this manual, please contact **RIGOL**.

E-mail: service@rigol.com

Website: www.rigol.com









General Safety Summary

CAUTION

This device involves the high-voltage measurement. To use the device safely and ensure your personal safety, please carefully read and observe the instructions specified in this manual before using the device.

Safety Terms and Symbols

Before using the device, read the following safety notices carefully.

	<p>The  symbol printed on the device indicates that the user should refer to a corresponding topic in the manual (marked with the  symbol) before using the relevant function.</p> <p>In the manual, the  symbol indicates particularly important information that the user should read before using the device.</p>
	<p>The  symbol printed on the device indicates high voltage warning.</p>
	<p>The  symbol printed on the device indicates test ground.</p>

Safety Precautions

 **CAUTION**

- Beware of high voltages to avoid electric shock. Understand the maximum input voltage for the probe.
- Do not operate in wet conditions or in an explosive atmosphere.
- Before use, please check whether the exterior of the probe is damaged. If damaged, stop using it.
- Turn off the circuit under test before connecting it to the probe.
- When connecting the BNC output cable of the probe to the oscilloscope or other devices, ensure that the BNC terminal is safely grounded.
- After measurement, turn off the circuit first and then remove the probe.

Contents

Guaranty and Declaration	I
General Safety Summary	II
Safety Terms and Symbols	II
Safety Precautions	II
General Inspection	1
PHA High-Voltage Differential Probe	2
Probe Components	4
Probe Component Description.....	5
To Use the Probe	7
Preparation for Measurement.....	7
Measurement Steps	7
Precautions During Measurement.....	9
Failures and Troubleshooting	11
Specifications	12
Technical Specifications	12
Mechanical Characteristics.....	13
Working Environment.....	13
Warranty	14
Appendix	15
Appendix 1 Max. Differential Mode Voltage vs Freq.	15
Appendix 2 Package List.....	15

General Inspection

1. Inspect the packaging

RIGOL has carried out strict inspections on each product before leaving the factory. When you receive the product, please check whether the packaging is intact. If the packaging has been damaged, do not dispose the damaged packaging or cushioning materials until the shipment has been checked for completeness and the probe has passed both electrical and mechanical tests.

The consigner or carrier shall be liable for the damage to the instrument resulting from shipment. **RIGOL** would not be responsible for free maintenance/rework or replacement of the instrument.

2. Check the probe

In case of any mechanical damage, missing parts, or failure in passing the electrical and mechanical tests, contact your **RIGOL** sales representative.

3. Check the accessories

Please check the accessories according to **Appendix 2 Package List** in this manual. If the accessories are damaged or incomplete, please contact your **RIGOL** sales representative.

PHA High-Voltage Differential Probe

The PHA series high-voltage differential probe (hereinafter referred to as PHA series probe) connects to the voltage under test through the high-voltage differential input cable to convert the input high voltage into the low voltage, and then display the waveforms on the waveform measuring instrument by connecting its output interface to the waveform measuring instrument.

Main Features

- High bandwidth to meet the requirements of most high-frequency test system
PHA0150: 70 MHz;
PHA1150: 100 MHz
- Diversified ranges and two attenuations to meet the requirements for most common-mode test circuit
50X: 150 V (DC + peak AC);
500X: 1500 V (DC + peak AC);
- 5 MHz bandwidth limit^[1]
For the low-frequency signal measurement, this function can reduce the noise and interference of high-frequency signals to meet the measurement requirement for the switching frequency of most switching transistors (FETs) in the switching power supply.
- High-voltage differential input mode
- Higher input impedance and lower input capacitive on the input terminal ensure accurate and fast measurement
- Sound common-mode noise rejection
- Standard BNC output terminal, compatible with the waveform measuring instruments of most manufacturers.
- Audible alarm beeper and visible indicator blinking for sounding the alarm; the alarm can be disabled manually

RIGOL

- Auto memory function, capable of automatically saving the working status that was set before it is shutdown

Note^[1]:

When the bandwidth is limited to 5 MHz, the internal output circuit of the PHA series probe is connected to a 5 MHz low-pass network. The low-pass network can reduce the high-frequency components, the noise, and the harmonics, which is conducive to the testing and analysis of the low-frequency signals.

Measurement Scenarios

The PHA series probe is mainly used in scenarios where high-voltage floating measurement is required, such as

- Floating voltage measurement
- Switching power supply design
- inverter/UPS power measurement
- Inverter measurement
- Electronic ballast design
- CRT display design
- Low-voltage apparatus test
- Strong current or high voltage isolation measurement
- Power conversion and other related designs
- welding/plating power measurement
- Frequency conversion home appliance measurement: induction heating; induction cooker
- Motor drive design
- Electrical engineering experiment
- Power electronics and power drives experiment

Probe Components

The PHA series probe consists of PHA0150 and PHA1150. This manual takes PHA1150 as an example to introduce the components of the PHA series probe.

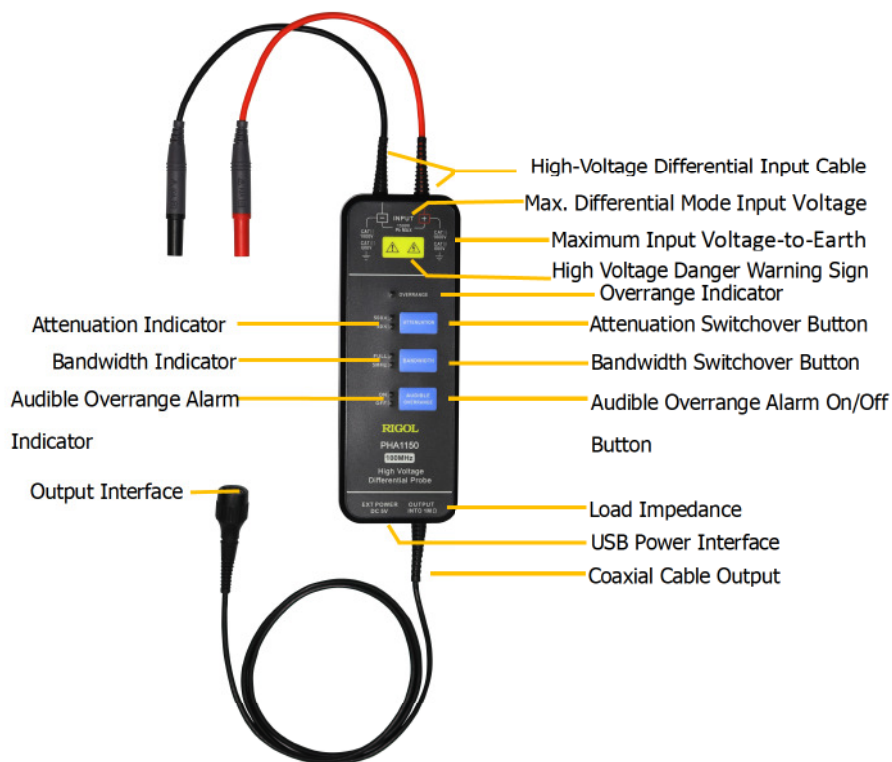

Figure 1 PHA1150 High-Voltage Differential Probe

By default, 500X is selected for OVERRANGE; FULL is selected for BANDWIDTH; and ON is selected for AUDIBLE OVERRANGE.

Probe Component Description

- **High-Voltage Differential Input Cable**

Used to measure the input voltage signal after connecting it to the insulated plunger hook clip. It can be extended with the extender leads (approx. 1 m). When using the extender leads, the frequency of the signal under test should be below 5 MHz.
- **Max. Differential Mode Input Voltage**

1500 V (DC + peak AC)
- **Overrange Indicator**

When the voltage under test exceeds the probe range, the overrange indicator lights on.
- **Attenuation Switchover Button**

Press this button to switch over between the voltage range (attenuation) settings of the probe. For the PHA series probe, two attenuation ratios are available: 500X and 50X.

 - ◇ 50X indicates that the max. measurement voltage is 150 V.
 - ◇ 500X indicates that the max. measurement voltage is 1500 V.
- **Bandwidth Switchover Button**

Press this button to switch over between the bandwidth. The PHA series probe supports two bandwidths.

 - ◇ FULL: indicates the full specified bandwidth of the probe. For PHA0150, its full bandwidth is 70 MHz; for PHA1150, its full bandwidth is 100 MHz.
 - ◇ 5 MHz: When measuring the low-frequency signal, to reduce the interference of the high-frequency signal, you can select the 5 MHz bandwidth.

- **Audible Overrange Alarm On/Off Button**

- ◇ ON: Turns on the alarm beeper.
- ◇ OFF: Turns off the alarm beeper.

When ON, an audible alarm will be sounded once the voltage under test exceeds the probe range.

- **Load Impedance**

The output impedance of the probe is 50 Ω . When the input impedance of the load (e.g. oscilloscope) is 1 M Ω , the measured signal amplitude is input amplitude. When the input impedance of the load is set to 50 Ω , the high-frequency amplitude-frequency characteristics will be flatter, and the measured signal amplitude is half of the input amplitude.

- **USB Power Interface**

A standard USB Type-C interface. It provides power with a standard USB adapter. You can connect it with the oscilloscope to provide power for the probe; or use the mobile power supply to charge for the probe. The power specification should be DC 5 V, 1 A.

- **Output Interface**

indicates a standard BNC output terminal, which is compatible with the waveform measuring instruments of most manufacturers.

To Use the Probe

Before using the current probe, make sure to refer to **Safety Precautions**.

Preparation for Measurement

1. Evaluate the amplitude of the voltage under test and check whether it is within the voltage range of the probe. If it is beyond the max. range of the probe, please replace a proper probe. Otherwise, the measurement would be incorrect or the probe may be damaged. Even worse, this may lead to safety accidents.
2. Prepare one power adapter (DC 5 V, 1 A).
3. Connect the probe to power source and have a 20-minute warm-up at least. Meanwhile, prepare one measuring instrument (e.g. an oscilloscope).
4. Please ensure that the device under test is powered off or the output is disabled.

Measurement Steps

Check and ensure that the measurement system is safe. Make sure that the above preparation for measurement is ready.

1. Connect the output cable of the probe to the input terminal of the measuring instrument.
2. Use the USB Type-C cable to connect its one end to the specified power adapter and the other end to the power interface of the probe. Insert the power adapter into the socket to provide power to the probe. If the indicators on the panel light on normally, it indicates that the probe has been launched normally.
3. Select a proper range for the probe based on the measuring voltage.
4. Select the proper attenuation ratio of the measuring instrument based on

the probe range. Then adjust the range of the instrument based on the voltage under test.

5. Select a proper probe clip according to the object under test. Connect one end of the clip to the input cable of the probe and connect the other end to the object under test.
6. Turn on the device under test to start testing.
During testing, keep the probe body far away from the high-voltage pulse circuit to reduce interference to the probe.

⚠ CAUTION

When the voltage under test exceeds the probe range, the overrange indicator lights on. If ON is selected for AUDIBLE OVERRANGE, it will sound an alarm. At this time, please turn off the device under test immediately.

After the test is completed, disconnect power from the circuit under test first, and then turn off the power of the probe. Disconnect two input terminals of the probe from the test point, and disconnect the output BNC connector from the measuring instrument.

When the extender leads are used, the connection steps are as follows:

1. Connect one end of the double-ended BNC coaxial cable to the BNC terminal of the high-voltage differential probe, and connect the other end to the input terminal of the oscilloscope.
2. Connect the output cable and input cable to the probe.

Precautions During Measurement

⚠ CAUTION

1. Before measurement, try to twist the high-voltage differential input cables as much as possible, which can better reduce the interference of the lead inductance and external noise to improve the anti-interference ability of the probe. The twisting method is shown in the figure below:

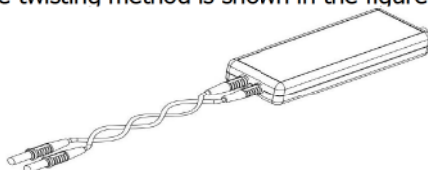

Figure 2 Twisting the High-Voltage Differential Input Cable

2. Try not to extend the input cable, as this will bring more noises. If you have to extend the cable, extend the cable with the same length. Besides, the input frequency should not be greater than 5 MHz. Otherwise, errors will occur for the output, as shown in the figure below.

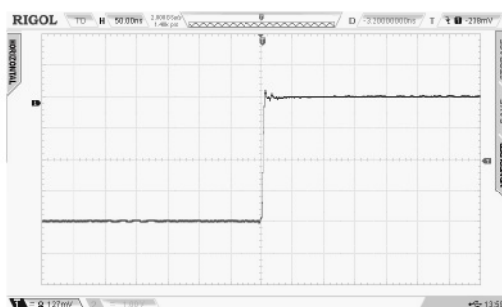

Figure 3 Waveforms Generated without Extending the Input Cable

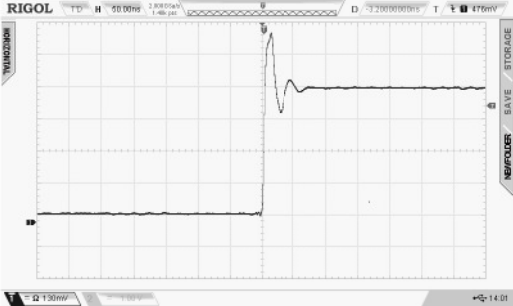

Figure 4 Waveforms Generated with the Input Cable Being Extended

Failures and Troubleshooting

	Failures Description	Troubleshooting
1.	The indicators on the panel blink or do not light.	<ol style="list-style-type: none">1. Check whether the power adapter plug and the power socket are properly connected.2. Check whether the power adapter output and the probe power interface are properly connected.3. Check whether the power adapter is working properly.
2.	The measured waveforms cannot be stably displayed or obvious errors occur.	<ol style="list-style-type: none">1. Check whether the probe input and the probe clip are properly connected; whether the probe clip is properly connected to the test point.2. Check whether the probe output is properly connected with the oscilloscope.3. Replace the probe or the measuring instrument to locate the problem.

Specifications

Technical Specifications

Characteristics		PHA0150	PHA1150
Bandwidth (-3 dB)		70 MHz	100 MHz
Rise Time		≤5 ns	≤3.5 ns
Accuracy		±2%	
Range (Attenuation)		50X/500X	
Maximum Measurable Differential Voltage (DC + peak AC)		50X: ±150 V 500X: ±1500 V	
Common Mode Voltage (DC + peak AC)		±1500 V	
Maximum Input Voltage-to-Earth (Vrms)		600 V CAT III 1000 V CAT II	
Input Impedance	Between each input and ground	5MΩ±1%	
	Between differential inputs	10MΩ±1%	
Input Capacitance	Between each input and ground	<4pF	
	Between differential inputs	<2pF	
CMRR	DC	>80 dB	
	100 kHz	>60 dB	
	1 MHz	>50 dB	
	3.2 MHz	>30 dB	
	50 MHz	>26 dB	
Input Referred Noise (Vrms)		50X: <50 mV 500X: <300 mV	
Overrange Voltage Threshold		50X: 153V±3V	

RIGOL

Indicator	500X: 1530V±30V
Delay	21 ns 16 ns
Bandwidth Limit (5 MHz)	≥-3 dB@5 MHz
Ovrange Indicator (Red)	Yes
Audible Ovrange Alarm	Yes (ON/Off is available)
Auto Save	Yes
Output Impedance	50 Ω
Safety Standards	EN61010-1:2010
EMC Standards	EN61326-1:2013; EN61000-3-3:2013 EN61000-3-2:2006+A1:2009+A2:2009

Mechanical Characteristics

Probe Dimensions	176 mm x 65 mm x 25 mm
Probe Body Weight	216 g
Insulated Plunger Hook Clip	152 mm x 50 mm x 13 mm
Alligator Clip	106 mm x 43 mm x 16 mm
High-Voltage Differential Input Cable Length	28 cm
Probe Output Cable Length	1 m

Working Environment

Environment Characteristics	Description
Operating Temperature	0°C to 50°C
Storage Temperature	-30°C to +70°C
Operating Humidity	≤85%RH
Storage Humidity	≤90%RH
Operating Altitude	3,000 m
Storage Altitude	12,000 m

Warranty

RIGOL TECHNOLOGIES CO., LTD. (hereinafter referred to as **RIGOL**) warrants that the product will be free from defects in materials and workmanship within the warranty period. If a product proves defective within the warranty period, **RIGOL** guarantees free replacement or repair for the defective product.

To get repair service, please contact with your nearest **RIGOL** sales or service office.

There is no other warranty, expressed or implied, except such as is expressly set forth herein or other applicable warranty card. There is no implied warranty of merchantability or fitness for a particular purpose. Under no circumstances shall **RIGOL** be liable for any consequential, indirect, ensuing, or special damages for any breach of warranty in any case.

Appendix

Appendix 1 Max. Differential Mode Voltage vs Freq.

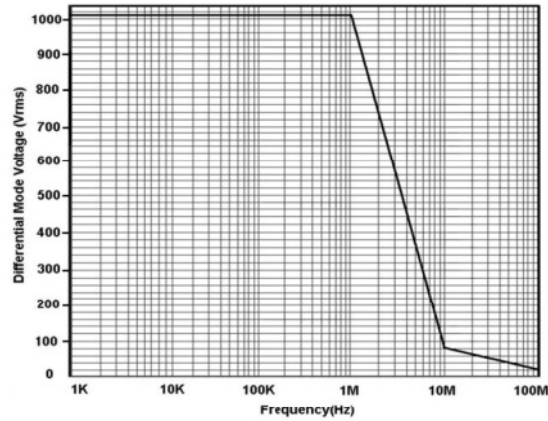

Figure 5 PHA0150/PHA1150 Max. Differential Mode Voltage vs Freq.

Appendix 2 Package List

This section lists the standard accessories of the PHA series probe.

Table 1 Standard Accessories of the PHA Series Probe

Name	Specification	Qty.
Probe Body	PHA0150/PHA1150	1
Alligator Clip	CAT II 1000 V CAT III 600 V	1 Pair (red/black)
Insulated Plunger Hook Clip	-	1 Pair (red/black)
USB Type-C Cable	1 m	1
User Guide	-	1
Warranty Card	-	1

Accessories



Alligator Clip



Insulated Plunger Hook Clip



USB Type-C Cable