

LCR Meter

6630

Component Tester

Features

- Signal source frequency range: DC, 10Hz to 1/3/5/10/20/30/50MHz
- Basic accuracy up to $\pm 0.05\%$
- ALC function
- Output impedance $25\ \Omega / 100\ \Omega$, switchable
- Support meter mode and list mode, can used with various fixtures, such as: liquid dielectric material test fixture, dielectric material test fixture and magnetic material test fixture
- Ultra-high measuring speed <3ms
- Open circuit/short circuit/load correction function
- Up to four component parameters can be selected in the electric meter mode. The inductance and DCR values can be measured and displayed simultaneously
- Auto component classification: Comparator function and Handler BIN classification function
- Support RS-232, GPIB, Handler, LAN, USB Host/Device interfaces
- PC connection data analysis software is available

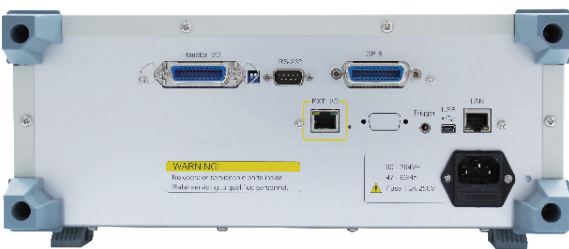

CE RS-232 LAN USB Host/Device GPIB Handler

Applications

Passive Components: Capacitor, Inductor, Resistor, Transformer, Ceramic resonator, Quartz Crystal

Semiconductor Components: The CV characteristics analysis of varactor diodes, Diodes

Dielectric Material: Estimation on permittivity and consumption tangent of plastic, ceramic and PCB

Other Components: Estimation of the impedance of PCB components

Accessories / Fixtures

Standard Accessories

- Power Cord
- User Manual (CD)

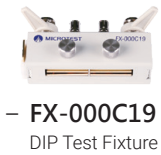

- FX-000C19
DIP Test Fixture

Optional Accessories

- PC Link software



- F423906A
Kelvin Clip Leads
(with BNC Box)



- F423503
DIP Test Fixture



- F423504
DIP Test Fixture



- FX-0000C6
Test Fixture



- F423905
SMD Test Fixture

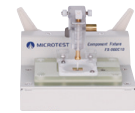

- FX-000C10
Bottom Electrode
SMD Test Fixture



- FX-000C11
SMD Tweezer Test
Leads



- FX-000C12
SMD Test Fixture

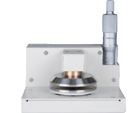

- FX-0000C7
Dielectric Material
Test Fixture



- FX-0000C8
Magnetic Material
Test Fixture



- FX-0000C9
Material Testing
Fixture

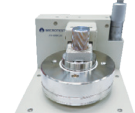

- FX-000C20
Liquid Dielectric
Material Test Fixture



- F420001
External Voltage
Bias
($\pm 200V/1MHz$)



- F420003
External Voltage
Bias ($\pm 40V/1MHz$)



- F663001 A/B/C
BNC Test Leads

Specifications

Model Name	6630-1	6630-3	6630-5	6630-10	6630-20	6630-30	6630-50
Test Frequency	10Hz-1MHz	10Hz-3MHz	10Hz-5MHz	10Hz-10MHz	10Hz-20MHz	10Hz-30MHz	10Hz-50MHz
Frequency Resolution	6-bit Frequency Input						
Frequency Output Accuracy	7ppm \pm 0.01%						
Basic Accuracy	\pm 0.05%						
AC Drive Level	Test Signal Voltage Level	10mV-2Vrms10mV - 2Vrms(Ro 100 Ω)/10mV - 1Vrms(Ro 25 Ω)					
	Voltage Minimum Resolution	1mV					
	Accuracy	ALC OFF: 10%* Voltage \pm 2mV ALC ON: 6%* Voltage \pm 2mV					
	Test Signal Current Level	200 μ A-20mArms					
	Current Minimum Resolution	10 μ A					
	Accuracy	ALC OFF: 10%* Current \pm 20 μ A ALC ON: 6%* Current \pm 20 μ A					
DC Drive Level	1V (fixed)						
Output Impedance	25 Ω , 100 Ω (switchable)						
Test Time (Fastest)	<3mS						
Measurement Parameters and Ranges	Z	0.000m Ω -9999.99M Ω					
	R, X	\pm 0.000m Ω -9999.99M Ω					
	Y	0.00000 μ S-999.999kS					
	G, B	\pm 0.00000 μ S-999.999kS					
	θ RAD	\pm 0.00000-3.14159					
	θ DEG	\pm 0.000 $^\circ$ -180.000 $^\circ$					
	Cs, Cp	\pm 0.00000pF-9999.99F					
	Ls, Lp	\pm 0.00nH-9999.99kH					
	D	0.00000-9999.99					
	Q	0.00-9999.99					
	Δ	\pm 0.00%-9999.99%					
	Rdc	0.00m Ω -99.9999M Ω					
	ϵ ' ϵ ''	0-100000					
	μ r' μ r''	0-100000					

General

Measurement Mode	Meter mode, list mode
Measurement Circuit	Series/Parallel
Correction	Open Circuit/Short Circuit/Load correction
List Mode	50 groups of Multi-steps setting (Each group contains up to 15 steps)
BIN	9
Comparator	ABS, Δ ABS, Δ %, OFF
Built-in Storage	100 sets LCR Meter setting documents, 50 sets list mode setting documents
USB Host Storage	LCR setting documents, list mode setting documents, BMP graphics
Trigger Test	Auto, Manual, RS-232, GPIB, Handler
Interface	RS-232, GPIB, Handler, LAN, USB Host/Device
Power Supply	Voltage 90-264Vac
	Frequency 47-63Hz
	Low power consumption: Maximum 30W (Nominal value)
Display	7.0" TFT, 800 \times 480 color screen
Environment	Temperature: 10 $^\circ$ C-40 $^\circ$ C, Humidity: \leq 80%
Dimension (W*H*D)	336 \times 147 \times 340mm
Weight	3kg

6630 Key Features

A Function Introduction



Four Parameters Displayed Simultaneously
7.0" TFT, 800 × 480 color screen, and four parameters can displayed simultaneously.



Correction
Before measuring the DUT, you should select "Correction" button to do open, short, and HF Load or SPOT Load correction.

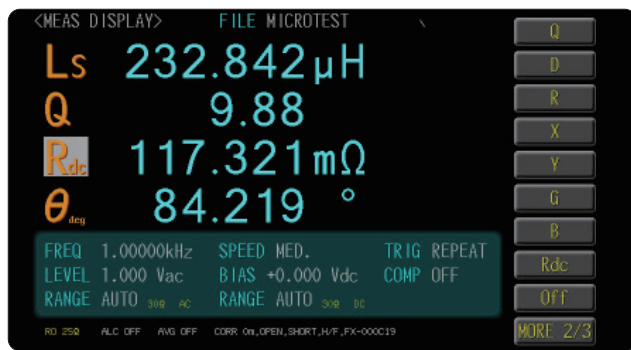

Measure Inductor (DCR)
Inductor coil turns and winding materials will affect DCR value. The key parameters for inductor are Ls / Lp / Q / SRF / DCR.

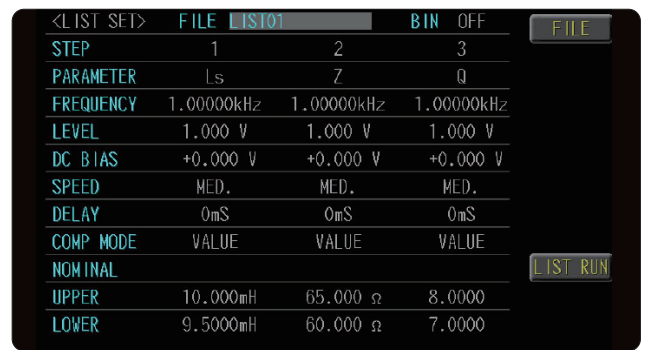

List Mode
50 groups of list mode setting (Each group contains up to 15 steps).

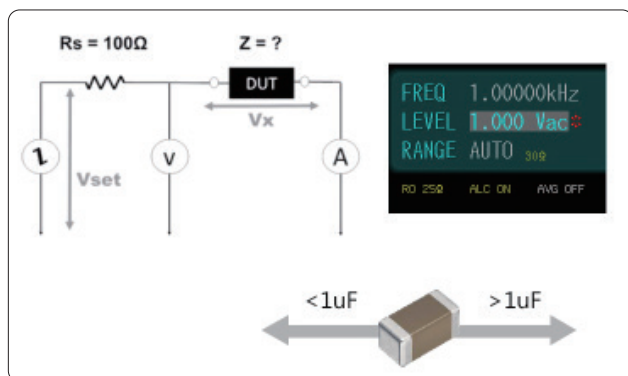

Output Impedance 25Ω/100Ω and Auto Level Control (ALC)
The key parameters for capacitance are Cs/Cp/D/Q/ESR/DC Bias Voltage.

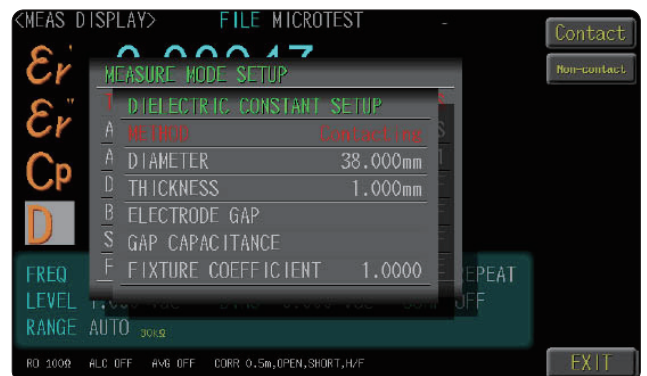

Dielectric Material Test Fixture (FX-0000C7)
Using the dielectric material test fixture for measuring PCB board or ceramic board. 6630 built-in formula to directly calculate the material dielectric value ϵ_r' , ϵ_r'' .



Liquid Dielectric Material Test Fixture (FX-000C20)
Using the liquid dielectric material test fixture for measuring the characteristics of electrochemical materials.



Magnetic Material Test Fixture (FX-0000C8)
Using the magnetic material test fixture for measuring of permeability of various toroidal cores or ferrite cores and electromagnetic shielding coating materials. 6630 built-in formula to directly calculate the permeability coefficient value μ' , μ'' .

B High productivity

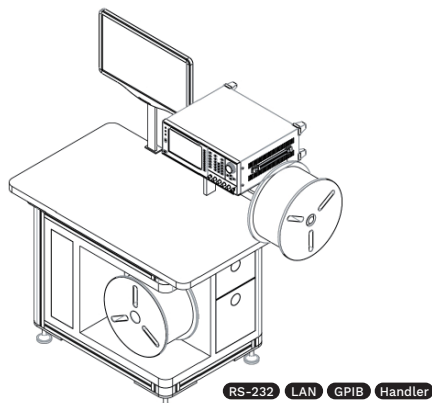

Automatic Production Line
Connect 6630 RS-232, LAN, GPIB or Handler to automatic machine (measuring speed < 3ms).

C Components

Passive Component



inductance
Ls / Lp / Q / SRF / I sat / I rms

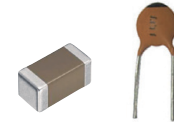

MLCC/capacitance
Cs / Cp / D / Q / ESR / DC Bias Voltage

Acoustic Components



Voice coil motor / Hearing aids
Ls / Q / Qm / SRF

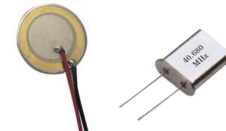

Piezoelectric element / quartz crystal
Cs / Cp / D / Fs / Fp

Material



Magnetic material
 μ' μ''

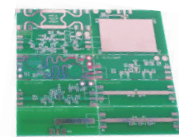

Dielectric / ceramics / Electrochemical materials
 ϵ' ϵ''

Wireless RF / Power Supply



Wireless charging
Ls / Q / SRF / DCR / Rs



NFC/low Freq. RFID
Ls / Q / SRF / DCR / Rs



battery
ESR / Cs / Cp / D

Semiconductor Components

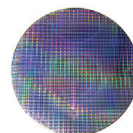

Wafer
C-V



LED Light board
Z / Cs / Cp / D



diode
Cs / Cp / D